

CORROSION IN AUTOMATIC SPRINKLER SYSTEMS

Table of Contents

| | Page |
|--|------|
| 1.0 SCOPE | 3 |
| 1.1 Hazard | 3 |
| 1.2 Changes | 3 |
| 2.0 LOSS PREVENTION RECOMMENDATIONS | 3 |
| 2.1 Introduction | 3 |
| 2.2 Operation and Maintenance | 3 |
| 2.2.1 Above-Ground Piping | 3 |
| 2.2.2 Below-Ground Piping | 6 |
| 3.0 SUPPORT FOR RECOMMENDATIONS | 6 |
| 3.1 Corrosion Chemistry | 6 |
| 3.1.1 Corrosion Process | 7 |
| 3.2 Supervisory Nitrogen Gas | 8 |
| 3.3 Trapped Air in Wet-Pipe Systems | 9 |
| 3.4 Graphitic Corrosion | 9 |
| 3.5 Galvanized Steel Pipe | 11 |
| 3.6 Weld Seam Corrosion and Leakage | 12 |
| 3.6.1 Wet-Pipe Systems | 13 |
| 3.6.2 Dry-Pipe or Preaction Systems | 15 |
| 3.7 Microbiologically Influenced Corrosion (MIC) | 16 |
| 3.7.1 Chemistry of MIC | 16 |
| 3.7.2 MIC Damage | 16 |
| 3.7.3 Industry Position and Current Standards | 16 |
| 3.7.4 MIC Assessment | 16 |
| 3.7.5 MIC Treatment | 17 |
| 3.8 Chlorinated Polyvinyl Chloride (CPVC) | 17 |
| 3.8.1 Environmental Stress Cracking (ESC) Mechanism | 18 |
| 3.9 Loss History | 18 |
| 3.10 Illustrative Losses | 18 |
| 3.10.1 Sprinkler Leakage Due to Corrosion in a Pipe Coupling | 18 |
| 3.10.2 Pinhole Leaks Over Data Processing Center | 18 |
| 3.10.3 Underground Fire Main Break Due to Corrosion | 18 |
| 4.0 REFERENCES | 18 |
| 4.1 FM Global | 18 |
| 4.2 Other | 18 |
| APPENDIX A GLOSSARY OF TERMS | 19 |
| APPENDIX B DOCUMENT REVISION HISTORY | 19 |

List of Figures

| | |
|---|----|
| Fig. 1. Example of wet sprinkler piping arranged with an automatic air-release valve | 5 |
| Fig. 2. Schematic illustration of iron (Fe) corrosion in water | 7 |
| Fig. 3. Development of corrosion | 8 |
| Fig. 4a. Galvanized steel pipe half-filled with tap water in house air after nearly six weeks' exposure | 8 |
| Fig. 4b. Galvanized steel pipe half-filled with compressed nitrogen after nearly six weeks' exposure | 9 |
| Fig. 5. Leakage section of a pipe where the air gap filled approximately 40% of the volume in a wet-pipe system | 9 |
| Fig. 6. Leakage sites of a wet pipe system due to trapped air | 10 |

| | |
|--|----|
| Fig. 7. Ruptured underground water main (identified as gray cast iron, 8 in. [20.3 cm] diameter) with cement lining on its inside diameter | 10 |
| Fig. 8. Cross section for part of the water main in Figure 7 | 11 |
| Fig. 9a. Tubercles that formed inside a galvanized steel sprinkler pipe (4 in. [10 cm] diameter) | 11 |
| Fig. 9b. Corrosion at the base of a tubercle, which ultimately led to through-wall leakage | 12 |
| Fig. 10. NPS 4 galvanized steel pipe (4.5 in. [11.4 cm] OD) with through-wall leakage | 12 |
| Fig. 11a. Leakage on an NPS 2½ steel sprinkler pipe in a wet pipe system; arrows indicate the weld seam leakage site and the location of the weld seam | 13 |
| Fig. 11b. Leakage on an NPS 2½ steel sprinkler pipe in a wet pipe system after removal of corrosion products; preferential attack surrounding the weld seam is severe | 14 |
| Fig. 12. Preferential grooving corrosion on a pipe weld seam with a .04 in. (1 mm) pinhole leak in a wet pipe system, after removing corrosion products inside an NPS 3 pipe | 14 |
| Fig. 13. Grooving corrosion of a longitudinal through-wall leakage in a galvanized steel pipe along its weld seam in a preaction | 15 |
| Fig. 14. Preferential grooving corrosion attack surrounding the weld seam area for a preaction system, near the pipe's 6 o'clock (bottom) installed position | 15 |
| Fig. 15. Corroded steel pipe with many tubercles inside | 17 |

List of Tables

| | |
|---|---|
| Table 1. Guideline for Retaining Pipe Based on Extent of Corrosion Damage | 4 |
|---|---|

1.0 SCOPE

This data sheet provides recommendations that are intended to address the prevention and control of corrosion in automatic sprinkler system piping.

1.1 Hazard

Internal corrosion in a sprinkler system can result in partial or full blockage, reducing water flow capacity and severely undermining the system's ability to provide reliable fire protection. Corrosion can also result in pinhole leaks, creating impairments to fire protection systems and damage to equipment and contents beneath the piping.

1.2 Changes

October 2016. This document has been completely revised. Major changes include the following:

- A. The title of the document was changed from "Prevention and Control of Internal Corrosion in Automatic Sprinkler Systems" to "Corrosion in Automatic Sprinkler Systems".
- B. Updated guidance based on new research.
- C. Added guidance on installing a nitrogen generator for dry and preaction systems.
- D. Reorganized the document to provide a format that is consistent with other data sheets.

2.0 LOSS PREVENTION RECOMMENDATIONS

2.1 Introduction

Most sprinkler system corrosion can be traced to the presence of water and air within the systems. Steel sprinkler piping will rust and corrode in the presence of water and oxygen. In typical wet sprinkler systems, oxygen in the water and trapped air is consumed over a relatively short period of time and the corrosion process ceases until fresh air or water is reintroduced into the system. In typical dry sprinkler systems where compressed air is used as the supervisory gas, the presence of water in the piping will result in rapid corrosion of the system.

The recommendations in this data sheet are intended to do the following:

- A. Provide guidance on preventing corrosion in new or existing wet, dry, deluge, and preaction sprinkler systems.
- B. Provide proper diagnosis of corrosion cases involving sprinkler systems.
- C. Keep sprinkler system piping affected by corrosion free of obstructions.
- D. Minimize the damage from possible sprinkler system leakage.

Use FM Approved equipment, materials, and services whenever they are applicable and available. For a list of products and services that are FM Approved, see the *Approval Guide*, an online resource of FM Approvals.

2.2 Operation and Maintenance

2.2.1 Above-Ground Piping

2.2.1.1 Use new, clean pipe, sprinklers, and components for all sprinkler system installations and retrofits. Ensure metal components are compatible.

2.2.1.1.1 If pipe is suspected of contamination prior to installation, disinfect the internal surfaces of the pipe with a solution of isopropyl alcohol or equivalent disinfectant. Do not use chlorine for disinfecting purposes. After disinfecting, cap pipe ends to prevent recontamination.

2.2.1.2 Pipe, sprinklers, and components awaiting installation should not be stored outdoors. If outdoor storage is unavoidable, place caps on pipe ends to prevent water and foreign material from entering.

2.2.1.3 Use Schedule 40 (or equivalent thickness) pipe for wet, dry, and pre-action systems installed over occupancies deemed sensitive to leaks.

2.2.1.4 Check sprinkler systems that exhibit pinhole leaks or show other signs of corrosion (scale, tubercles, or other deposits) for obstructed waterways in pipes, valves, and sprinklers in accordance with Data Sheet 2-81, *Fire Protection System Inspection, Testing, and Maintenance*. Conduct obstruction investigations promptly as the adequacy of the sprinkler system is in question.

- A. Inspect pipe using a video camera-based borescope. Inspect a sufficient sample of piping to ensure there are no obstructions present.
- B. If investigation reveals obstructions of the waterway, conduct a full flushing of the sprinkler system piping in accordance with the procedures in Data Sheet 2-81.
- C. Replace any section of piping that contains obstructions that are not dislodged by flushing procedures.

2.2.1.5 Have a metallurgical examination performed on a sample of the affected pipe or component to determine the type and extent of corrosion mechanism involved.

2.2.1.6 Visually inspect the system for waterway obstruction annually until it is determined the corrosion has been brought under control. This will help to monitor the condition of the sprinkler system and identify the formation of any tubercles, scale, or biological growth in the system.

2.2.1.7 Replace any section of pipe with a remaining wall thickness of less than that shown in Table 1.

Table 1. Guideline for Retaining Pipe Based on Extent of Corrosion Damage

| Pipe Schedule (or Equivalent Thickness) | Percentage of Wall Remaining in Any Single Pit |
|---|--|
| Schedule 40 | 25% or more |
| Schedule 10 | 50% or more |
| Schedule 5 | 75% or more |
| Hybrid Schedule | 75% or more |

Note: The information in this table provides a working guide for determining whether piping should be retained or replaced. It is based on engineering judgment and several cases of corrosion examined by FM Global. This guidance is intended to identify sections of pipe in which, because of wall thinning or the extent and depth of pitting, pipe failure or a pinhole leak could develop in a relatively short period of time. It is not intended to reflect the remaining useful life of a pipe.

2.2.1.8 Remove trapped air from wet-pipe sprinkler systems. Install minimum 1/2 in. (13 mm) FM Approved automatic air-release valves or FM Approved manual valves at the system high points. Remove the air after each time the system is drained and refilled (see Figure 1).

- A. Install an FM Approved pressure-relief valve of not less than ¼ in. (6.4 mm) in size (preferably at the riser or inspector's test connection) to relieve pressure increases caused by thermal expansion.
- B. Set the relief valve to operate at pressures greater than the maximum rated working pressure of the system (175 psi [12 bar] typical).

2.2.1.9 Water Source

- A. Avoid using untreated water as the source of sprinkler water.
- B. Do not use chemical cleaners or corrosion inhibitors. Pipe cleaning treatments and corrosion inhibitors have proven to be problematic when used in fire protection systems.
- C. Ensure that incompatible chemicals (e.g., organic fluid, pipe-cutting oil, adhesive, paint, antifreeze) do not come into contact with CPVC pipe. The manufacturer of installed CPVC should be consulted for a list of incompatible products.

2.2.1.10 Dry-Pipe, Preaction, and Deluge Systems

2.2.1.10.1 Dry-Pipe and Preaction Systems Using Nitrogen

- A. Pressurize the system using an FM Approved nitrogen generator. Alternatively, nitrogen cylinders may be used, or another suitable supply if compressed air is provided as backup.
- B. Black steel pipe is acceptable in dry-pipe and preaction sprinkler systems if nitrogen will be used throughout the life of the system. If it will not, use galvanized steel pipe.

2.2.1.10.2 Dry-Pipe and Preaction Systems Not Using Nitrogen, and Deluge Systems

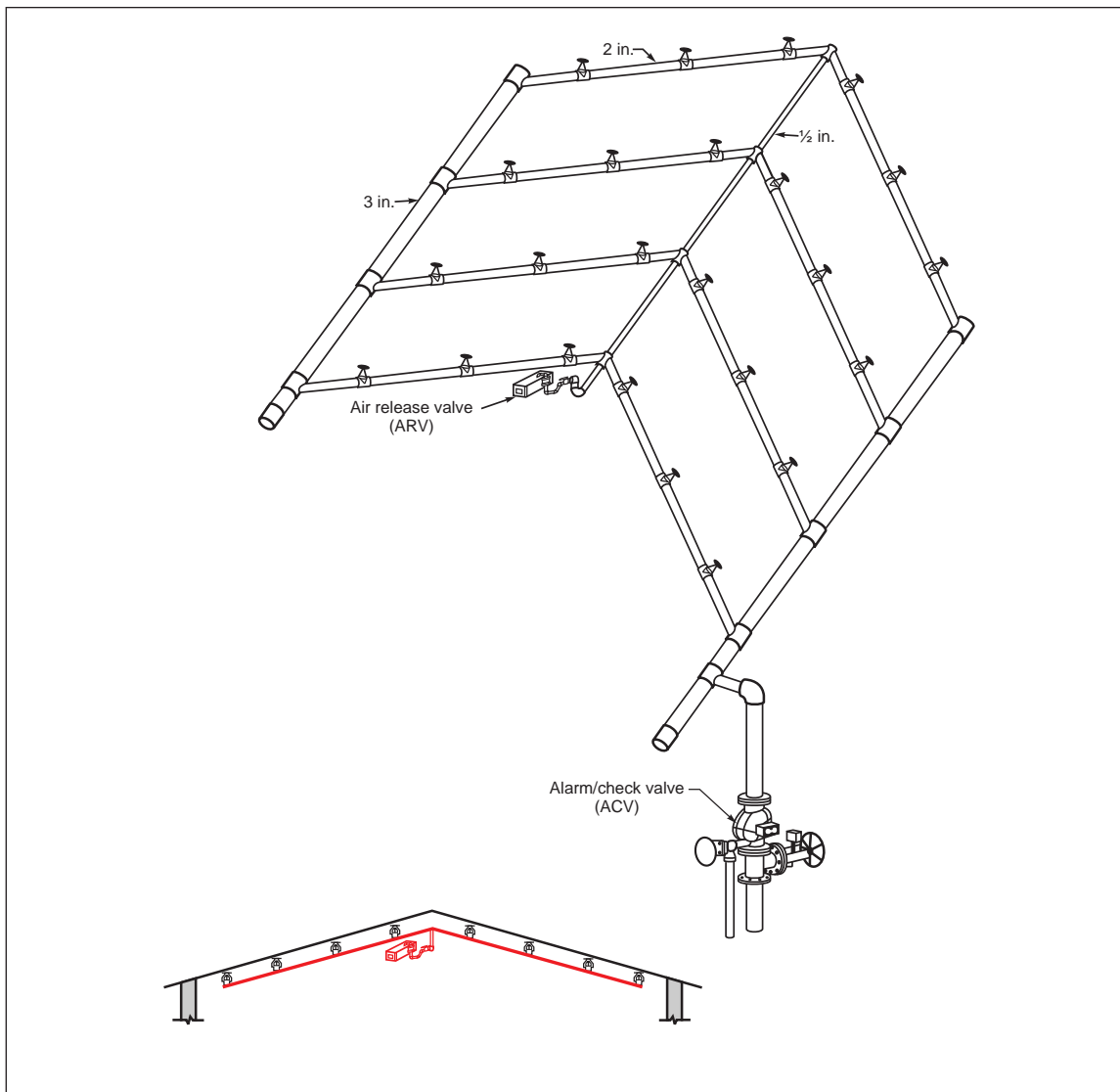

Fig. 1. Example of wet sprinkler piping arranged with an automatic air-release valve

- A. Use galvanized steel pipe.
- B. Install pipe with proper pitch per Data Sheet 2-0 to promote drainage of all testing water and water vapor condensate within piping.
- C. Install low-point drains as required to remove all water that can be trapped in these systems following system activation or during testing.
- D. Keep low-point drains (including those at the riser) clean, and drain condensate at the frequency required to prevent water accumulation.
- E. Avoid the use of rolled groove joints. Rolled groove joints in a dry sprinkler system promote water accumulation that can result in corrosion sites.
- F. In humid regions or in areas that are subject to rapid drops in temperature, install an air-drying system so the dew point temperature of the supply air is 20°F (6°C) below the lowest expected room temperature for the location where the system will be installed. Check air-drying systems at regular intervals as needed to prevent saturation of the drying media and excessive humid air from entering the system.
- G. Fix air leaks to keep system as tight as possible.

H. Orient longitudinal pipe weld seam toward building roof; at least 45° in relationship to the floor (for reference, the weld line points to the floor at 0°) to mitigate pipe weld seam corrosion.

I. Keep piping dry throughout the year (i.e., do not alternate between wet and dry systems).

2.2.2 Below-Ground Piping

The deterioration of underground mains due to corrosion is a significant risk to the reliability of the connected fire protection systems. A failure of the underground piping can take the fire protection systems out of service, and a failure during a fire can result in a total loss of fire protection. Most underground pipe corrosion involves exterior corrosion of cast and ductile iron piping. Internally corroded underground piping is rare due to the use of lining materials such as cement to protect the underlying iron pipe.

2.2.2.1 Avoid installing iron or steel pipe under coal piles, in cinder fill, or wherever acids, alkalis, pickling liquors, etc. can penetrate the soil.

2.2.2.2 In locations where the water table is high or the soil is corrosive, install FM Approved non-metallic underground pipe.

2.2.2.3 When a leak caused by corrosion occurs, determine the extent of the corrosion. For exterior corrosion, uncover several representative sections of buried pipe and check for signs of corrosion. To determine the best locations to excavate, use soil test bores to locate wet or corrosive soil conditions.

2.2.2.4 Replace underground piping where it shows signs of significant corrosion or has developed through-wall leaks.

3.0 SUPPORT FOR RECOMMENDATIONS

While corrosion in metals takes many forms, it is usually classified using one of the following terms:

- Uniform (or general) corrosion
- Galvanic (or two-metal) corrosion
- Pitting corrosion
- Crevice corrosion
- Selective leaching
- Erosion corrosion
- Environmentally induced cracking
- Intergranular corrosion
- Microbiologically influenced corrosion (MIC)

It should be noted that MIC is a corrosion phenomenon that has been studied relatively recently and can lead to pitting corrosion and/or failure. For the purposes of this document, discussion of corrosion specifically focuses on issues in fire protection systems.

3.1 Corrosion Chemistry

Corrosion involves the reaction between a metal or alloy and its environment. It is an irreversible interfacial reaction that causes the gradual deterioration of a metal surface by water (or moisture) and corrosive chemicals. In aqueous or humid environments, corrosion is an electrochemical reaction; it involves electron (e⁻) transfer between anodic and cathodic reaction sites. For corroding metals, the anodic reaction is the oxidation (i.e., loss of electrons) of a metal to its ionic state.

| | | |
|--------------------------|-----------------------------------|-------|
| <i>Anodic reactions:</i> | $M \Rightarrow M^{n+} + ne^{-}$ | (4-1) |
| Examples: | | |
| | $Fe \Rightarrow Fe^{2+} + 2e^{-}$ | (4-2) |
| | $Zn \Rightarrow Zn^{2+} + 2e^{-}$ | (4-3) |
| | $Cu \Rightarrow Cu^{2+} + 2e^{-}$ | (4-4) |
| | $Al \Rightarrow Al^{3+} + 3e^{-}$ | (4-5) |

The cathodic reaction is a reduction (i.e., gain of electrons) process. For metal corrosion, cathodic reactions, such as reactions 4-6 to 4-8, are frequently encountered. In acid solutions, hydrogen evolution and oxygen reduction reactions (reactions 4-6 and 4-7) are the main cathodic reactions. In neutral or basic pH solutions, oxygen reduction reaction (reaction 4-8) is the primary cathodic reaction.

| <i>Cathodic reactions:</i> | | |
|--|---|-------|
| Hydrogen evolution | $2\text{H}^+ + 2\text{e}^- \Rightarrow \text{H}_2(\text{g})$ | (4-6) |
| Oxygen reduction (acid solution) | $\text{O}_2 + 4\text{H}^+ + 4\text{e}^- \Rightarrow 2\text{H}_2\text{O}$ | (4-7) |
| Oxygen reduction (neutral or basic solution) | $\text{O}_2 + 2\text{H}_2\text{O} + 4\text{e}^- \Rightarrow 4\text{OH}^-$ | (4-8) |

Figure 2 shows a schematic illustration of iron (Fe) corrosion in water. The Fe dissolves into Fe^{2+} at the anode and liberates electrons (e^-) reacting with O_2 and water to form hydroxide ions (OH^-) at the cathode (oxygen reduction reaction). In general, when a fire protection system (FPS) is supplied with sprinkler water containing oxygen, corrosion of steel or galvanized steel pipe (anodic reaction) in the FPS will occur and continue until oxygen in the water (cathodic reaction) is depleted by the corrosion reactions.

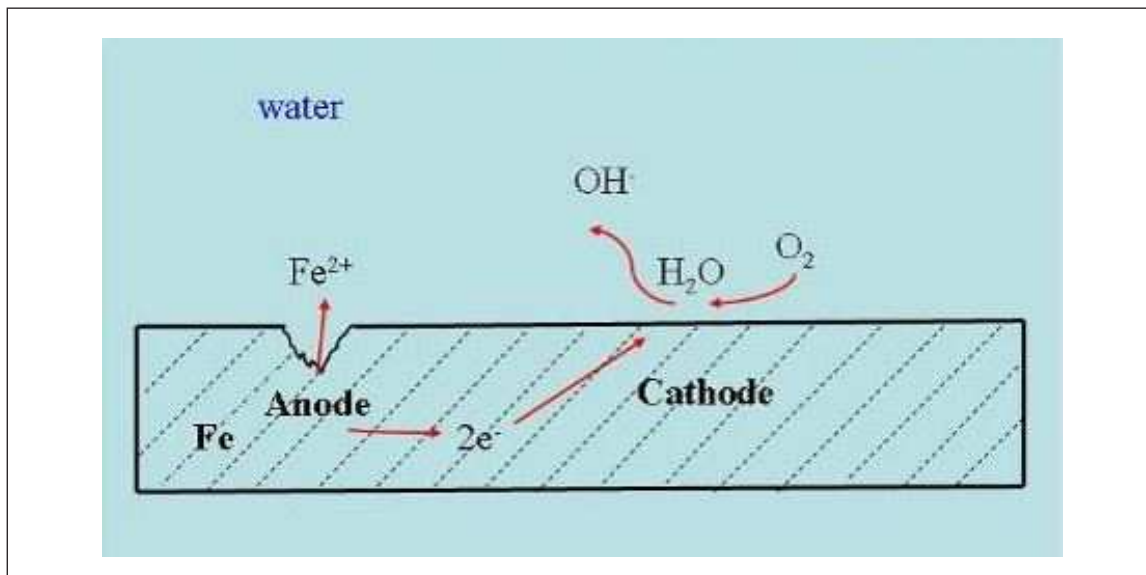

Fig. 2. Schematic illustration of iron (Fe) corrosion in water

3.1.1 Corrosion Process

Corrosion is a natural process that converts a refined metal to a more stable form, such as oxide, hydroxide, or sulfide. It is the gradual destruction of materials by chemical reaction with their environment.

In the most common use of the word, “corrosion” means electrochemical oxidation of metal in reaction with an oxidant such as oxygen or sulfur. Rusting (the formation of iron oxides) is an example of electrochemical corrosion. This type of damage typically produces oxide(s) or salt(s) of the original metal, and results in a distinctive orange coloration. Corrosion degrades the useful properties of materials and structures, including strength, appearance, and permeability to liquid and gas.

Many structural alloys corrode merely from exposure to moisture in air, but the process can be strongly affected by exposure to certain substances. Corrosion can be concentrated locally to form a pit or it can extend across a wide area, more or less uniformly corroding the surface (Figure 3).

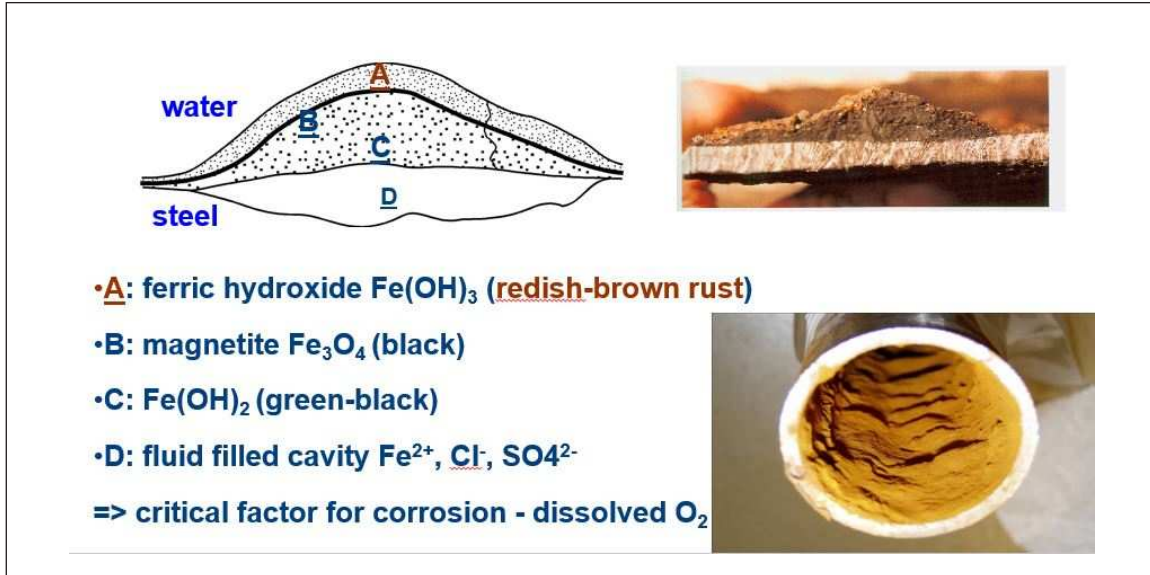

Fig. 3. Development of corrosion

3.2 Supervisory Nitrogen Gas

One corrosion mitigation approach is to fill dry-pipe or preaction systems with nitrogen gas. Doing so can remove oxygen, thereby decreasing oxygen-related electrochemical reactions. Based on the results of several field trials, this technique could mitigate corrosion in dry systems. FM Global testing has shown that carbon steel using air corrodes 20 times faster than when using nitrogen.

Figures 4a and 4b are photographs of galvanized steel pipe half-filled with tap water in house air (4a) and in compressed nitrogen (4b) after nearly six weeks' exposure. Whitish zinc corrosion products covered the bottom half of the house air-filled pipe in Figure 4a, but only limited zinc corrosion products covered the bottom half of the compressed nitrogen-filled pipe (Figure 4b). This result indicates that compressed nitrogen can reduce corrosion of galvanized steel pipe containing trapped water.



Fig. 4a. Galvanized steel pipe half-filled with tap water in house air after nearly six weeks' exposure



Fig. 4b. Galvanized steel pipe half-filled with compressed nitrogen after nearly six weeks' exposure

3.3 Trapped Air in Wet-Pipe Systems

Figure 5 shows the section of a pipe in which the air gap filled approximately 40% of the volume in a wet pipe system, providing the oxygen source for steel pipe corrosion. The through-wall leakage site is indicated and the two parallel lines point to the air pocket boundary in the pipe. Note the significant tuberculation, corrosion, and deposit buildup in the bottom half of the pipe. The arrow points to a large tubercle, beneath which was the site of the leakage.

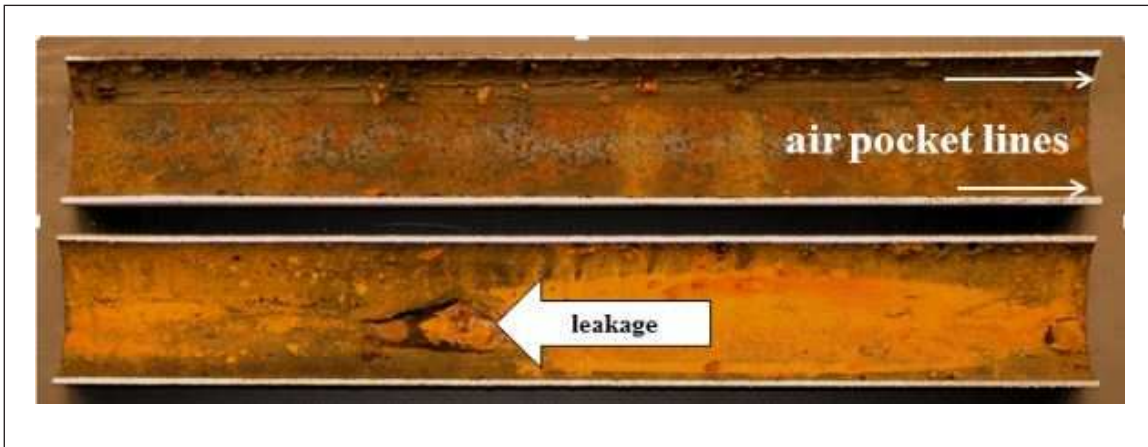

Fig. 5. Leakage section of a pipe where the air gap filled approximately 40% of the volume in a wet-pipe system

Figure 6 shows leakage sites of a wet pipe system due to trapped air. The leakage sites were at the left in the picture and near the roof bar joist as indicated. They were 10-15 ft to the left of the highest point in the system.

3.4 Graphitic Corrosion

Graphitic corrosion is a form of selective leaching in which one element is preferentially removed from an alloy, leaving a residue (often porous) of the elements that are more resistant to the particular environment. When graphitic corrosion of underground cast iron water pipe occurs, the iron (anode) matrix is replaced

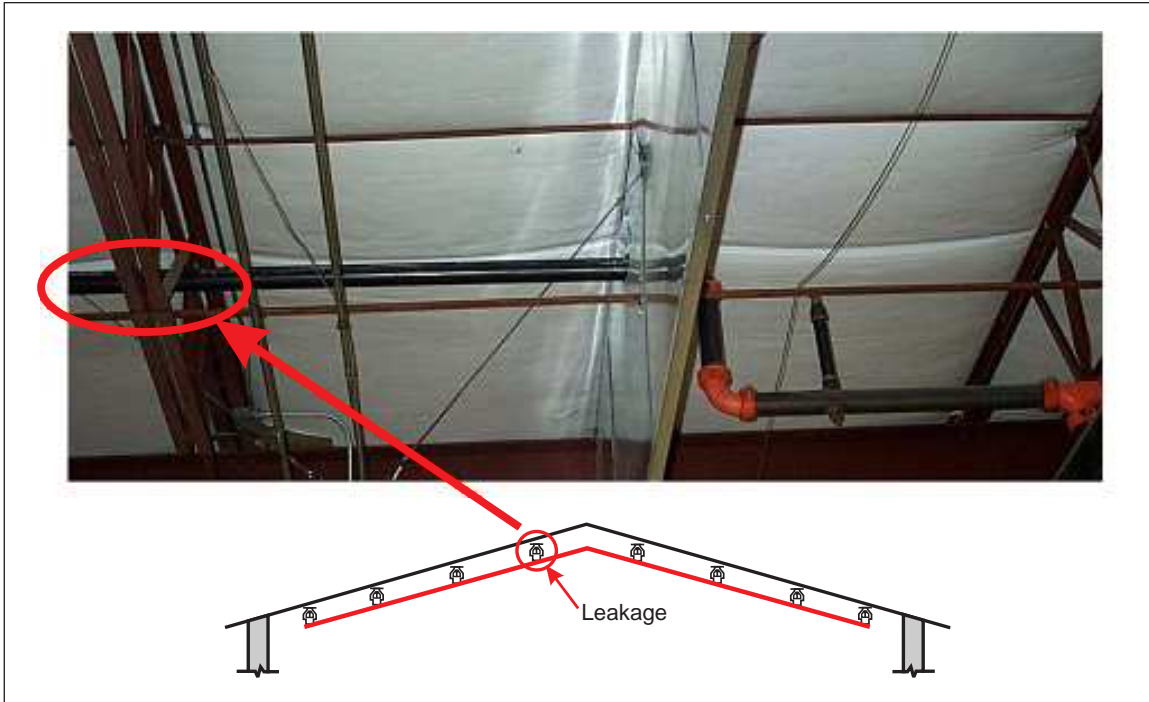

Fig. 6. Leakage sites of a wet pipe system due to trapped air

with a structurally weak graphite (cathode) structure. Note: Graphite particles are inherently present in all cast iron, including ductile iron. This typically occurs when the pipe is installed in wet soil conditions.

Figure 7 shows a ruptured underground water main (identified as gray cast iron, 8 in. [20.3 cm] diameter) with cement lining on its inside diameter. The circled area in Figure 7 shows graphitic corrosion on the outside surface of the main due to its exposure to mildly aggressive groundwater and soils. Generally, high moisture content in the surrounding soil is required for graphitic corrosion to occur.



Fig. 7. Ruptured underground water main (identified as gray cast iron, 8 in. [20.3 cm] diameter) with cement lining on its inside diameter

Figure 8 shows a cross section for part of the water main in Figure 7. It is noted that almost the entire wall thickness of the pipe has been penetrated by graphitic corrosion attack at the far left fracture surface, while the pipe's inside diameter surface with cement lining is in good condition.

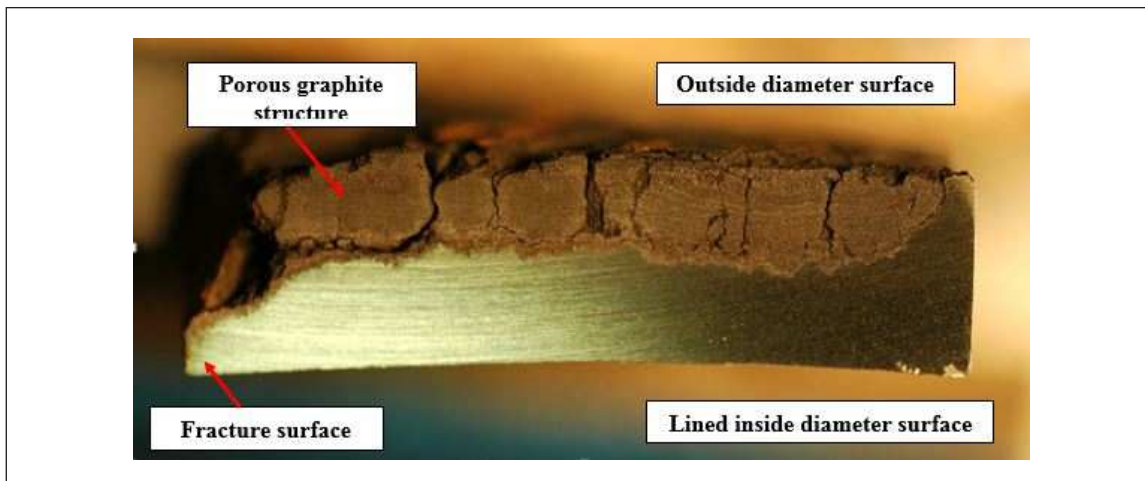

Fig. 8. Cross section for part of the water main in Figure 7

3.5 Galvanized Steel Pipe

Galvanized steel piping should be maintained “dry” (free of water). Internal corrosion will not occur if the piping is maintained dry. However, field-installed dry systems are subject to inadequate pitching and/or draining, trapping residual water from system commissioning and trip testing in the pipes (filled with air), resulting in high concentrations of dissolved oxygen and carbon dioxide in the trapped water. Dissolved oxygen (main cause) and carbon dioxide in water can increase corrosion rates for galvanized steel pipe (with zinc then steel corrosion).

Figure 9a shows tubercles and and Figure 9b shows pinhole leakage (circled) in galvanized steel sprinkler pipe from dry-pipe systems.



Fig. 9a. Tubercles that formed inside a galvanized steel sprinkler pipe (4 in. [10 cm] diameter)

Figure 10 shows NPS 4 galvanized steel pipe (4.5 in. [11.4 cm] OD) with through-wall leakage. Residual water filled about 40% of the pipe's volume in service. Under the waterline, white rust (zinc corrosion) and well over a dozen reddish-brown tubercles of various sizes are evident on the bottom half of the pipe. The corrosion remains localized. The top half of the pipe is free of corrosion while the bottom half has significant corrosion.



Fig. 9b. Corrosion at the base of a tubercle, which ultimately led to through-wall leakage

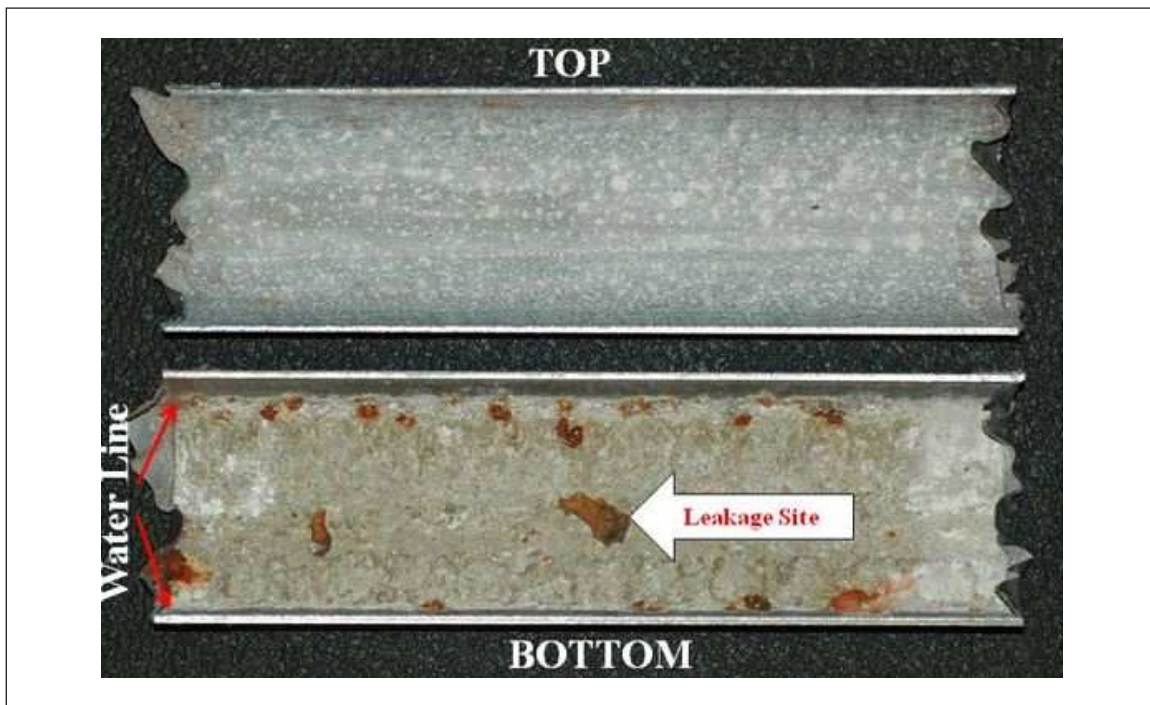

Fig. 10. NPS 4 galvanized steel pipe (4.5 in. [11.4 cm] OD) with through-wall leakage

It should be noted that new dry or preaction systems can develop through-wall corrosion pinhole leakage from 2 to 3 years after initial installation due to residual water causing corrosion in galvanized steel pipe.

3.6 Weld Seam Corrosion and Leakage

Preferential corrosion of weld seam (“grooving corrosion” or “knife-edge corrosion”) in steel pipe welded by electric-resistance welding (ERW) is a common failure mode for fire protection sprinkler systems. This kind of corrosion may be attributed to the formation of unstable iron sulfides along with high residual stresses and

microstructure changes around weld seam areas (causing anodic sites for corrosion to occur). Such areas are created during the pipe manufacturing process and they include the weld seam and other heat-affected zones. Corrosion and/or leakage of sprinkler pipe surrounding the weld seam area at the pipe bottom is frequently observed due to low corrosion resistance and near-bottom (6 o'clock) orientation of the weld seam. If the pipe weld is oriented above the 9 o'clock position toward the building roof (e.g., 9 o'clock to 12 o'clock positions), pitting corrosion can be expected to be less severe.

3.6.1 Wet-Pipe Systems

Figures 11a and 11b show leakage on an NPS 2½ steel sprinkler pipe in a wet pipe system. The weld seam leakage site and the location of the weld seam are indicated by arrows in Fig. 11b. Leakage on an NPS 2½ steel sprinkler pipe in a wet pipe system after removal of corrosion products; preferential attack surrounding the weld seam is severe

Figure 11b shows the waterside of the pipe in the region corresponding to the leakage site, after removal of corrosion products. Preferential attack surrounding the weld seam is severe.

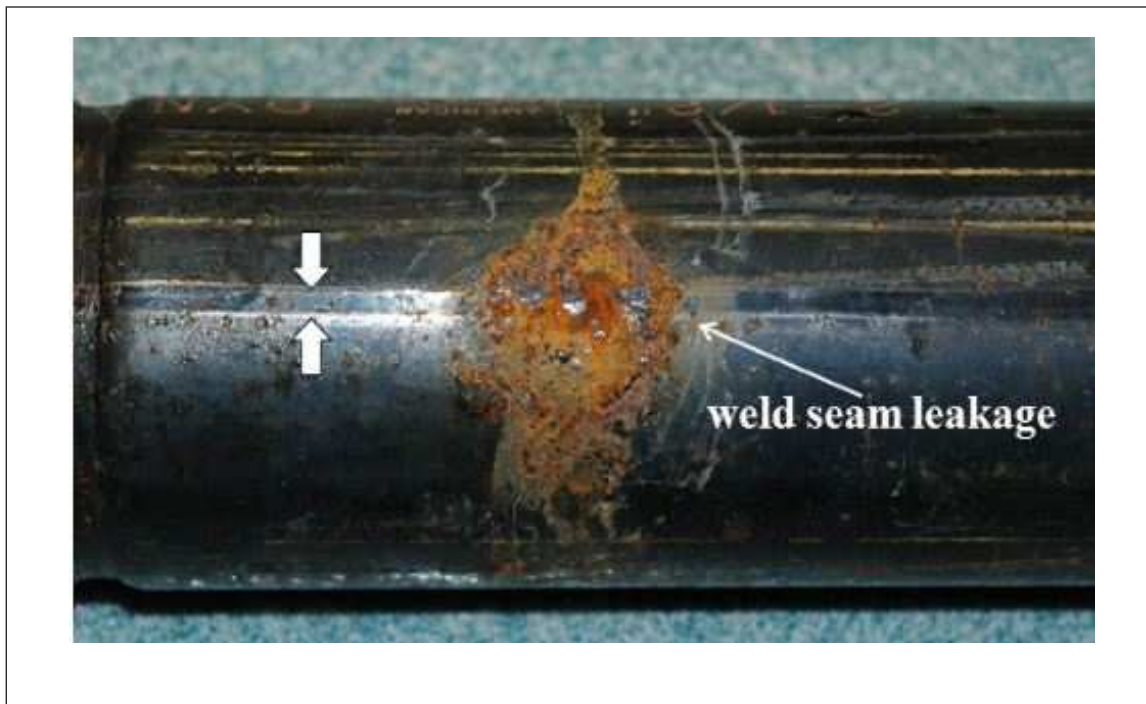

Fig. 11a. Leakage on an NPS 2½ steel sprinkler pipe in a wet pipe system; arrows indicate the weld seam leakage site and the location of the weld seam



Fig. 11b. Leakage on an NPS 2½ steel sprinkler pipe in a wet pipe system after removal of corrosion products; preferential attack surrounding the weld seam is severe

Figure 12 shows an example of preferential grooving corrosion on a pipe weld seam with a .04 in. (1 mm) pinhole leak in a wet-pipe system, after removing corrosion products inside an NPS 3 pipe.



Fig. 12. Preferential grooving corrosion on a pipe weld seam with a .04 in. (1 mm) pinhole leak in a wet pipe system, after removing corrosion products inside an NPS 3 pipe

3.6.2 Dry-Pipe or Preaction Systems

Figure 13 shows grooving corrosion of a longitudinal through-wall leakage in a galvanized steel pipe along its weld seam in a preaction system. The leak occurred beneath a large tubercle along the pipe's approximate 6 o'clock installed position. The arrow points a longitudinal through-wall leakage site on the pipe.



Fig. 13. Grooving corrosion of a longitudinal through-wall leakage in a galvanized steel pipe along its weld seam in a preaction

Figure 14 shows another preferential grooving corrosion attack surrounding the weld seam area for a preaction system, near the pipe's 6 o'clock (bottom) installed position.

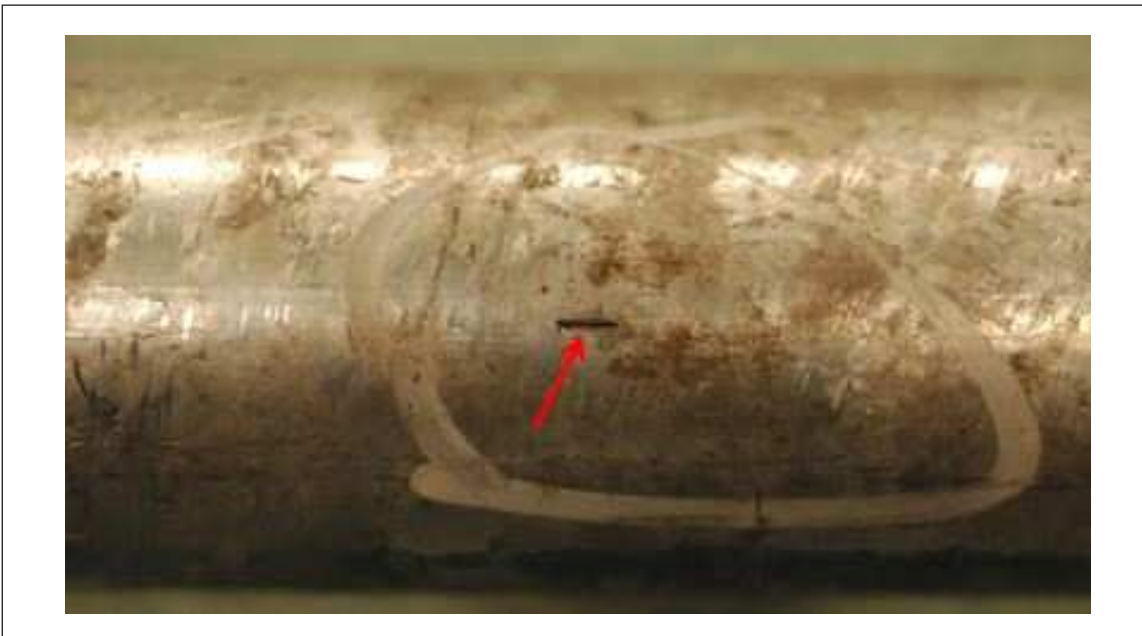

Fig. 14. Preferential grooving corrosion attack surrounding the weld seam area for a preaction system, near the pipe's 6 o'clock (bottom) installed position

3.7 Microbiologically Influenced Corrosion (MIC)

Microbiologically influenced corrosion (MIC) is corrosion associated with the presence and activities of microorganisms and/or their metabolites (the substances produced by their metabolisms). This type of corrosion is caused by the formation of biofilm on metal surfaces. Within the biofilm, metabolism activities of microorganisms (e.g., bacteria, fungi, algae) affect electrochemical conditions on the metal/solution interface, where metal corrosion can be initiated or accelerated.

Since 2001 FM Global has examined over 300 cases of failed sprinkler system components due to corrosion. The components ranged from pipes of various diameters, materials, and pipe schedules to fittings, sprinklers, and valves. Results have shown that MIC is responsible for 10% to 20% of the damage caused by corrosion in fire sprinkler systems.

3.7.1 Chemistry of MIC

The formation of a conditioning film on a metal surface enables planktonic (floating) bacteria from the bulk water to develop colonies and complex consortia with other types of bacteria and become sessile (anchored) on the metal surface. Representative microorganisms linked to MIC are described as follows:

Sulfate-reducing bacteria (SRB): SRB are anaerobic (live without oxygen) and they reduce sulfate (SO_4^{2-}) to sulfide (S^{2-}). SRB are commonly implicated in causing MIC.

Acid-producing bacteria (APB): APB are anaerobic but can also survive aerated environments and they create organic acids which can stimulate SRB growth.

Iron-oxidizing bacteria (IOB): IOB are aerobic (with oxygen) and they can oxidize ferrous ions II (Fe^{2+}) to form orange-red tubercles of iron oxides or hydroxides (Fe^{3+}).

Slime-forming bacteria (SFB): SFB bacterial form a biofilm.

Sulfur-oxidizing bacteria (SOB): SOB bacteria are aerobic and they oxidize sulfur to sulfate.

Nitrate-reducing bacteria (NRB): NRB reduce nitrate (NO_3^-) to ammonia (NH_3). Also, any given species may exhibit more than one of these traits.

It should be noted that SRB and APB are commonly implicated as groups of bacteria that cause MIC in fire protection systems, as well as corrosion failures in steel pipe.

3.7.2 MIC Damage

MIC is reported to be responsible for 10% to 20% of the damage to fire protection systems (FPS) caused by corrosion, or 10% to 30% of corrosion in all piping systems in the United States. Activities of microbes and corrosion of carbon steel piping systems may form tubercles or nodule deposits on pipe surfaces, leading to obstruction of water flow and blockage of valves or sprinklers in FPS when activated. It should be noted that stagnant water and dead ends of sprinkler piping in FPS can provide quiescent environments conducive to microbial activities. Under tubercles or nodule deposits, the pipe wall progressively deteriorates, most frequently by pitting or localized corrosion, until the wall is finally perforated and a pinhole leak develops.

3.7.3 Industry Position and Current Standards

MIC is an industry-wide concern and has gained the attention of many groups. Several organizations (NFFPA, EPRI, and European Fire Sprinkler Network) have published documents discussing corrosion issues in FPS. NFFPA 13 and NFFPA 25 include provisions for testing water supplies for MIC.

3.7.4 MIC Assessment

Microorganisms are ubiquitous, but detecting MIC-related bacteria in sprinkler water and/or corrosion product samples does not necessarily confirm that MIC has occurred in a fire protection system. Pinhole leakage caused by pitting corrosion underneath a tubercle is frequently observed, which could be influenced by microorganisms. However, pitting corrosion and pinhole leakage can also be caused by other types of corrosion mechanisms, such as non-microbial pitting under tubercles, crevice corrosion, aggressive water chemistry, metallurgical microstructures, and manufacturing issues.

It is necessary to evaluate chemical, microbiological, metallurgical, and operational data to identify biotic factors as primary contributors to corrosion damage. For fire protection systems, it is often difficult to distinguish between biotic (MIC) and abiotic (non-MIC) factors as both contribute to pitting corrosion and tubercles.

In many cases, the presence of MIC-related bacteria may exert some influence on corrosion in fire protection systems, but not as a major contributor. Therefore, it is necessary to evaluate all corrosion parameters before determining the causes of corrosion in FPS. For example, residual water and dissolved oxygen in galvanized steel pipe are the leading causes of corrosion and/or leakage for dry and preaction sprinkler systems, even though several types of bacteria can often be detected in their water supplies.

3.7.4.1 MIC Example

Figure 15 is an example of a 4 in. (10 cm) diameter corroded/leaking steel pipe with many tubercles formed inside the pipe. MIC caused by SRB was identified to be a likely contributing factor to the corrosion based on testing results of SRB immunoassay, lead acetate sulfide tests, water chemistry analyses, and corrosion/metallurgical evidence.



Fig. 15. Corroded steel pipe with many tubercles inside

3.7.5 MIC Treatment

Chemical treatment to mitigate MIC is not recommended because it can actually accelerate pipe corrosion if it is not properly performed. Instead, replacing the pipe is recommended.

3.8 Chlorinated Polyvinyl Chloride (CPVC)

Plastic materials have been widely used in a variety of processing and construction industries due to their corrosion-resistance properties, long-term durability, ease of production and installation, etc. However, plastic products do suffer degradation and failure in service.

CPVC pipe and fittings have been successfully used in fire protection systems for more than 30 years. Some compatibility issues between CPVC material and its service environments are known to exist. Exposure to such environments internally or externally can lead to premature cracking and failure of CPVC pipe.

3.8.1 Environmental Stress Cracking (ESC) Mechanism

Environmental stress cracking (ESC) is the most common cause of plastic failure. Absorption of organic chemicals into a plastic can reduce its yield strength. This absorption process is accelerated when the plastic is under applied stress (especially tensile stress). The absorbed organic chemicals, along with applied stress, weaken the intermolecular bonds of plastic, reducing the strength of the material.

Organic fluids with modest hydrogen bonding, such as aromatic hydrocarbons, halogenated hydrocarbons, ketones, aldehydes, esters, ethers, and nitrogen and sulfur containing compounds, can be absorbed into plastic with the assistance of applied stress. Examples of ESC agents include paints, adhesives, cleaning agents, lubricants, residual oil (including pipe cutting oil), solvent cements, plasticizers, inks, aerosol sprays, leak detection fluids, lacquers, surfactants, etc.

3.9 Loss History

A study of sprinkler leakage losses for the period 2001 to 2015 shows corrosion as the fourth largest cause of sprinkler leakage losses (by loss cost), preceded by freezing, mechanical injury, and defective equipment. While loss history has been relatively favorable, it shows internal corrosion of fire protection piping is a potential source of sprinkler leakage losses and a possible factor aggravating fire losses.

3.10 Illustrative Losses

3.10.1 Sprinkler Leakage Due to Corrosion in a Pipe Coupling

A bolt for a 2 in. (50 mm) grooved pipe coupling rusted to the point that the 75 psi city water pressure caused the bolt to break. This resulted in wet down of 71 pallet loads of pharmaceutical products in a warehouse. The suspected cause for the bolt rusting was a leak in the rubber seal onto the bolt for an extended period of time.

3.10.2 Pinhole Leaks Over Data Processing Center

Pinhole leaks developed in a Schedule 10 sprinkler piping system protecting a data processing center. The leaks damaged records and computer equipment.

3.10.3 Underground Fire Main Break Due to Corrosion

Four pipe breaks involving underground fire protection sprinkler piping occurred over a two week period at a leased metal products manufacturer. The pipe breaks were caused by corrosion of the 40 year old piping.

4.0 REFERENCES

4.1 FM Global

Data Sheet 2-0, *Installation Guidelines for Automatic Sprinklers*

Data Sheet 2-81, *Fire Protection System Inspection, Testing and Maintenance and Other Fire Loss Prevention Inspections*

Data Sheet 3-10, *Installation and Maintenance of Private Fire Service Mains and Their Appurtenances*

FM Global Research Technical Report 3040794, *Corrosion and Corrosion Mitigation in Fire Protection Systems*.

4.2 Other

British Standards Institute (BSI), *Fixed Firefighting Systems: Automatic Sprinkler Systems Design, Installation and Maintenance*. EN 12845:2004.

National Fire Protection Association (NFPA). NFPA 13, *Standard for the Installation of Sprinkler Systems*, 2016 edition.

National Fire Protection Association (NFPA). NFPA 25, *Standard for the Inspection, Testing, and Maintenance of Water-Based Fire Protection Systems*, 2014 edition.

VdS Schadenverhütung GmbH, *VdS CEA Guidelines for Sprinkler Systems: Planning and Installation*. VdS CEA 4001: 2005-09.

APPENDIX A GLOSSARY OF TERMS

FM Approved: Products and services that have satisfied the criteria for FM Approval. Refer to the *Approval Guide*, an online resource of FM Approvals, for a complete list of products and services that are FM Approved.

APPENDIX B DOCUMENT REVISION HISTORY

October 2016. This document has been completely revised. Major changes include the following:

- A. The title of the document was changed from "Prevention and Control of Internal Corrosion in Automatic Sprinkler Systems" to "Corrosion in Automatic Sprinkler Systems".
- B. Updated guidance based on new research.
- C. Added guidance on installing a nitrogen generator for dry and preaction systems.
- D. Reorganized the document to provide a format that is consistent with other data sheets.

May 2001. First published.