



PREACTION PAC
SPRINKLER VALVE ASSEMBLY®

with Notifier RP-2001 Releasing Control Panel

INSTALLATION, OPERATION, AND MAINTENANCE MANUAL

Serial Number _____

Date of Installation _____ Date of Commissioning _____



UNITED Fire Protection Corporation

1 Mark Road
Kenilworth, NJ USA 07033
908-688-0300
www.unitedfireprotection.com

Manual Part Number 10-500001-00C
Version 1.1
July 2011

INDEX

Section	Description	Page
	Index	i
	List of Figures	ii
	List Of Tables	iii
	Hazard Identification	iv
	Foreword	v
1	General	
1.1	Introduction	2
1.2	Features	2
1.3	Functional Description	5
1.4	Configurations	7
1.5	Options	7
1.6	Approvals	7
1.7	Applicable Standards	7
1.8	Applicable Manuals	7
1.9	FM Approved Assemblies	11
1.10	Installation	
1.10.1	Location	13
1.10.2	Unpacking, Placement, and Leveling	13
1.10.3	Serial Number	15
1.10.4	External Attachments	15
1.10.5	Prior To Placing In Service	21
1.10.6	Placing In Service	21
1.11	Operation	
1.11.1	Automatic	21
1.11.2	Manual	21
1.11.3	Restoring To Service	22
1.12	Inspection, Testing, and Maintenance	22
2	Victaulic Manual I-769P – Firelock NXT Preaction Valve	
3	General Air Products Manual OILLESSINST – Compressor	
4	Notifier Manual 52985 – RP-2001 Control Panel	

LIST OF FIGURES

Figure No.	Description	Page
1	Illustration - PREACTION-PAC Shown With Enclosure Doors Closed	1
2	Illustration - PREACTION-PAC Shown With Enclosure Doors Open	3
3	Diagram - Functional Description	4
4	Diagram – Overall Dimensions	13
5	Diagram - Location of Pallet Bolts and Leveling Feet	14
6	Diagram - Piping Attachment Details	16
7	Diagram - Terminal Strip Wiring Detail	18

LIST OF TABLES

Table No.	Description	Page
1.8.1	Items Applicable and Not Applicable in Section 2 – Victaulic Manual I769P – Firelock NXT Preaction Valve	8
1.8.2	Items Applicable and Not Applicable in Section 3 – General Air Products Manual OILLESSINST - Compressor	9
1.8.3	Items Applicable and Not Applicable in Section 4 – Notifier Manual 52985 – RP-2001 Control Panel	10
1.9.1	FM Approved Assemblies with Notifier NFS2-640 Control Panel	12

HAZARD IDENTIFICATION

Carefully read, understand, and follow instructions identified by these symbols.



The use of the word "DANGER" identifies an immediate hazard with a likelihood of death or serious personal injury if instructions, including recommended precautions, are not followed.



The use of the word "WARNING" identifies the presence of hazards or unsafe practices that could result in death, personal injury, or serious property damage if instructions, including recommended precautions, are not followed.



The use of the word "CAUTION" identifies possible hazards or unsafe practices that could result in personal injury or property damage if instructions, including recommended precautions, are not followed.



The use of the word "IMPORTANT" identifies special instructions, not related to hazards, that should be followed.

FOREWORD

This manual is written for those who install, operate and maintain United Fire Protection PREACTION-PAC sprinkler valve assemblies. The manual contains installation, operation, and maintenance information for these assemblies.



IMPORTANT

United Fire Protection assumes no responsibility for the installation, operation, or maintenance of any systems other than those addressed in this manual. The data contained in this manual is for information purposes only. United Fire Protection believes this data to be accurate at the time of publication, but the data is published and presented without any guarantee or warranty whatsoever. United Fire Protection disclaims any liability for any use that may be made of the data and information contained in this manual by any and all parties.



IMPORTANT

The United Fire Protection PREACTION-PAC sprinkler valve assembly is a vital part of the fire protection of any facility where these units are installed. Life safety and property protection depends on continuing proper operation of the assembly. The owner of the PREACTION-PAC is responsible for the condition of the assembly and its continued proper operation. United Fire Protection strongly recommends that all owners of PREACTION-PACs engage the services of qualified, trained fire protection professionals to design the system containing the assembly, and to install and maintain the assembly.

United Fire Protection PREACTION-PAC sprinkler valve assemblies are to be installed and maintained by qualified, trained personnel in accordance with:

- This Installation, Operation, and Maintenance Manual P/N 10-500001-00C.
- National Fire Protection Association No. 13, “Standard for the Installation of Sprinkler Systems.”
- National Fire Protection Association No. 25, “Standard for the Inspection, Testing, and Maintenance of Water-Based Fire Protection Systems.”
- National Fire Protection Association No. 70, “National Electrical Code®”.
- National Fire Protection Association No. 72, “National Fire Alarm Code®”.

Any questions on the information in this manual should be addressed to:

United Fire Protection Corporation
1 Mark Road
Kenilworth, NJ USA 07033
908-688-0300
www.unitedfireprotection.com

PREACTION-PAC
with NOTIFIER RP-2001 RELEASING CONTROL PANEL
INSTALLATION, OPERATION, AND MAINTENANCE MANUAL
P/N 10-500001-00C
VERSION 1.1 – JULY 2011

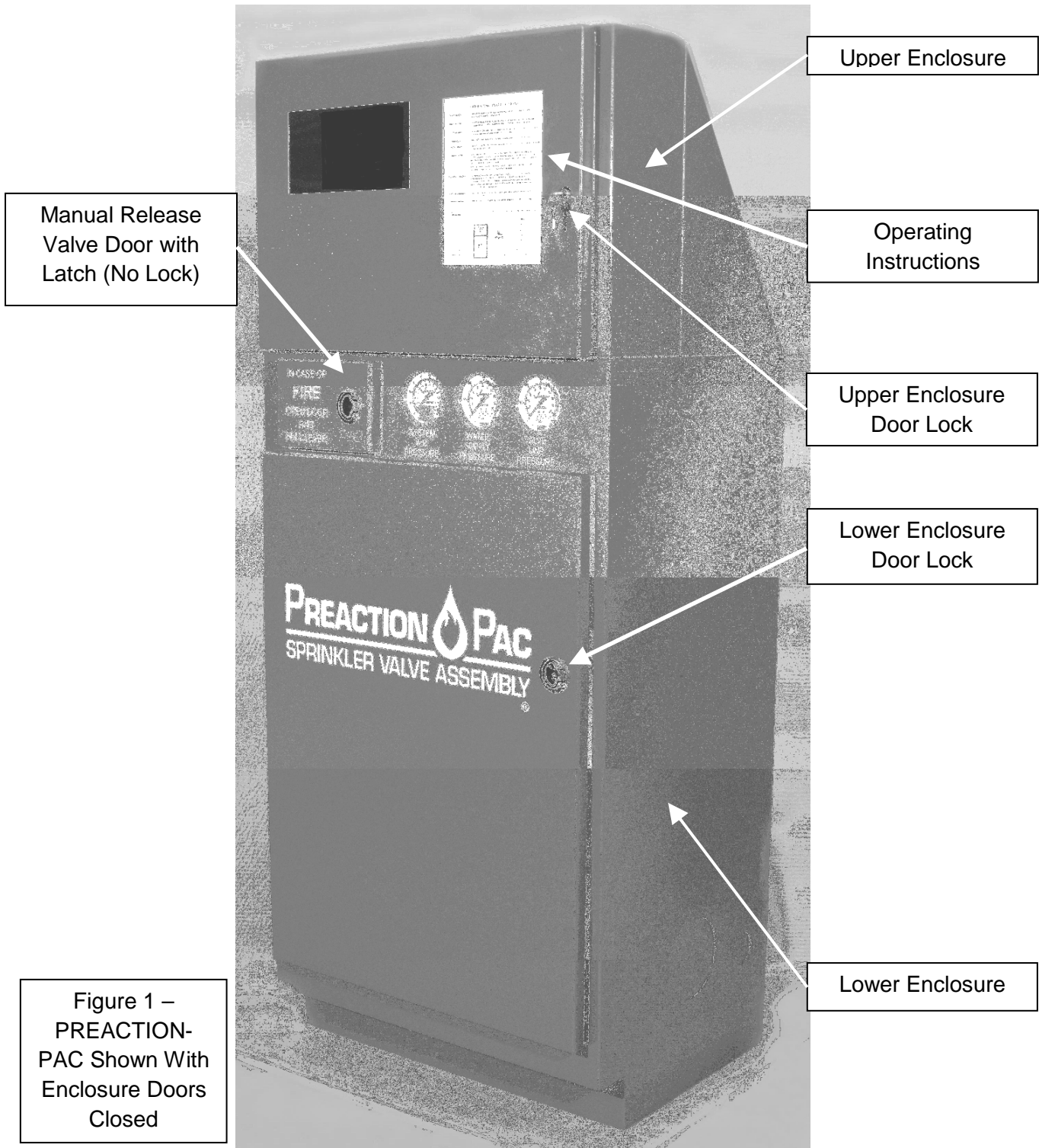

1. GENERAL

1.1. Introduction. The United Fire Protection PREACTION-PAC is a fully assembled and factory tested pre-action fire suppression system, including pre-action valve, trim, and control panel providing one complete zone of pre-action water sprinkler fire protection. All components are contained in two steel enclosures assembled one above the other. The system pressure gages and the required manual release handle are mounted on the front of the lower enclosure. The system detection and control panel is mounted behind a door in the upper enclosure with a clear polycarbonate window allowing visual access to the system indicators. Lockable latches on both doors permit authorized access to all system components. Both enclosures are finished in powder-coat red paint. Gasketing provides sealing of the enclosure doors. Knockouts permit easy attachment of external electrical conduits.

1.1.1. Pre-Action-Valve. The pre-action valve installed in the PREACTION-PAC is a low-differential, latched clapper valve that uses a unique direct-acting diaphragm to separate the system water supply from the system piping. The positive latching system uses the supply water pressure to hold the clapper shut. When the water pressure in the diaphragm chamber is released, the latch retracts from the clapper and the valve actuates. The low differential and unique latch and actuator design of the valve allows the valve to be self-resetting.

1.1.2. Piping. Water inlet pipe connections are located on the lower left and lower right sides and the upper right corner of the lower enclosure. (NOTE: Assemblies equipped with 1/2HP compressors do not have upper right corner inlet connection.) The unused inlets are left plugged. Grooved pipe is used for the inlet connection. The water outlet pipe connection is located at the top center of the lower enclosure, behind the upper enclosure. The drain connection is accessible within the lower enclosure, and knockouts are provided allowing exit of the drain from either side. All pipe connections are done in the lower enclosure.

1.1.3. Control Panel. A Notifier RP-2001 conventional detection releasing control panel is factory-installed in the upper enclosure. Programming for a basic pre-action system is factory programmed and tested. Additional programming may be necessary after installation to suit field conditions. This manual provides complete instructions for additional programming. All necessary internal wiring connections are factory-installed and tested.

1.1.4. Wiring. All wiring from the integral control panel to the valve solenoid and all switches is factory installed and tested. Wiring for compressor power and control is also factory installed and tested. All field wiring for control panel power, compressor power, detection circuits, notification appliance circuits, and circuits requiring contact closure is connected to terminal strips in the upper enclosure. No access to the lower enclosure is necessary to complete the wiring installation.

1.1.5. Compressor. The compressor for air pressurization of the pre-action sprinkler piping is pre-installed, wired and adjusted. Three sizes of compressor are available, depending on the volume of installed piping to be pressurized. The compressor is mounted using molded rubber mounts and bushings to minimize noise and vibration during motor operation. A compressor disconnect switch is located in the upper enclosure.

1.2. Features

1.2.1. Attractive and rugged metal enclosure. The entire enclosure is manufactured from steel with continuous welded seams. The lower enclosure is 12 gage, while the upper enclosure is 14 gage. Both enclosures are coated with red powder-coat paint inside and out. Continuous piano-style hinges attach the doors to the enclosures.

1.2.2. Easy-to-see gages on front of enclosure. Three pressure gages are mounted on the front of the lower enclosure, and are visible at all times. These gages monitor the air pressure in the system piping, the water supply pressure up to the pre-action valve, and the water pressure keeping the valve clapper piston closed.

1.2.3. Easy access to manual release valve. The emergency manual release ball valve is located behind a small unlocked door on the front of the lower enclosure. Operation of this ball valve opens the pre-action valve, filling the system piping with water. No power is necessary to accomplish this

PREACTION-PAC
with NOTIFIER RP-2001 RELEASING CONTROL PANEL
INSTALLATION, OPERATION, AND MAINTENANCE MANUAL
P/N 10-500001-00C
VERSION 1.1 – JULY 2011

operation. The key for the lower enclosure main door does not have to be available to accomplish this operation.

- 1.2.4. Lower and upper water inlet connections. The water inlet piping may attach to the lower enclosure either near the bottom on either side, or to a pre-piped upper inlet at the top of the lower enclosure. (NOTE: Assemblies equipped with 1/2HP compressors do not have upper inlet connection.)
- 1.2.5. Easy-to-follow instructions on enclosure front. System instructions, mounted behind clear plastic, are located on the front of the upper enclosure.
- 1.2.6. Space for required spare sprinkler heads and wrench. As required by NFPA 13, a built-in storage location for spare sprinkler heads and a sprinkler wrench is behind the door of the upper enclosure.
- 1.2.7. Separate mechanical and electrical enclosures. This allows mechanical and electrical trades to keep their work areas separate.

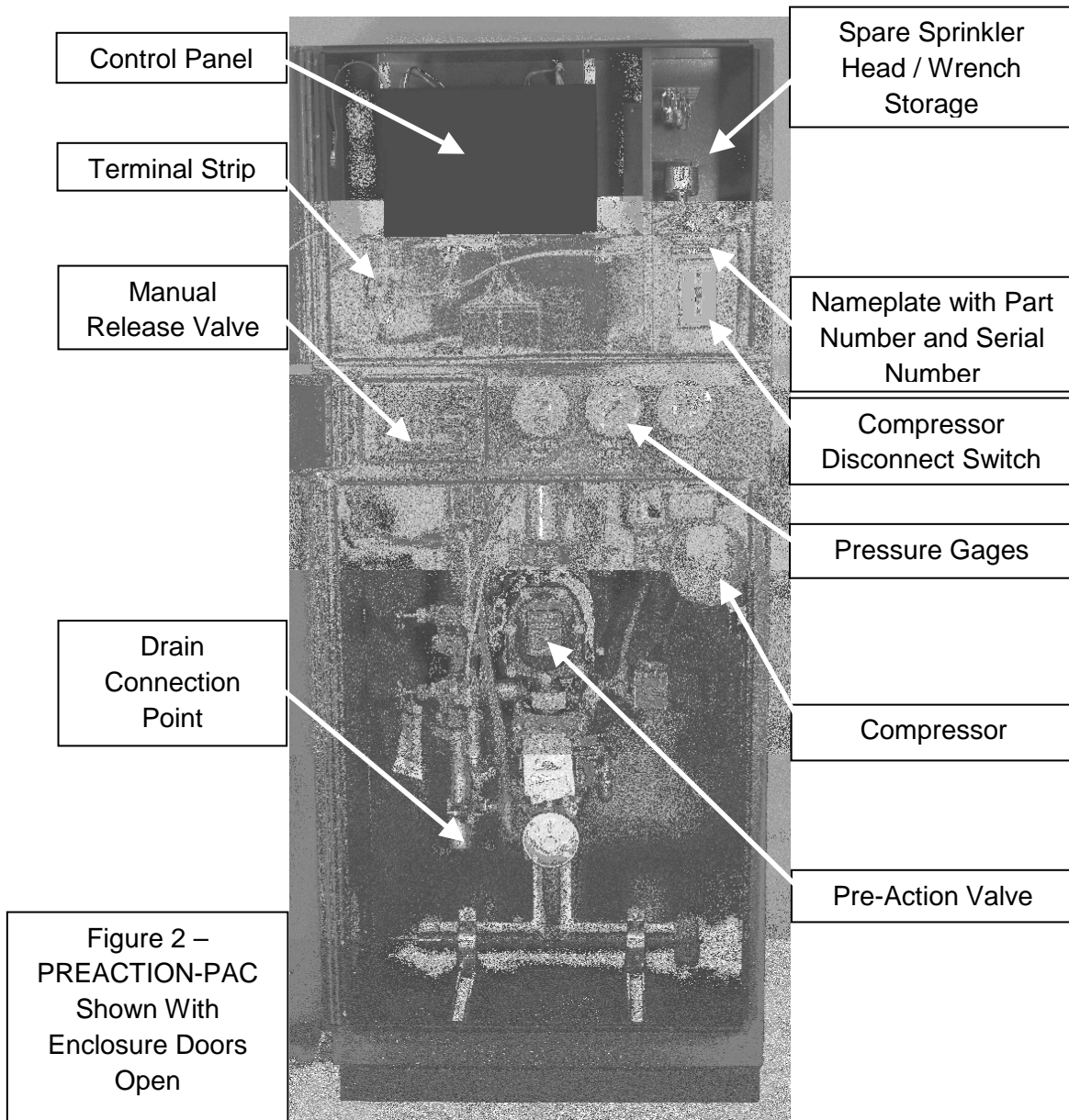

PREACTION-PAC
 with NOTIFIER RP-2001 RELEASING CONTROL PANEL
 INSTALLATION, OPERATION, AND MAINTENANCE MANUAL
 P/N 10-500001-00C
 VERSION 1.1 – JULY 2011

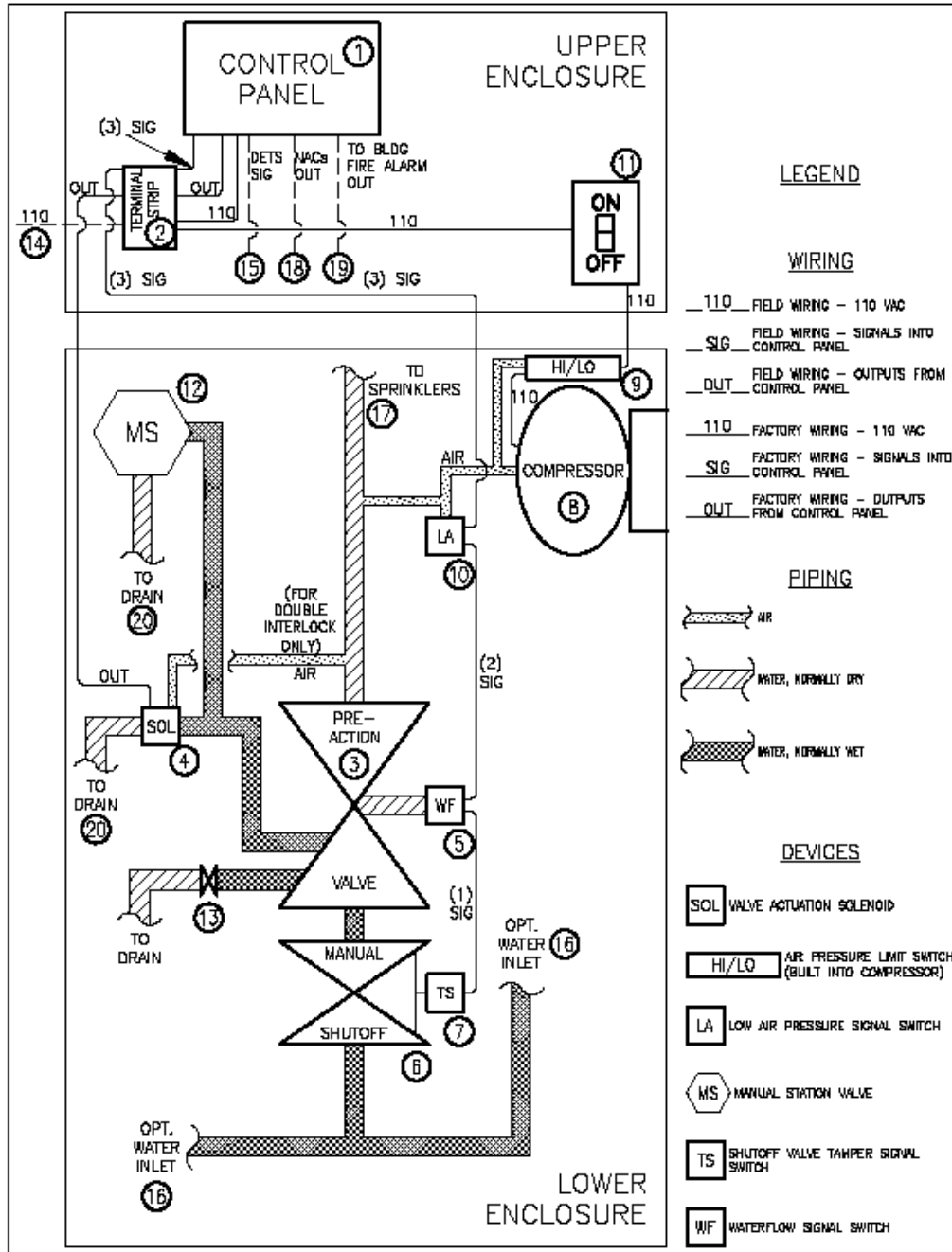

Figure 3 – Diagram - Functional Description

1.3. Functional Description. Refer to Figure 3 on page 4.

- 1.3.1. Control panel (1).** The control panel receives signals from fire detectors located in the protected space, as well as signals from various switches within the assembly. The panel processes the input signals per a pre-determined sequence of operation, and operates outputs for external audible / visual devices and building fire alarm signaling, as well as the signal to open the pre-action valve within the assembly. Refer to the control panel instruction manual in Section 4 for details on the panel and the sequence of operation.
- 1.3.2. Terminal strip (2).** The terminal strip provides a convenient point for landing some of the required field wiring, and also serves as the interface point between the control panel (1) and the various connections in the lower enclosure.
- 1.3.3. Pre-action valve (3).** The pre-action valve is the heart of the assembly. The valve holds back the sprinkler water until the control panel (1) reacts to the signal from the fire detectors and sends a signal to the valve actuation solenoid (4). In single-interlock assemblies, actuation of the valve actuation solenoid (4) sends water into the sprinkler pipe. In double-interlock assemblies, fusing of a sprinkler head from heat is required, along with valve actuation solenoid (4) actuation, to send water into the sprinkler pipe. Refer to Manual I-769P in Section 2 for more detailed information on the pre-action valve.
- 1.3.4. Valve actuation solenoid (4).** The valve actuation solenoid receives the signal from the control panel (1), and actuates the pre-action valve (3). The solenoid is the Victaulic Series 753-E, and is rated at 24VDC, 0.364 amps, 8.7 watts, 66 ohms. The solenoid is FM Approved under Group I (as in India). Refer to Manual I-769P in Section 2 for more detailed information.
- 1.3.5. Waterflow signal switch (5).** The waterflow signal switch responds to waterflow in the pipe downstream of the pre-action valve (3). The switch contains Quantity 2, SPDT switches, rated at 10A-125/250VAC, 1/2HP, 2.5A-6/12/24VDC. Contacts transfer when waterflow begins after pre-action valve opens. Contacts automatically restore when waterflow ceases. One contact is factory-wired to send a signal to the control panel (1). Refer to the control panel instruction manual in Section 4 for details on the response of the panel to the waterflow signal switch.
- 1.3.6. Manual shutoff valve (6).** The manual shutoff valve is used to shut off the flow of water after actuation of the pre-action valve (3). The normal position of this valve when the system is in service is open. Refer to Manual I-769P in Section 2 for more detailed information on the use of this valve.
- 1.3.7. Shutoff valve tamper signal switch (7).** The shutoff valve tamper signal switch sends a supervisory signal to the control panel (1) when the manual shutoff valve (6) is closed. The switch contains Quantity 2, SPDT switches, rated at 10A-125/250VAC, 0.5A-125VDC. Contacts transfer when valve begins to close. Contacts restore when valve is fully open. One contact is factory-wired to send a signal to the control panel (1). Refer to the control panel instruction manual in Section 4 for details on the response of the panel to the shutoff valve tamper signal switch.
- 1.3.8. Compressor (8).** The compressor supplies supervisory air pressure to fill the sprinkler pipe downstream of the pre-action valve (3). The sprinkler pipe is pressurized to 13 PSIG minimum and 18 PSIG maximum by the compressor (8). Loss of this pressure, from damage to the pipe or a sprinkler head, results in a supervisory signal at the control panel (1).
- 1.3.9. High / low air pressure limit switch (9).** The high / low air pressure limit switch is built in to the compressor (8). When pressure in the pipe falls below 13 PSIG, the switch turns the compressor (8) on. When pressure in the pipe rises to 18 PSIG, the switch turns the compressor (8) off.
- 1.3.10. Low air pressure signal switch (10).** The low air pressure signal switch sends the supervisory signal for low air pressure to the control panel (1). The switch contains Quantity 2, SPDT switches, rated at 10A-125/250VAC, 1/2HP, 2.5A-6/12/24VDC. Contacts transfer when pressure in the piping falls below 13PSIG. Contacts automatically restore when pressure rises above 13PSIG. One contact is factory-wired to send a signal to the control panel (1). Refer to the control panel instruction manual in Section 4 for details on the response of the panel to the low air pressure signal switch.
- 1.3.11. Compressor disconnect switch (11).** The compressor disconnect switch is used to manually interrupt the 110VAC power to the compressor motor, during inspection, maintenance, and

resetting of the assembly. Only trained personnel should use this switch. The normal position of this switch when the system is in service is ON.

- 1.3.12. Manual station valve (12).** The manual station valve is located behind a separate door on the front of the lower enclosure. No key is needed to open this door. To manually open the pre-action valve (3), open the door and pull the lever on the manual station valve forward. The pre-action valve (3) will open, and the sprinkler pipe will fill with water. No power is needed to manually open the pre-action valve (3) in this manner.



IMPORTANT

Fusing of a sprinkler head by heat is necessary for water to be discharged onto a fire, even after operation of the manual station valve.

- 1.3.13. Drain valve (13).** The drain valve is used to drain the sprinkler pipe after actuation of the pre-action valve (3). This valve is used only during inspection, maintenance, and resetting of the assembly. Only trained personnel should use this valve. Refer to Manual I-769P in Section 2 for more detailed information on this valve. The normal position of this valve is closed.

- 1.3.14. Input connection for 110 VAC power (14).** 110VAC is required to power the assembly. This power shall come from a source in compliance with all applicable codes and standards. Internal wiring (factory assembled) takes this power to the control panel (1) and the compressor (8). If local codes require individual 110VAC power sources for the control panel (1) and the compressor (8), jumpers may be removed from the terminal strip (2) permitting this. Refer to Section 1.10 for additional information on this connection.

- 1.3.15. Input connection for automatic fire detectors (15).** Automatic fire detectors are required to provide the signal for opening the pre-action valve (3). These detectors are field-connected to this connection. See Section 1.10, and refer to the control panel instruction manual in Section 4 for details on these detectors and this connection.



IMPORTANT

Fusing of a sprinkler head by heat is necessary for water to be discharged onto a fire, even after operation of automatic fire detectors.

- 1.3.16. Water inlet connection (16).** The sprinkler water supply is field-connected to this connection. One of three optional water inlet connections may be chosen. The first is at the upper right corner of the lower enclosure. Use this connection if it is desired to bring the pipe to the assembly from above. (NOTE: Assemblies equipped with 1/2HP compressors do not have upper right corner inlet connection.) If it is desired to bring the pipe to the assembly from a location close to the floor, the connection may be made on the lower left of the assembly, or by disconnecting the top inlet piping, the connection may be made on the lower right of the assembly. Refer to Section 1.10 and Manual I-769P in Section 2 for more detailed information on this connection.

- 1.3.17. Outlet connection to fire sprinklers (17).** The outlet connection from the assembly to the fire sprinklers is field-connected to this connection. The connection is located in the top center of the lower enclosure, behind the upper enclosure. Refer to Section 1.10 and Manual I-769P in Section 2 for more detailed information on this connection.

1.3.18. Notification appliance output connection (18). Notification appliances are required by code to alert occupants that a fire has been detected. These appliances are field-connected to this connection. Refer to the control panel instruction manual in Section 4 for details on this connection.

1.3.19. Output connection to building fire alarm system (19). Most codes require a fire protection sub-system to signal the building fire alarm system. This signal is field-connected to this connection. Refer to the control panel instruction manual in Section 4 for details on this connection.

1.3.20. Drain connection (20). Drain water from the assembly must be piped away to a drain. The drain piping may be connected to the assembly on the left or the right side. Refer to Section 1.10 and Section 2 – Victaulic manual I-769P for more detailed information on this connection.

1.4. Configurations. United Fire Protection PREACTION-PAC sprinkler valve assemblies are available in the following configurations:

1.4.1. Valve sizes: 1-1/2" through 4".

1.4.2. Valve types: Single-interlock and double-interlock available in all valve sizes.

1.4.3. Compressor sizes:

1.4.3.1. For 1-1/2" and 2" valves: 1/6HP compressor only.

1.4.3.2. For 2-1/2" valves: 1/6HP and 1/3HP compressors available.

1.4.3.3. For 3" and 4" valves: 1/6HP, 1/3HP, and 1/2HP compressors available.

1.4.3.4. Compressors are capable of pressurizing piping systems up to the following limits:

1.4.3.4.1. 1/6HP compressor: maximum system capacity is 290 gallons.

1.4.3.4.2. 1/3HP compressor: maximum system capacity is 475 gallons.

1.4.3.4.3. 1/2HP compressor: maximum system capacity is 780 gallons.

1.4.4. Control panel: A Notifier RP-2001 conventional detection control panel is factory-installed in the upper enclosure.

1.5. Options. None at this time.

1.6. Approvals. United Fire Protection PREACTION-PAC sprinkler valve assemblies, as listed in this Manual, are Approved by FM Approvals under the heading "Automatic Water Control Valves." See pages 11 and 12 for Approved assemblies. NOTE: Although most PREACTION-PAC assemblies are FM Approved, custom-built units are supplied from time to time upon request. Various components within these custom assemblies maintain their individual approvals, but these custom assemblies are not FM Approved as a unit.

1.7. Applicable Standards. United Fire Protection PREACTION-PAC sprinkler valve assemblies are to be installed and maintained by qualified, trained personnel in accordance with:

1.7.1. National Fire Protection Association No. 13, "Standard for the Installation of Sprinkler Systems."

1.7.2. National Fire Protection Association No. 25, "Standard for the Inspection, Testing, and Maintenance of Water-Based Fire Protection Systems."

1.7.3. National Fire Protection Association No. 70, "National Electrical Code®".

1.7.4. National Fire Protection Association No. 72, "National Fire Alarm Code®."

1.8. Applicable Manuals. Manuals supplied by the manufacturers of components used in United Fire Protection PREACTION-PAC assemblies are included with this manual. In some cases, these manuals contain references that are **NOT APPLICABLE** to PREACTION-PAC assemblies. The following tables detail these NOT APPLICABLE items. Care should be taken to be clear on what is applicable and what is not when referring to these manuals for installation, operation, inspection, and maintenance instructions.

PREACTION-PAC
with NOTIFIER RP-2001 RELEASING CONTROL PANEL
INSTALLATION, OPERATION, AND MAINTENANCE MANUAL
P/N 10-500001-00C
VERSION 1.1 – JULY 2011

Table 1.8.1 – Items Applicable and Not Applicable in Section 2 – Victaulic Manual
I769P – Firelock NXT Preaction Valve

Page No.	X Indicates Page IS Applicable	X Indicates Page IS NOT Applicable	Notes
Title	X		
Blank		X	
1 - 2	X		
3	X		Applicable valve sizes are 1-1/2" through 4".
4 - 6		X	
7	X		Item 10 – Series 760 Water Motor Alarm is NOT applicable.
8	X		
9	X		Series 776 Low Pressure Actuator is applicable to Double Interlock only.
10		X	
11	X		Series 757 Regulated AMTA is NOT applicable.
12	X		Series 757P Regulated AMTA is NOT applicable.
13	X		It is NOT necessary to remove foam spacer from valve – operation performed at UFP factory.
14	X		Compression fittings and tubes installed at UFP factory.
15	X		Series 746-LPA Dry Accelerator NOT installed.
16 - 17	X		1. Series 776 Low Pressure Actuator is applicable to Double Interlock only. 2. Step 11 – Ball valves on AMTA are NOT applicable.
18 - 19	X		Series 746-LPA Dry Accelerator is NOT applicable.
20 - 21	X		AMTA and Dry Accelerator ball valves are NOT applicable.
22	X		
23	X		AMTA and Dry Accelerator ball valves are NOT applicable.
24	X		
25	X		Series 746-LPA Dry Accelerator is NOT applicable.
26	X		AMTA ball valves are NOT applicable.
27 - 28	X		AMTA and Dry Accelerator ball valves are NOT applicable.
29 - 33	X		
34	X		AMTA ball valves are NOT applicable.
35 - 37	X		
38	X		Applicable valve sizes are 1-1/2" through 4".
39	X		
40	X		Applicable valve sizes are 1-1/2" through 4".
41	X		
42	X		Series 776 Low Pressure Actuator is applicable to Double Interlock only.
43	X		1. Series 776 Low Pressure Actuator is applicable to Double Interlock only. 2. Series 746-LPA Dry Accelerator is NOT applicable.
44	X		AMTA is not applicable.

PREACTION-PAC
with NOTIFIER RP-2001 RELEASING CONTROL PANEL
INSTALLATION, OPERATION, AND MAINTENANCE MANUAL
P/N 10-500001-00C
VERSION 1.1 – JULY 2011

Table 1.8.2 – Items Applicable and Not Applicable in Section 3 – General Air Products
Manual OILLESSINST – Compressor

Page No.	X Indicates Page IS Applicable	X Indicates Page IS NOT Applicable	Notes
1	X		<ol style="list-style-type: none"> 1. For assistance, please contact United Fire Protection. 2. The sections on “Receiving” and “Mounting” are not applicable, since the compressor has been unpacked, mounted in the assembly, and tested by UFP.
2	X		<ol style="list-style-type: none"> 1. The AMD-1 is not applicable. 2. Applicable units are OL11016, OL21533, and OL33550. All other units are not applicable.
3	X		<ol style="list-style-type: none"> 1. Applicable pressure switch setting is 13 PSIG cut-in and 18 PSIG cut-out. 2. Compressors used by UFP are single-phase models. Three-phase information is not applicable. 3. Warranty is supplied by United Fire Protection Corporation. Warranty information on this page is not applicable.
4	X		For excessive noise in operation, contact United Fire Protection. General Air Products contact note is not applicable.
5 - 6		X	
7	X		Figure 1 is applicable. Figure 2 is not applicable.
8		X	

PREACTION-PAC
with NOTIFIER RP-2001 RELEASING CONTROL PANEL
INSTALLATION, OPERATION, AND MAINTENANCE MANUAL
P/N 10-500001-00C
VERSION 1.1 – JULY 2011

Table 1.8.3.1 – Items Applicable and Not Applicable in Section 4 – Notifier Manual
52985 – RP-2001 Control Panel

Page No.	X Indicates Page IS Applicable	X Indicates Page IS NOT Applicable	Notes
Cover	X		
4-8	X		
9-16	X		Panel is contained within PREACTION-PAC upper enclosure – no need to install a cabinet.
17-19		X	Panel is contained within PREACTION-PAC upper enclosure – no need to install a cabinet.
20		X	Connect AC power to terminal strip in upper enclosure per Section 1.10.
21-22	X		Inputs from supervisory switches wired by UFP.
23	X		Solenoid output for pre-action valve wired by UFP.
24	X		
25	X		Follow the guidelines on this page for wire routing, keeping in mind that the panel is installed in the PREACTION-PAC upper enclosure, not the OEM enclosure.
26-45	X		
46-83	X		The control panel is factory-programmed by UFP with a basic pre-action system program. When changes are necessary to suit field conditions, follow the instructions on these pages. NOTE: Cross-zoned systems connected for pre-action release are not accepted in New York City, NY.
84-97	X		
98-100	X		
101	X		Upper enclosure is capable of containing batteries up to 26 A-H capacity.
102-107	X		Cross-zoned systems connected for pre-action release are not accepted in New York City, NY.
108-122			The control panel is factory-programmed by UFP with a basic pre-action system program. When changes are necessary to suit field conditions, follow the instructions on these pages. NOTE: Cross-zoned systems connected for pre-action release are not accepted in New York City, NY.
123-130	X		
131-132	X		
133-134	X		
135-142	X		
Last Page		X	Warranty is supplied by United Fire Protection Corporation. Warranty information on this page is not applicable.

1.9 FM Approved Assemblies

Part Number Coding:

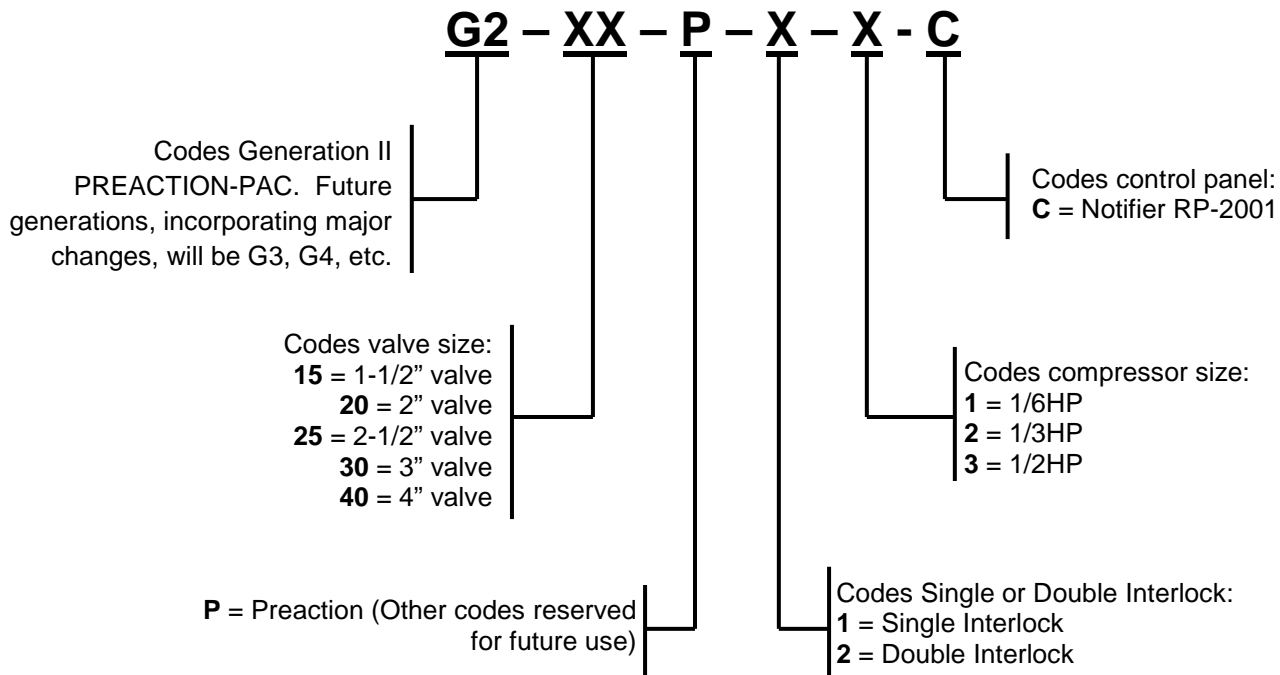

PREACTION-PAC assemblies with indicated part numbers are FM Approved. From time to time, custom-built units are supplied upon request. The components in these custom-built units retain their individual approvals, but these custom-built units are not FM Approved.

When the Preaction-Pac is installed where FM Global is an AHJ, follow the requirements of FM Approvals Class Numbers 1011, 1012, 1013 and FM Global Property Loss Prevention Data Sheet 5-40 dated 2007, especially:

- Alarm control panels for automatic release of preaction sprinkler systems are required to have 90 hours of secondary power followed by 10 minutes of release power and alarm operation.
- Include the installation of Class A (Style D or E) initiating device circuits. All FM Approved systems / installations must be configured as Class A for Deluge and Preaction Releasing Service.
- Do not include abort switches to abort the preaction sprinkler actuation function.

PREACTION-PAC
with NOTIFIER RP-2001 RELEASING CONTROL PANEL
INSTALLATION, OPERATION, AND MAINTENANCE MANUAL
P/N 10-500001-00C
VERSION 1.1 – JULY 2011

Table 1.9.1 – Approved PREACTION-PAC Assemblies with Notifier RP-2001 Control Panel

Part Number	Valve Size, in.	Valve Type	Compressor Size, HP	Control Panel
G215P11C	1-1/2"	Single Interlock	1/6	Notifier RP-2001
G215P21C	1-1/2"	Double Interlock	1/6	Notifier RP-2001
G220P11C	2"	Single Interlock	1/6	Notifier RP-2001
G220P21C	2"	Double Interlock	1/6	Notifier RP-2001
G225P11C	2-1/2"	Single Interlock	1/6	Notifier RP-2001
G225P12C	2-1/2"	Single Interlock	1/3	Notifier RP-2001
G225P21C	2-1/2"	Double Interlock	1/6	Notifier RP-2001
G225P22C	2-1/2"	Double Interlock	1/3	Notifier RP-2001
G230P11C	3"	Single Interlock	1/6	Notifier RP-2001
G230P12C	3"	Single Interlock	1/3	Notifier RP-2001
G230P13C	3"	Single Interlock	1/2	Notifier RP-2001
G230P21C	3"	Double Interlock	1/6	Notifier RP-2001
G230P22C	3"	Double Interlock	1/3	Notifier RP-2001
G230P23C	3"	Double Interlock	1/2	Notifier RP-2001
G240P11C	4"	Single Interlock	1/6	Notifier RP-2001
G240P12C	4"	Single Interlock	1/3	Notifier RP-2001
G240P13C	4"	Single Interlock	1/2	Notifier RP-2001
G240P21C	4"	Double Interlock	1/6	Notifier RP-2001
G240P22C	4"	Double Interlock	1/3	Notifier RP-2001
G240P23C	4"	Double Interlock	1/2	Notifier RP-2001

PREACTION-PAC
with NOTIFIER RP-2001 RELEASING CONTROL PANEL
INSTALLATION, OPERATION, AND MAINTENANCE MANUAL
P/N 10-500001-00C
VERSION 1.1 – JULY 2011

1.10. Installation.

1.10.1. Location. Locate the PREACTION-PAC assembly as shown on the system shop drawings or design plans. The location should be dry, clean, and within the Approved temperature range of the assembly (+40 deg F to +110 deg F). Refer to Figure 4 for overall dimensions.

1.10.2. Unpacking, Placement & Leveling. Unpack the PREACTION-PAC as follows:

1.10.2.1. Remove the outer carton and any other packing material surrounding the assembly.

1.10.2.2. Open the lower enclosure door.

1.10.2.3. Use a flat-bladed or Phillips screwdriver to remove the (4) bolts holding the assembly to the pallet. See Figure 5.

1.10.2.4. Close the lower enclosure door. Remove the unit from the pallet, and place in the intended installation location.

1.10.2.5. Level the unit:

1.10.2.5.1. Open the lower enclosure door.

1.10.2.5.2. Using a flat-bladed screwdriver, adjust the (4) leveling feet from inside the enclosure until all feet are firmly in contact with the floor. See Figure 5.

1.10.2.5.3. Using a spirit level, adjust the leveling feet until the assembly is level both front-to-back and side-to-side.

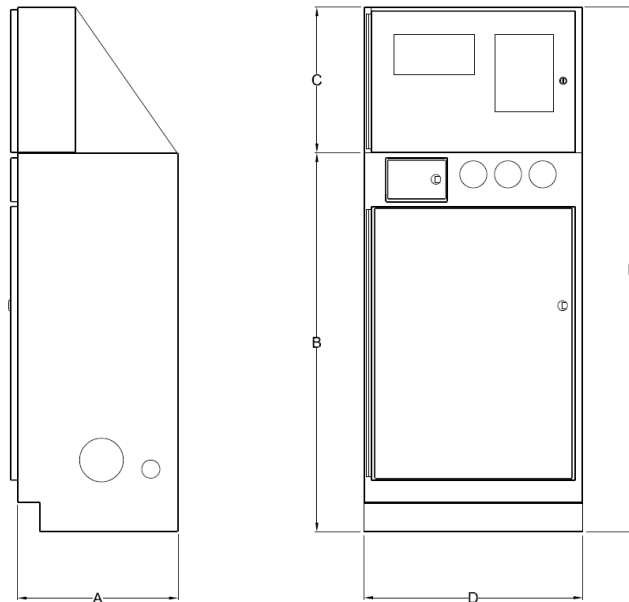

Dimension	Assemblies with 1-1/2" thru 3" Pre-Action Valves	Assemblies with 4" Pre-Action Valves
A	22.00	24.00
B	52.00	52.00
C	20.00	20.00
D	30.00	30.00
E	72.00	72.00

NOTE: All units are in inches.

Figure 4 – Diagram - Overall Dimensions

PREACTION-PAC
with NOTIFIER RP-2001 RELEASING CONTROL PANEL
INSTALLATION, OPERATION, AND MAINTENANCE MANUAL
P/N 10-500001-00C
VERSION 1.1 – JULY 2011

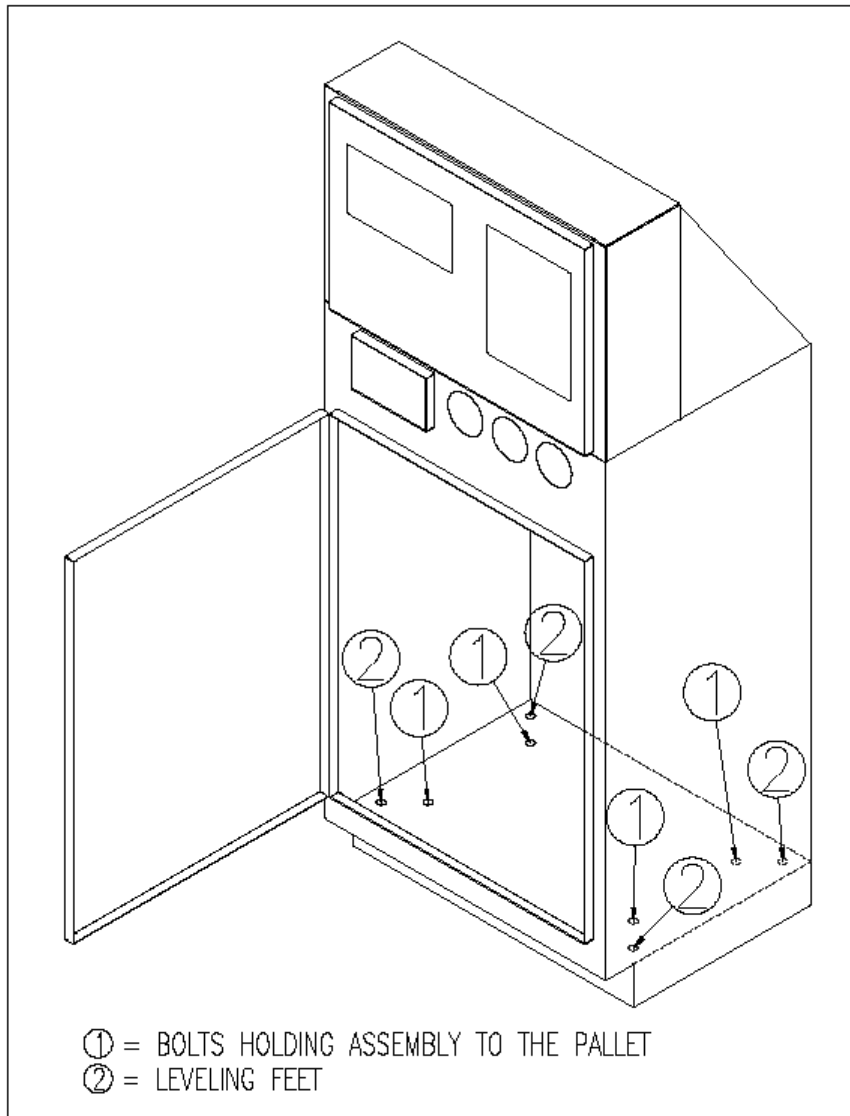
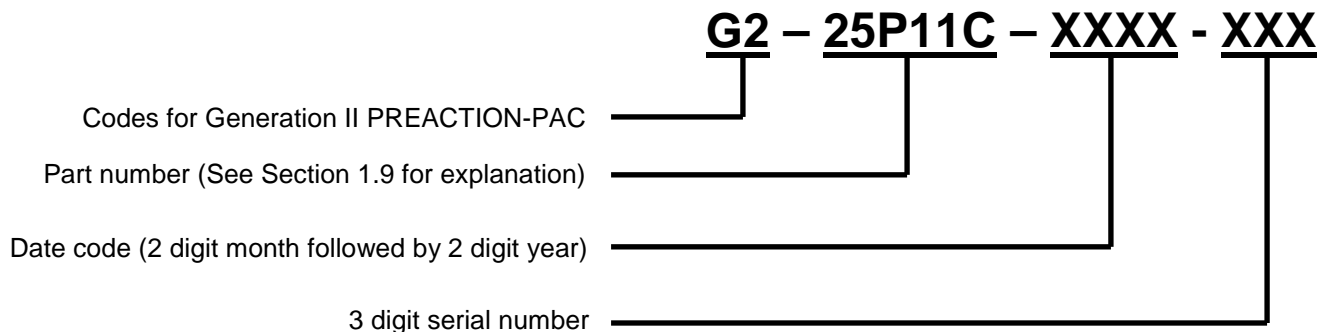

Figure 5 – Diagram - Location of Pallet Bolts and Leveling Feet

1.10.3. Serial Number. The serial number of each assembly is located on a permanent metal nameplate, located behind the upper enclosure door above the compressor disconnect switch. The serial number is coded as follows:



Note the serial number, date of installation, and date of commissioning on the front of this manual where indicated.

1.10.4. External Attachments.

1.10.4.1. Pre-Action Valve. Use Section 2 - Victaulic manual I-769P to guide the installation of inlet, outlet, and drain piping. See Figure 6 for details.

1.10.4.1.1. Inlet Piping. Inlet piping may be attached to the PREACTION-PAC in one of three locations:

- The standard connection is at the upper right corner of the lower enclosure. The assembly is pre-piped to accept inlet piping at this location. This location is labeled INLET. (NOTE: Assemblies equipped with 1/2HP compressors do not have upper right corner inlet connection. Use either lower left center or lower right center connection as described below.) Remove the plastic protection cap from the inlet pipe, and use a field-supplied grooved coupling to make this connection.
- An optional connection at the lower left center of the lower enclosure. Remove the pre-cut knockout from the lower left center of the lower enclosure. Remove the steel cap from the grooved coupling on the left side of the tee at the bottom of the enclosure. Attach the inlet piping to the left side of the tee using the grooved coupling. Remove the plastic protection cap from the top inlet connection, and assemble the steel cap removed from the tee to the top inlet connection using a field-supplied grooved coupling.



Failure to assemble the steel cap to the top inlet will result in property damage due to water escaping from the top inlet.

- An optional connection at the lower right center of the lower enclosure. Remove the pre-cut knockout from the lower right center of the lower enclosure. Remove the two grooved couplings from the elbow attached to the right side of the tee. (The elbow and one coupling may be discarded.) Attach the inlet piping to the right side of the tee using one of the grooved couplings. DO NOT attempt to remove any of the rest of the top inlet piping.

1.10.4.1.2. Outlet Piping. Outlet piping is attached to the PREACTION-PAC in one location; at the top center of the lower enclosure. This location is labeled OUTLET. Remove the plastic protection cap from the outlet pipe, and use a field-supplied grooved coupling to make this connection.

PREACTION-PAC
with NOTIFIER RP-2001 RELEASING CONTROL PANEL
INSTALLATION, OPERATION, AND MAINTENANCE MANUAL
P/N 10-500001-00C
VERSION 1.1 – JULY 2011

1.10.4.1.3. Drain Piping. Drain piping is attached to the PREACTION-PAC at a nipple located in the lower enclosure. The drain pipe may exit the enclosure on either the left or right side. Remove the precut knockout from the chosen side. Attach the drain pipe to the nipple with two field-supplied grooved couplings and a field-supplied grooved elbow.

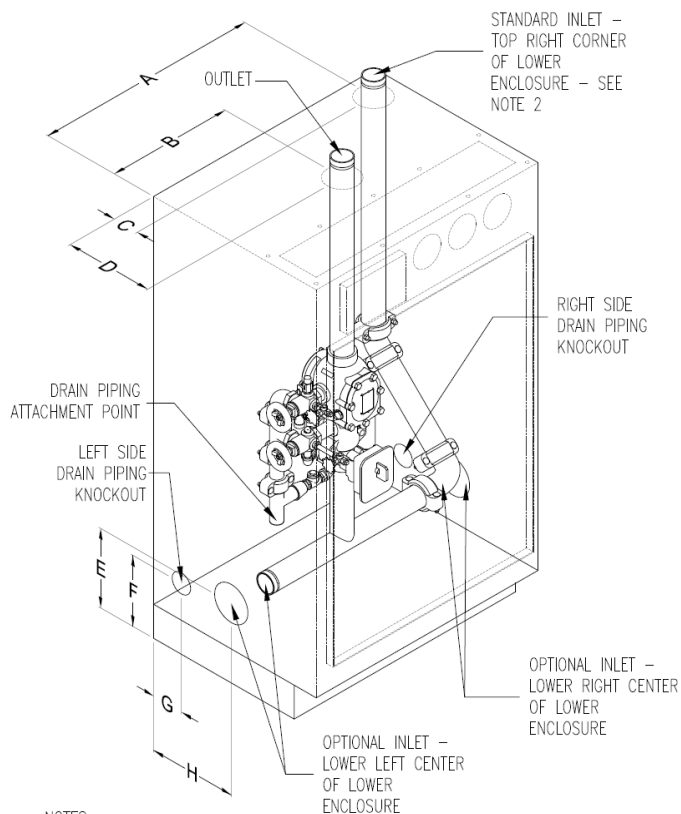

- NOTES:
1. TRIM ELEMENTS AND UPPER ENCLOSURE REMOVED FOR CLARITY
2. ASSEMBLIES EQUIPPED WITH 1/2HP COMPRESSORS DO NOT HAVE TOP INLET CONNECTION

Dimension	Assemblies with 1-1/2" thru 3" Pre-Action Valves	Assemblies with 4" Pre-Action Valves
A	26.64	26.14
B	15.00	15.00
C	3.11	3.61
D	10.50	12.50
E	9.36	9.86
F	8.36	8.86
G	3.75	5.75
H	10.50	12.50

NOTE: All units are in inches.

Figure 6 – Diagram - Piping Attachment

1.10.4.2. Terminal Strip and Control Panel. See Figure 7 for information on connection to the terminal strip in the upper enclosure. Use Section 4 – Notifier manual 52985 to guide the installation of connections to the control panel. Terminals for 110VAC power accept qty. (1) 10 ga. max. conductor. NOTE: All conductors used for field wiring must comply with NFPA 70 – National Electrical Code, and control panel manufacturer's instructions (see Section 4). See Section 4, page 25 for information on power-limited conductor runs.



DO NOT drill or punch the upper enclosure to attach conduit. Use the knockouts supplied at the lower back of the upper enclosure. Failure to follow these instructions can result in damage to the control panel. United Fire Protection Corporation will not be responsible for warranty adjustment of damaged control panels when these instructions are not followed.



This assembly contains static-sensitive components. ALWAYS ground yourself with a proper wrist strap before handling any electronic components or circuits. Failure to do so can lead to equipment damage from static electricity.

PREACTION-PAC
with NOTIFIER RP-2001 RELEASING CONTROL PANEL
INSTALLATION, OPERATION, AND MAINTENANCE MANUAL
P/N 10-500001-00C
VERSION 1.1 – JULY 2011

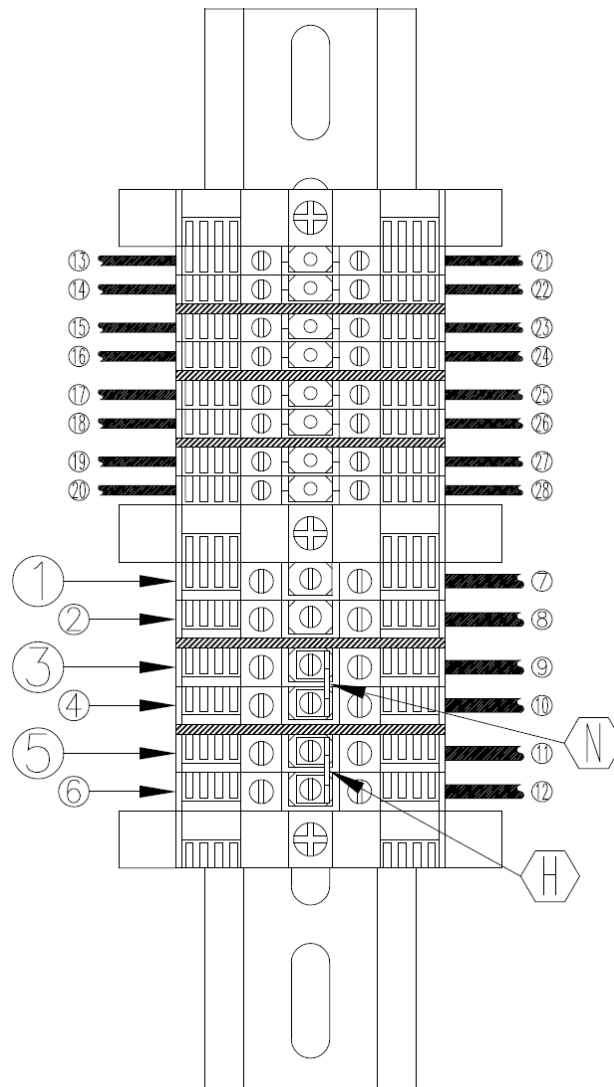

Figure 7 – Diagram - Terminal Strip Wiring Detail

PREACTION-PAC
with NOTIFIER RP-2001 RELEASING CONTROL PANEL
INSTALLATION, OPERATION, AND MAINTENANCE MANUAL
P/N 10-500001-00C
VERSION 1.1 – JULY 2011

LEGEND		
FIELD WIRING		
	NO JUMPER USED	COLOR OF TERMINAL BLOCK
1	DEDICATED 110 VAC GROUND FOR CONTROL PANEL (COMPRESSOR WILL ALSO BE GROUNDED THROUGH THIS TERMINAL)	GREEN/YELLOW
2	DEDICATED 110 VAC GROUND FOR AIR COMPRESSOR (USE ONLY IF REQUIRED BY AHJ)	GREEN/YELLOW
	WITH JUMPER (N) IN PLACE	WITH JUMPER (N) REMOVED
3	110 VAC NEUTRAL FOR CONTROL PANEL AND COMPRESSOR	110 VAC NEUTRAL FOR CONTROL PANEL ONLY
4	DO NOT USE	110 VAC NEUTRAL FOR COMPRESSOR ONLY
	WITH JUMPER (H) IN PLACE	WITH JUMPER (H) REMOVED
5	110 VAC HOT FOR CONTROL PANEL AND COMPRESSOR	110 VAC HOT FOR CONTROL PANEL ONLY
6	DO NOT USE	110 VAC HOT FOR COMPRESSOR ONLY
FACTORY WIRING		
7	110 VAC GROUND TO CONTROL PANEL	GREEN/YELLOW
8	110 VAC GROUND TO AIR COMPRESSOR	GREEN/YELLOW
9	110 VAC NEUTRAL TO CONTROL PANEL	WHITE
10	110 VAC NEUTRAL TO AIR COMPRESSOR	WHITE
11	110 VAC HOT TO CONTROL PANEL	BLACK
12	110 VAC HOT TO AIR COMPRESSOR	BLACK
13	PREACTION SOLENOID WIRING (-) FROM LOWER ENCLOSURE	GRAY
14	PREACTION SOLENOID WIRING (+) FROM LOWER ENCLOSURE	RED
15	LOW AIR SIGNAL SWITCH WIRING (NO) FROM LOWER ENCLOSURE	GRAY
16	LOW AIR SIGNAL SWITCH WIRING (COM) FROM LOWER ENCLOSURE	GRAY
17	WATERFLOW SIGNAL SWITCH WIRING (NO) FROM LOWER ENCLOSURE	BLUE
18	WATERFLOW SIGNAL SWITCH WIRING (COM) FROM LOWER ENCLOSURE	BLUE
19	TAMPER SIGNAL SWITCH WIRING (NO) FROM LOWER ENCLOSURE	YELLOW
20	TAMPER SIGNAL SWITCH WIRING (COM) FROM LOWER ENCLOSURE	YELLOW
21	PREACTION SOLENOID (-) TO CONTROL PANEL	GRAY
22	PREACTION SOLENOID (+) TO CONTROL PANEL	RED
23	LOW AIR SIGNAL SWITCH WIRING (NO) TO CONTROL PANEL	GRAY
24	LOW AIR SIGNAL SWITCH WIRING (COM) TO CONTROL PANEL	GRAY
25	WATERFLOW SIGNAL SWITCH WIRING (NO) TO CONTROL PANEL	BLUE
26	WATERFLOW SIGNAL SWITCH WIRING (COM) TO CONTROL PANEL	BLUE
27	TAMPER SIGNAL SWITCH WIRING (NO) TO CONTROL PANEL	YELLOW
28	TAMPER SIGNAL SWITCH WIRING (COM) TO CONTROL PANEL	YELLOW
JUMPERS		
(N)	CONNECTS CONTROL PANEL & COMPRESSOR 110 VAC NEUTRAL CONDUCTORS – REMOVE TO SEPARATE	
(H)	CONNECTS CONTROL PANEL & COMPRESSOR 110 VAC HOT CONDUCTORS – REMOVE TO SEPARATE	

Legend for Figure 7

1.10.4.3.1. Power. 110VAC, 3-wire, single-phase power is attached to the terminal strip in the upper enclosure. See Figure 7. Terminals for 110VAC power accept qty. (1) 10 ga. max. conductor. Current draw: With 1/6HP compressor = 11.3 amps; with 1/3HP compressor = 11.3 amps, with 1/2HP compressor = 12.7 amps.



Only qualified electricians should connect incoming power to the assembly. Failure to follow this instruction could result in death or serious personal injury.

- A. Turn off circuit breaker at the main power distribution panel.
- B. Connect service ground conductor to terminal marked GROUND.
- C. Connect primary neutral conductor to terminal marked NEUTRAL.
- D. Connect primary hot conductor to terminal marked HOT.

1.10.4.3.2. Backup Batteries. Calculate backup battery requirements, and connect backup batteries, per Section 4 – Notifier manual 52985. The upper enclosure is capable of holding batteries up to 26 A-H. If larger batteries are needed, use an external battery enclosure per Section 4 – Notifier manual 52985.

1.10.4.3.3. Fire Detectors (Initiating Devices). Fire detectors (initiating devices), located in the area protected by the sprinklers connected to the PREACTION-PAC, are necessary to provide the signal to open the pre-action valve. Refer to NFPA 72 for information on the number, type, and spacing of fire detectors. Install detectors, wiring, and panel connections per Section 4 – Notifier manual 52985. All FM Approved systems / installations must be configured as Class A for Deluge and Preaction Releasing Service. The Notifier CAC-5 Class A Module is factory-installed on the control panel.

1.10.4.3.4. Audible / Visual Appliances (Indicating Devices). Audible / visual appliances (indicating devices), located in and around the area protected by the sprinklers connected to the PREACTION-PAC, are necessary to warn occupants that a fire has been detected. Refer to NFPA 72 for information on the number, type, and spacing of audible / visual appliances. Install audible / visual devices, wiring, and panel connections per Section 4 – Notifier manual 52985.

1.10.4.3.5. Building Fire Alarm Systems. In buildings with fire alarm systems separate from the PREACTION-PAC detection system, most national and local codes and authorities having jurisdiction require the PREACTION-PAC to provide signals to the building fire alarm system. The Notifier control panel installed in the PREACTION-PAC contains dry contacts capable of providing the necessary signals. Install audible / visual devices, wiring, and panel connections per Section 4 – Notifier manual 52985.

1.10.4.3.6. Other Connections. From time to time, additional signals from the PREACTION-PAC control panel may be required. Such signals can be associated with building management systems, equipment shutdown, or security notification. Additional dry contacts may be needed to satisfy all of these requirements.

1.10.4.4. Compressor. See Figure 7. 110VAC, 3-wire, single-phase power is attached to the terminal strip in the upper enclosure. The compressor power is factory-wired to the terminal strip in the upper enclosure. In the default configuration, the same 110VAC source used for the control panel serves for the compressor. If the local authority having jurisdiction requires separate power sources for the control panel and the compressor, jumpers can be removed from the terminal strip. The compressor pressure outlet is factory-attached to the system piping within the lower enclosure.

1.10.5. Prior To Placing In Service. Before placing the PREACTION-PAC in service, perform the following steps. Ensure that all discrepancies are corrected before proceeding to the next step.

- 1.10.5.1.** Ensure the entire system is installed per the latest revision of all applicable shop drawings.
- 1.10.5.2.** Ensure all testing has been performed on the sprinkler piping per the requirements of the authority having jurisdiction and NFPA 13.
- 1.10.5.3.** Use Section 4 – Notifier manual 52985 to perform all preliminary tests on the control panel, field wiring, and field devices.
- 1.10.5.4.** Use Section 2 – Victaulic manual I-769P to perform all preliminary tests on the pre-action valve, trim, and sprinkler piping.
- 1.10.5.5.** Perform all tests required to be witnessed by the authority having jurisdiction. Obtain AHJ approval of the installation.

1.10.6. Placing In Service.

- 1.10.6.1.** Verify that the control panel is indicating POWER ON, with no alarm or trouble indicators illuminated, and no error messages on the display.
- 1.10.6.2.** Verify that the water supply is on.
- 1.10.6.3.** Using Section 2 – Victaulic manual I-769P, verify that all valves are in the proper position for in-service status. Verify that the three pressure gages on the front of the lower enclosure are indicating expected values within expected limits.
- 1.10.6.4.** Ensure that the owner of the system has received adequate introductory training.
- 1.10.6.5.** Turn over this manual and the enclosure door keys to the owner. The manual may be stored in the pocket on the inside of the lower enclosure door.

1.11. Operation.

- 1.11.1. Automatic.** Fully automatic operation of the system will be conducted by the control panel. Power from 110VAC and / or batteries is required for the control panel to function in this way. No manual intervention is required for the control panel to perform its functions. Manual intervention to acknowledge and silence signals may be performed. Refer to Section 4 – Notifier manual 52985 for information on signals.



IMPORTANT

Fusing of a sprinkler head by heat is necessary for water to be discharged onto a fire, even after operation of automatic fire detectors.

- 1.11.2. Manual.** Manual operation of the pre-action valve is accomplished with the manual release valve. Open the door marked IN CASE OF FIRE OPEN DOOR AND PULL LEVER. No key is needed to open this door. Pull the lever. No power is needed to open the pre-action valve in this manner. The door may not be closed until the lever is restored to its normal position.



IMPORTANT

Fusing of a sprinkler head by heat is necessary for water to be discharged onto a fire, even after operation of the manual station valve.

1.11.3. Restoring To Service. After automatic or manual system operation, follow instructions in Section 2 – Victaulic manual I-769P and Section 4 – Notifier manual 52985 to restore the individual parts of the PREACTION-PAC to service.

1.12. Inspection, Testing, and Maintenance. Regular inspection, testing and maintenance of the PREACTION-PAC assembly is essential to the assembly's continued proper operation. Follow all instructions in the documents described in this section. Pay particular attention to the required minimum interval for each item of inspection, testing, and maintenance. The owner of the system (or their designated representative) is responsible for the overall condition of the system, and ensuring that all inspection, testing, and maintenance items are conducted as recommended.



IMPORTANT

The United Fire Protection PREACTION-PAC sprinkler valve assembly is a vital part of the fire protection of any facility where these units are installed. Life safety and property protection depends on continuing proper operation of the assembly. The owner of the PREACTION-PAC is responsible for the condition of the assembly and its continued proper operation. United Fire Protection strongly recommends that all owners of PREACTION-PACs engage the services of qualified, trained fire protection professionals to inspect, test, maintain, and repair the assembly.

1.12.1. Inspection. Inspection involves carrying out a set of procedures to discover and note any and all discrepancies that could render the system impaired, inoperative, or ineffective. The result of an inspection is a comprehensive list of these discrepancies. Inspection does not specifically include maintenance or repair; however, maintenance and repair can be and usually is conducted at the time of inspection.

1.12.2. Testing. Testing involves carrying out procedures to discover if tested components function as intended. Testing is an integral part of performing inspection. Testing is also done after the performance of some maintenance procedures.

1.12.3. Maintenance. Maintenance involves carrying out procedures to ensure that maintained components continue to function as intended. Maintenance is usually preventive in nature. Maintenance can be conducted during inspection.

1.12.4. Repair. Repair involves carrying out procedures to correct the deficiencies found during inspection, or as a result of other events such as system actuation or control panel trouble / alarm signals.

PREACTION-PAC
with NOTIFIER RP-2001 RELEASING CONTROL PANEL
INSTALLATION, OPERATION, AND MAINTENANCE MANUAL
P/N 10-500001-00C
VERSION 1.1 – JULY 2011

1.12.5. Documents Relevant To Inspection, Testing, Maintenance, and Repair.

1.12.5.1. Victaulic Manual I-769P.

1.12.5.2. General Air Products Manual OILLESSINST.

1.12.5.3. Notifier Manual 52985.

1.12.5.4. National Fire Protection Association No. 25, "Standard for the Inspection, Testing, and Maintenance of Water-Based Fire Protection Systems."

1.12.5.5. National Fire Protection Association No. 72, "National Fire Alarm Code®"

SECTION 2

Victaulic Manual I-769P

Firelock NXT Preaction
Valve

FireLock NXT™ Preaction Valve

SERIES 769

NON-INTERLOCKED, PNEUMATIC RELEASE WITH SERIES 776 LOW-PRESSURE ACTUATOR

NON-INTERLOCKED, PNEUMATIC/ELECTRIC RELEASE WITH SERIES 776 LOW-PRESSURE ACTUATOR AND SERIES 753-E SOLENOID VALVE

SINGLE-INTERLOCKED, PNEUMATIC RELEASE WITH SERIES 776 LOW-PRESSURE ACTUATOR

SINGLE-INTERLOCKED, ELECTRIC RELEASE WITH SERIES 753-E SOLENOID VALVE

DOUBLE-INTERLOCKED, ELECTRIC (ELECTRIC-PNEUMATIC/ELECTRIC) RELEASE WITH SERIES 753-E SOLENOID VALVE

HANG THESE INSTRUCTIONS ON THE INSTALLED VALVE FOR EASY FUTURE REFERENCE



WARNING



WARNING



- Failure to follow instructions and warnings can cause product failure, resulting in serious personal injury and property damage.
- Read and understand all instructions before attempting to install any Victaulic piping products.
- Wear safety glasses, hardhat, and foot protection.
- Save this installation, maintenance, and testing manual for future reference.

If you need additional copies of any literature, or if you have any questions concerning the safe installation and operation of this product, contact Victaulic, P.O. Box 31, Easton, PA 18044-0031, USA, Telephone: 1-800 PICK VIC, e-mail: pickvic@victaulic.com.

FireLock NXT™ Preaction Valve

SERIES 769

TABLE OF CONTENTS

Hazard Identification 1

Installer Safety Instructions 2

 General 2

 Maintenance and Testing 2

Introduction 3

Trim Dimensions 3

Exploded View Drawing – Trim Components 4

Exploded View Drawing – Trim Components 5

Exploded View Drawing – Trim Components 6

Exploded View Drawing – Trim Components 7

Exploded View Drawing – Internal Valve Components 8

Section View Drawing and Description –
Series 776 Low-Pressure Actuator 9

Section View Drawing and Description –
Series 746-LPA Dry Accelerator 10

Air Supply Requirements 11

 Compressor Sizing 11

 Base or Riser-Mounted Air Compressors 11

 Shop Air or Tank-Mounted Air Compressors 11

 Victaulic Series 757 Regulated Air Maintenance
 Trim Assembly (AMTA) Option 11

 Victaulic Series 757P Air Maintenance Trim Assembly
 (AMTA) with Pressure Switch Option 12

 Compressor Requirements and Settings for
 Series 769 FireLock NXT Preaction Valves
 Installed with Series 746-LPA Dry Accelerators 12

 Settings for Air Supervisory Pressure Switches
 and Alarm Pressure Switches 12

 Remote System Test Valve Requirements 12

Important Installation Information 13

Valve/Trim Installation 13

 Compression Fitting and Tube Installation 14

Hydrostatic Testing 14

Placing the System in Service 15

External Inspection 21

 Weekly Inspection 21

 Monthly Inspection 21

Required Tests 22

 Main Drain Test 22

 Water Flow Alarm Test 24

 Water Level and Low Air Alarm Tests 25

Required Operational (Trip) Tests 29

 Partial Operational (Trip) Test 29

 Full Operational (Trip) Test 31

Required Internal Inspection 33

Maintenance 36

 Removing and Replacing the Clapper Seal 36

 Removing and Replacing the Clapper Assembly 38

 Installing the Cover Plate Gasket and Cover Plate 40

 Removing and Replacing the Diaphragm Assembly 41

 Replacing the Strainer Screen for
 Series 776 Low-Pressure Actuators 42

Troubleshooting – Series 776 Low-Pressure Actuator 43

Troubleshooting – Series 753-E Solenoid Valve 43

Troubleshooting – Series 746-LPA Dry Accelerator 43

Troubleshooting – System 44

HAZARD IDENTIFICATION



Definitions for identifying the various hazard levels are provided below. When you see this symbol, be alert to the possibility of personal injury. Carefully read and fully understand the message that follows.

WARNING

- The use of the word “WARNING” identifies the presence of hazards or unsafe practices that could result in death or serious personal injury if instructions, including recommended precautions, are not followed.

CAUTION

- The use of the word “CAUTION” identifies possible hazards or unsafe practices that could result in personal injury and product or property damage if instructions, including recommended precautions, are not followed.



NOTICE

- The use of the word “NOTICE” identifies special instructions that are important but not related to hazards.

FireLock NXT™ Preaction Valve

SERIES 769

INSTALLER SAFETY INSTRUCTIONS

 WARNING	
	<ul style="list-style-type: none"> • An experienced, trained installer must install this product in accordance with all instructions. These instructions contain important information.
	<ul style="list-style-type: none"> • Depressurize and drain the piping system before attempting to install, remove, adjust, or maintain any Victaulic piping products. <p>Failure to follow these instructions can cause product failure, resulting in serious personal injury and/or property damage.</p>

GENERAL

1. **Read and understand all instructions and refer to the trim diagrams before proceeding with the installation, maintenance, and testing of this Victaulic Series 769 FireLock NXT Preaction Valve.**
2. **Inspect the shipment.** Make sure all components are included in the shipment and that all necessary tools are available for installation.
3. **Use only recommended accessories.** Accessories and equipment that are not approved for use with this valve may cause improper system operation.
4. **Wear safety glasses, hardhat, foot protection, and hearing protection.** Wear hearing protection if you are exposed to long periods of noisy job-site operations.
5. **Prevent back injury.** Larger and pre-trimmed valves are heavy and require more than one person or mechanical lifting equipment to position and install the assembly. Always practice proper lifting techniques.
6. **Avoid using electrically powered tools in dangerous environments.** When using electrically powered tools for installation, make sure the area is moisture-free. Keep the work area well lit, and allow enough space to accommodate proper installation of the valve, trim, and accessories.
7. **Watch for pinch points.** Do not place fingers under the valve body where they could be pinched by the weight of the valve. Use caution around spring-loaded components (i.e. clapper assembly).
8. **Keep work areas clean.** Cluttered areas, benches, and slippery floors can create hazardous working conditions.
9. **PROTECT THE SYSTEM FROM FREEZING CONDITIONS. THE VALVE AND SUPPLY PIPING MUST BE PROTECTED FROM FREEZING TEMPERATURES AND MECHANICAL DAMAGE.**
10. **IF THE INLET WATER SUPPLY IS INTERRUPTED FOR ANY REASON, AND SYSTEM SUPPLY PRESSURE TO THE VALVE DECREASES, MAKE SURE THE DIAPHRAGM CHARGE LINE IS FULLY PRESSURIZED BEFORE PLACING THE SYSTEM BACK IN SERVICE.**

MAINTENANCE AND TESTING

1. **Notify the authority having jurisdiction.** Always notify the authority having jurisdiction before performing any maintenance that eliminates the fire protection provided by the system.
2. **Follow NFPA requirements for system testing and inspection schedules.** The building owner or their representative is responsible for inspecting the system in accordance with current NFPA-25 requirements or in accordance with the requirements of the local authority having jurisdiction (whichever is more stringent).
3. **Depressurize and drain the system completely before performing any maintenance.** Water under pressure can cause the cover plate to blow off during removal if the system is not depressurized and drained completely.
4. **Protect the valve from freezing temperatures, foreign matter, and corrosive atmospheres.** Any condition that might degrade the system or affect system performance must be avoided.

FireLock NXT™ Preaction Valve

SERIES 769

INTRODUCTION

The following instructions are a guide for proper installation of Victaulic Series 769 FireLock NXT Preaction Valves. These instructions involve pipe that is properly prepared and grooved in accordance with current Victaulic specifications.

NOTICE

- Drawings and/or pictures in this manual may be exaggerated for clarity.
- This product and this installation, maintenance, and testing manual contain trademarks, copyrights, and/or patented features that are the exclusive property of Victaulic.

TRIM DIMENSIONS

THE 4-INCH/114.3-MM CONFIGURATION IS SHOWN BELOW. 1 ½ – 2-INCH/48.3 – 60.3-MM CONFIGURATIONS CONTAIN ¼-INCH/19-MM DRAIN VALVES. 2 ½ – 3-INCH/73.0 – 88.9-MM CONFIGURATIONS CONTAIN 1 ¼-INCH/31-MM DRAIN VALVES. 4 – 8-INCH/114.3 – 219.1-MM CONFIGURATIONS CONTAIN 2-INCH/50-MM DRAIN VALVES.

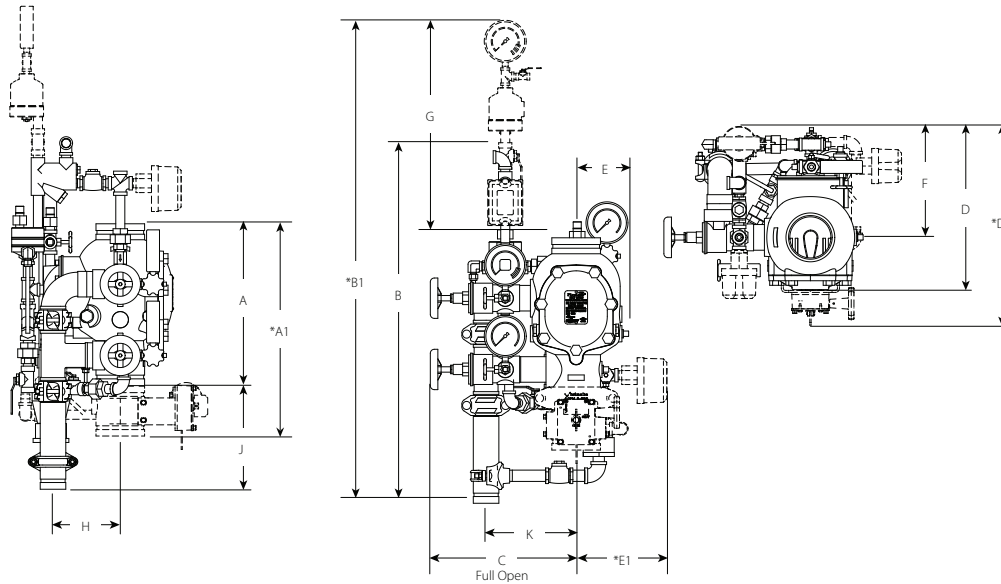

Size		Dimensions – inches/mm														Aprx. Weight Ea. lbs/kg	
Nominal Size inches	Actual Out. Dia. inches	A	A1*	B	B1*	C	D	D1*	E	E1*	F	G	H	J	K	Without Trim	With Trim
1½	1.900	9.00	16.43	28.25	40.50	13.75	16.00	—	5.25	8.50	9.50	22.25	3.04	9.17	6.98	16.7	43.0
40	48.3	228.60	417.32	717	1028	349	406	—	133	215	241	565	77.21	232.91	177.29	7.6	19.5
2	2.375	9.00	16.43	28.25	40.50	13.75	16.00	—	5.25	8.50	9.50	22.25	3.04	9.17	6.98	17.0	43.0
50	60.3	228.60	417.32	717	1028	349	406	—	133	215	241	565	77.21	232.91	177.29	7.7	19.5
2 ½	2.875	12.61	16.50	32.25	44.25	13.50	16.00	17.50	5.25	9.00	9.25	21.25	3.90	10.50	6.93	41.0	65.0
65	73.0	320.29	419.10	819	1123	342	406	444	133	228	234	539	99.06	266.70	176.02	18.7	29.5
76.1 mm	3.000	12.61	16.50	32.25	44.25	13.50	16.00	17.50	5.25	9.00	9.25	21.25	3.90	10.50	6.93	41.0	65.0
	76.1	320.29	419.10	819	1123	342	406	444	133	228	234	539	99.06	266.70	176.02	18.7	29.5
3	3.500	12.61	16.50	32.25	44.25	13.50	16.00	17.50	5.25	9.00	9.25	21.25	3.90	10.50	6.93	41.0	65.0
80	88.9	320.29	419.10	819	1123	342	406	444	133	228	234	539	99.06	266.70	176.02	18.7	29.5
4	4.500	15.03	19.78	33.25	45.50	15.00	15.75	20.50	5.50	9.00	10.75	20.75	6.25	9.62	8.46	59.0	95.0
100	114.3	381.76	502.41	844	1155	381	400	520	139	228	273	527	158.75	244.34	214.88	26.7	43.0
165.1 mm	6.500	16.00	22.00	33.50	45.75	15.50	17.00	22.00	6.00	8.50	11.50	20.00	6.20	9.62	8.84	80.0	116.0
	165.1	406.40	558.80	850	1162	393	431	558	152	215	292	508	157.48	244.34	224.53	36.2	52.6
6	6.625	16.00	22.00	33.50	45.75	15.50	17.00	22.00	6.00	8.50	11.50	20.00	6.20	9.62	8.84	80.0	116.0
150	168.3	406.40	558.80	850	1162	393	431	558	152	215	292	508	157.48	244.34	224.53	36.2	52.6
8	8.625	17.50	22.94	33.50	45.50	16.75	20.00	25.25	7.00	8.75	12.75	18.50	6.05	9.40	10.21	122.0	158.0
200	219.1	444.50	582.67	850	1155	425	508	641	177	222	323	469	153.67	238.76	259.33	55.3	71.6

NOTES:

The drawings shown above reflect the single-interlocked, pneumatic release trim with Series 776 Low-Pressure Actuator. In addition, these dimensions can be applied to single-interlocked, pneumatic release; non-interlocked, pneumatic/electric release; single-interlocked, electric release; and double-interlocked, electric (electric-pneumatic/electric) release trim.

The "A" dimension coupling is not shown for clarity.

Components shown as dotted lines denote optional equipment

* Measurements denoted with an asterisk take optional equipment into account

Optional drain connection kit is shown for reference and takeout dimensions.

FireLock NXT™ Preaction Valve

SERIES 769

EXPLODED VIEW DRAWING – TRIM COMPONENTS

SERIES 769 FIRELOCK NXT PREACTION VALVE – NON-INTERLOCKED, PNEUMATIC RELEASE TRIM (OPTIONAL ACCESSORIES ALSO SHOWN)



Bill of Materials

- 1 Series 769 FireLock NXT Preaction Valve
- 2 FireLock Rigid Coupling (Optional/Sold Separately – Comes Standard when VQR Assembly is Ordered)
- 3 Water Supply Main Control Valve (Optional/Sold Separately – Comes Standard when VQR Assembly is Ordered)
- 4 Drain Swing Check Valve
- 5 Drip Cup with Cap
- 6 Alarm Pressure Switch (Optional/Sold Separately – Comes Standard when VQR Assembly is Ordered)
- 7 Series 729 Drip Check Valve
- 8 Diaphragm-Charge-Line Ball Valve (Normally Open)
- 9 3-in-1 Strainer/Check/Restrictor Assembly
- 10 Series 760 Water Motor Alarm (Optional/Sold Separately)
- 11 Alarm Test Ball Valve
- 12 Diaphragm-Charge-Line Pressure Gauge (0-300 psi/0-2068 kPa/0-20.7 Bar)
- 13 Series 749 Auto Drain
- 14 Series 776 Low-Pressure Actuator
- 15 Air Manifold
- 16 Air Supervisory Pressure Switch (Optional/Sold Separately – Comes Standard when VQR Assembly is Ordered)
- 17 System Pressure Gauge (0-80 psi/0-552 kPa/0-5.5 Bar with Retard)
- 18 Water Supply Main Drain Valve - Flow Test
- 19 Water Supply Pressure Gauge (0-300 psi/0-2068 kPa/0-20.7 Bar)
- 20 Drain Connection Kit (Optional/Sold Separately – Comes Standard when VQR Assembly is Ordered)
- 21 Gauge Valve
- 22 System Main Drain Valve
- 23 Series 755 Manual Pull Station
- 24 Series 748 Ball Check Valve

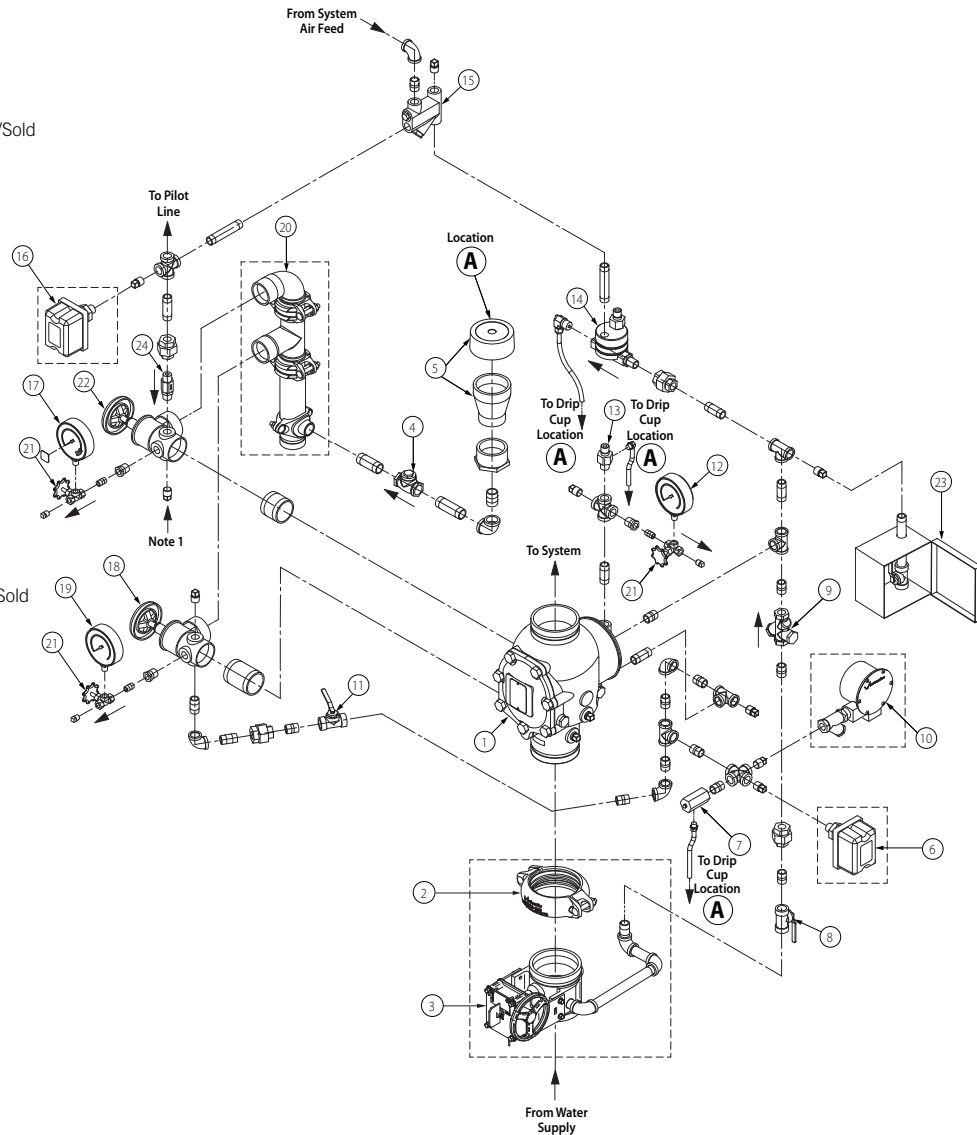

NOTE 1: Connection point for the Series 75D Water Column Device Kit

For information regarding installation of the Series 75B Supplemental Alarm Device or the Series 7C7 Air Maintenance/Compressor Assembly (not shown), refer to the instructions supplied with the product.

FireLock NXT™ Preaction Valve

SERIES 769

EXPLODED VIEW DRAWING – TRIM COMPONENTS

SERIES 769 FIRELOCK NXT PREACTION VALVE – NON-INTERLOCKED, PNEUMATIC/ELECTRIC RELEASE TRIM (OPTIONAL ACCESSORIES ALSO SHOWN)



Bill of Materials

- 1 Series 769 FireLock NXT Preaction Valve
- 2 FireLock Rigid Coupling (Optional/Sold Separately – Comes Standard when VQR Assembly is Ordered)
- 3 Water Supply Main Control Valve (Optional/Sold Separately – Comes Standard when VQR Assembly is Ordered)
- 4 Drain Swing Check Valve
- 5 Drip Cup with Cap
- 6 Alarm Pressure Switch (Optional/Sold Separately – Comes Standard when VQR Assembly is Ordered)
- 7 Series 729 Drip Check Valve
- 8 Diaphragm-Charge-Line Ball Valve (Normally Open)
- 9 3-in-1 Strainer/Check/Restrictor Assembly
- 10 Series 760 Water Motor Alarm (Optional/Sold Separately)
- 11 Alarm Test Ball Valve
- 12 Diaphragm-Charge-Line Pressure Gauge (0-300 psi/0-2068 kPa/0-20.7 Bar)
- 13 Series 749 Auto Drain
- 14 Series 776 Low-Pressure Actuator
- 15 Air Manifold
- 16 Air Supervisory Pressure Switch (Optional/Sold Separately – Comes Standard when VQR Assembly is Ordered)
- 17 System Pressure Gauge (0-80 psi/0-552 kPa/0-5.5 Bar with Retard)
- 18 Water Supply Main Drain Valve - Flow Test
- 19 Water Supply Pressure Gauge (0-300 psi/0-2068 kPa/0-20.7 Bar)
- 20 Drain Connection Kit (Optional/Sold Separately – Comes Standard when VQR Assembly is Ordered)
- 21 Gauge Valve
- 22 System Main Drain Valve
- 23 Series 755 Manual Pull Station
- 24 Series 748 Ball Check Valve
- 25 Series 753-E Solenoid Valve
- 26 Series 746-LPA Dry Accelerator (Optional/Sold Separately)

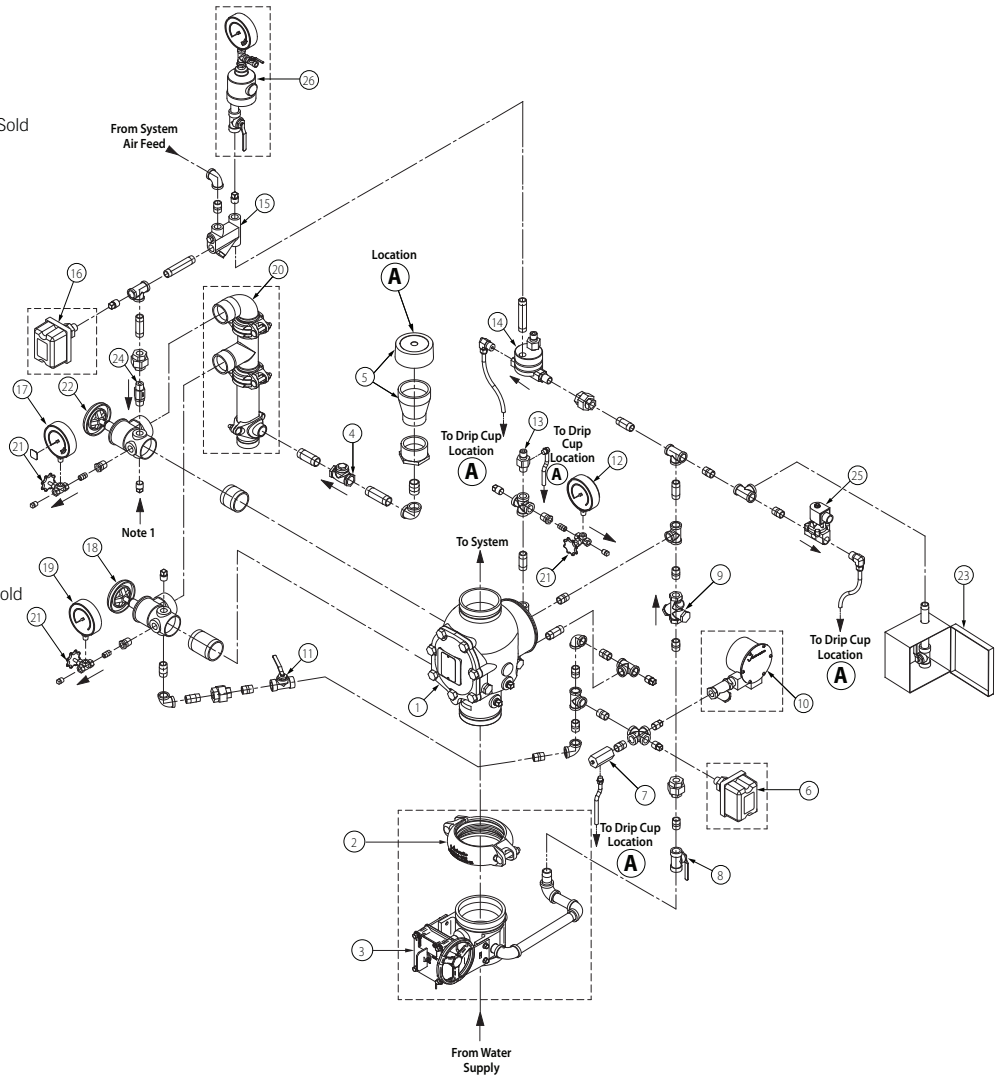

NOTE 1: Connection point for the Series 75D Water Column Device Kit

For information regarding installation of the Series 75B Supplemental Alarm Device or the Series 7C7 Air Maintenance/Compressor Assembly (not shown), refer to the instructions supplied with the product.

FireLock NXT™ Preaction Valve

SERIES 769

EXPLODED VIEW DRAWING – TRIM COMPONENTS

SERIES 769 FIRELOCK NXT PREACTION VALVE – SINGLE-INTERLOCKED, PNEUMATIC RELEASE TRIM (OPTIONAL ACCESSORIES ALSO SHOWN)



Bill of Materials

- 1 Series 769 FireLock NXT Preaction Valve
- 2 FireLock Rigid Coupling (Optional/Sold Separately – Comes Standard when VQR Assembly is Ordered)
- 3 Water Supply Main Control Valve (Optional/Sold Separately – Comes Standard when VQR Assembly is Ordered)
- 4 Drain Swing Check Valve
- 5 Drip Cup with Cap
- 6 Alarm Pressure Switch (Optional/Sold Separately – Comes Standard when VQR Assembly is Ordered)
- 7 Series 729 Drip Check Valve
- 8 Diaphragm-Charge-Line Ball Valve (Normally Open)
- 9 3-in-1 Strainer/Check/Restrictor Assembly
- 10 Series 760 Water Motor Alarm (Optional/Sold Separately)
- 11 Alarm Test Ball Valve
- 12 Diaphragm-Charge-Line Pressure Gauge (0-300 psi/0-2068 kPa/0-20.7 Bar)
- 13 Series 749 Auto Drain
- 14 Series 776 Low-Pressure Actuator
- 15 Air Manifold
- 16 Air Supervisory Pressure Switch (Optional/Sold Separately – Comes Standard when VQR Assembly is Ordered)
- 17 System Pressure Gauge (0-80 psi/0-552 kPa/0-5.5 Bar with Retard)
- 18 Water Supply Main Drain Valve - Flow Test
- 19 Water Supply Pressure Gauge (0-300 psi/0-2068 kPa/0-20.7 Bar)
- 20 Drain Connection Kit (Optional/Sold Separately – Comes Standard when VQR Assembly is Ordered)
- 21 Gauge Valve
- 22 System Main Drain Valve
- 23 Series 755 Manual Pull Station
- 24 Series 748 Ball Check Valve
- 25 Series 746-LPA Dry Accelerator (Optional/Sold Separately)

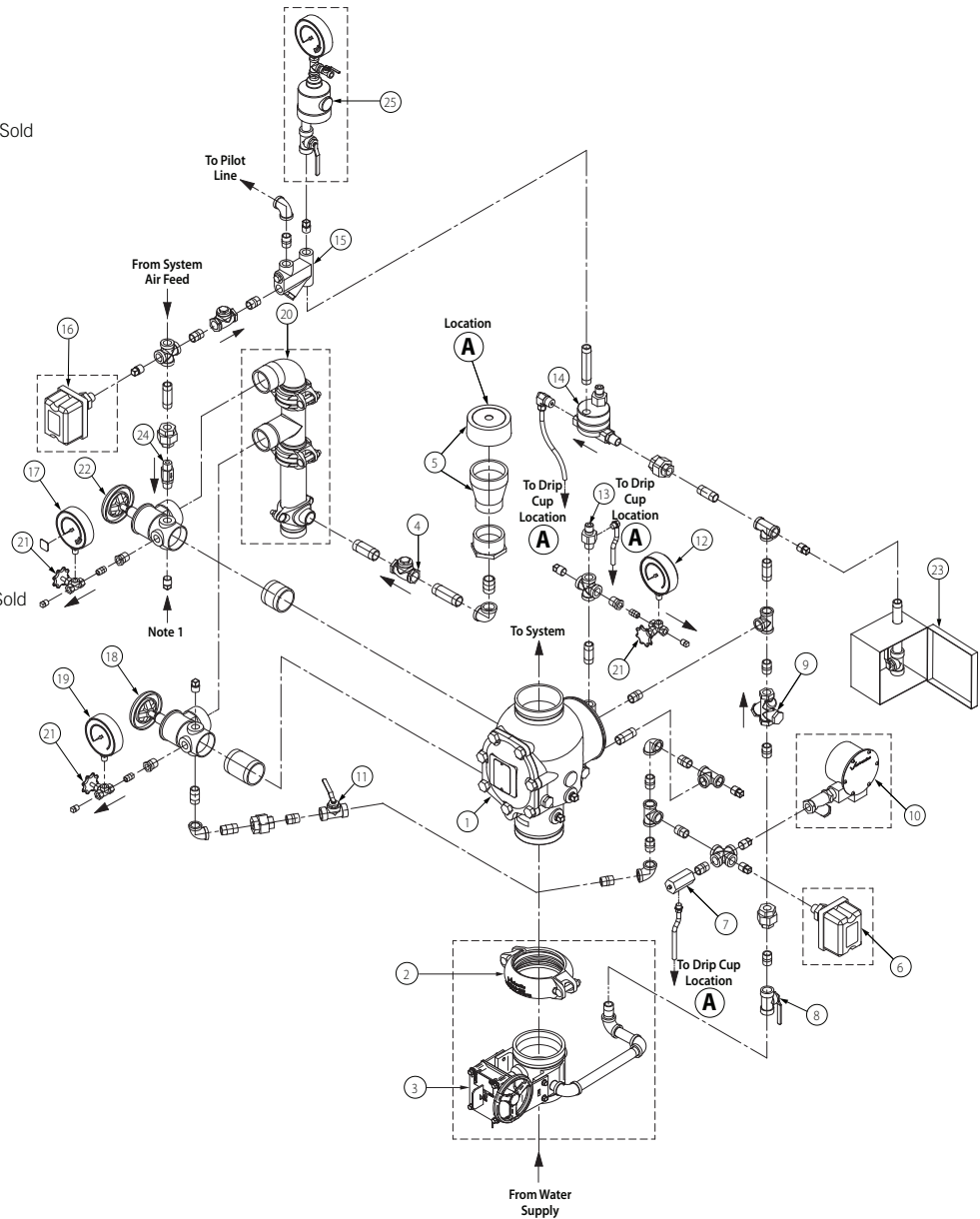

NOTE 1: Connection point for the Series 75D Water Column Device Kit

For information regarding installation of the Series 75B Supplemental Alarm Device or the Series 7C7 Air Maintenance/Compressor Assembly (not shown), refer to the instructions supplied with the product.

FireLock NXT™ Preaction Valve

SERIES 769

EXPLODED VIEW DRAWING – TRIM COMPONENTS

SERIES 769 FIRELOCK NXT PREACTION VALVE – SINGLE-INTERLOCKED, ELECTRIC RELEASE TRIM

SERIES 769 FIRELOCK NXT PREACTION VALVE – DOUBLE-INTERLOCKED, ELECTRIC RELEASE (ELECTRIC-PNEUMATIC/ELECTRIC) TRIM



(OPTIONAL ACCESSORIES ALSO SHOWN)

Bill of Materials

- 1 Series 769 FireLock NXT Preaction Valve
- 2 FireLock Rigid Coupling (Optional/Sold Separately – Comes Standard when VQR Assembly is Ordered)
- 3 Water Supply Main Control Valve (Optional/Sold Separately – Comes Standard when VQR Assembly is Ordered)
- 4 Drain Swing Check Valve
- 5 Drip Cup with Cap
- 6 Alarm Pressure Switch (Optional/Sold Separately – Comes Standard when VQR Assembly is Ordered)
- 7 Series 729 Drip Check Valve
- 8 Diaphragm-Charge-Line Ball Valve (Normally Open)
- 9 3-in-1 Strainer/Check/Restrictor Assembly
- 10 Series 760 Water Motor Alarm (Optional/Sold Separately)
- 11 Alarm Test Ball Valve
- 12 Diaphragm-Charge-Line Pressure Gauge (0-300psi/0-2068kPa/0-20.7 Bar)
- 13 Series 749 Auto Drain
- 14 Series 753-E Solenoid Valve
- 15 Air Supervisory Pressure Switch**
- 16 System Pressure Gauge (0-80psi/0-552kPa/0-5.5 Bar with Retard)
- 17 Water Supply Main Drain Valve - Flow Test
- 18 Water Supply Pressure Gauge (0-300psi/0-2068kPa/0-20.7 Bar)
- 19 Drain Connection Kit (Optional/Sold Separately – Comes Standard when VQR Assembly is Ordered)
- 20 Gauge Valve
- 21 System Main Drain Valve
- 22 Series 755 Manual Pull Station
- 23 Series 748 Ball Check Valve

**Item #15 is optional/sold separately (or standard when VQR assembly is ordered) for single-interlocked, electric release trim.
 **Item #15 is standard for double-interlocked, electric release (electric-pneumatic/electric) trim.

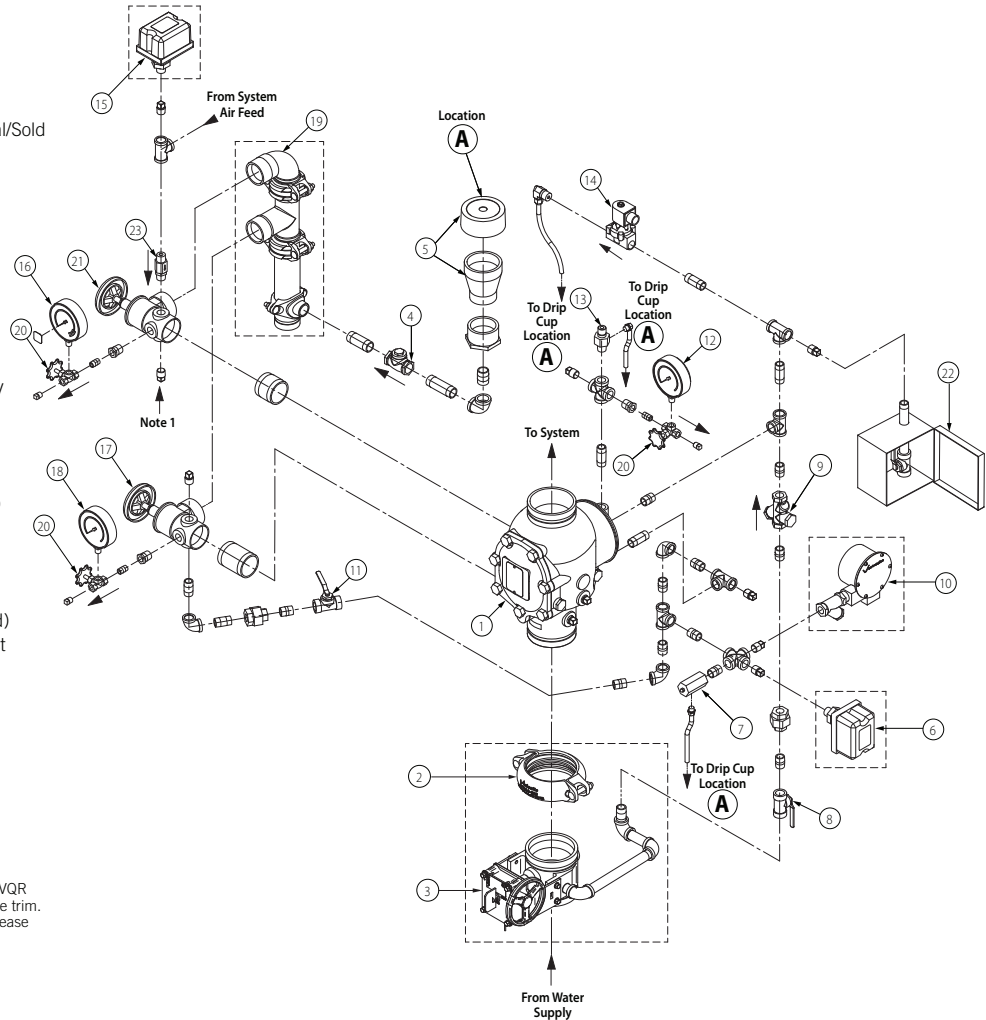

NOTE 1: Connection point for the Series 75D Water Column Device Kit

For information regarding installation of the Series 75B Supplemental Alarm Device or the Series 7C7 Air Maintenance/Compressor Assembly (not shown), refer to the instructions supplied with the product.

FireLock NXT™ Preaction Valve

SERIES 769

EXPLODED VIEW DRAWING – INTERNAL VALVE COMPONENTS

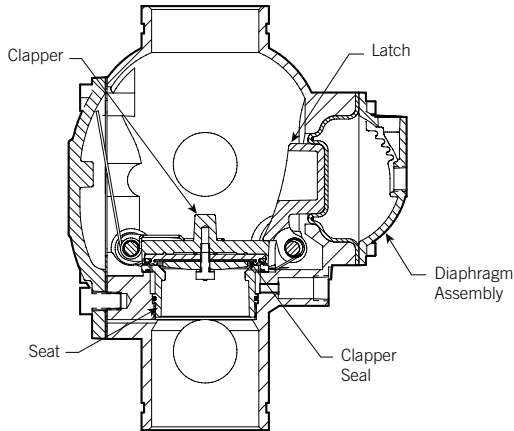

NOTE: VALVE IS SHOWN ABOVE IN THE "SET" POSITION
Exaggerated for Clarity

Bill of Materials

- | | |
|--|--|
| 1 Valve Body | 12 Cover Plate |
| 2 Clapper | 13 Cover Plate Gasket |
| 3 Clapper Seal | 14 Cover Plate Bolts* |
| 4 Seal Ring | 15 Latch |
| 5 Seal Washer | 16 Latch Spring |
| 6 Seal Retaining Ring | 17 Latch Shaft Bushing and O-Ring (Qty. 2) |
| 7 Seal Assembly Bolt | 18 Diaphragm |
| 8 Bolt Seal | 19 Diaphragm Cover |
| 9 Clapper Spring | 20 Diaphragm Cover Cap Screws (Qty. 8) |
| 10 Clapper Shaft | 21 Latch Shaft |
| 11 Clapper Shaft Bushing and O-Ring (Qty. 2) | |

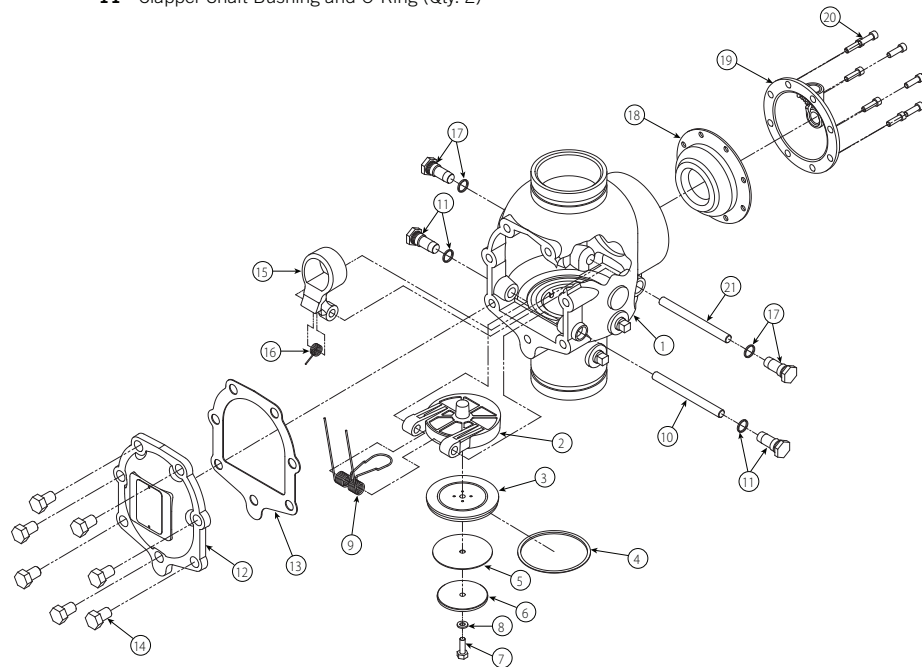

* NOTE: The 1½-inch/48.3-mm and 2-inch/60.3-mm valve sizes contain washers under the heads of the cover plate bolts.

FireLock NXT™ Preaction Valve

SERIES 769

SECTION VIEW DRAWING AND DESCRIPTION – SERIES 776 LOW-PRESSURE ACTUATOR

The Series 776 Low-Pressure Actuator is located in the trim of Series 769 FireLock NXT Preaction Valves and acts as the trigger for these systems.

Diaphragms separate the low-pressure actuator into three chambers. The upper air chamber controls activation, while the middle and lower chambers act as the water seal.

During setup, system air is applied to the upper chamber of the low-pressure actuator. When the Auto Vent Sleeve of the low-pressure actuator is pulled up, the upper chamber manually sets. Air pressure in the upper chamber holds the Auto Vent closed, while it exerts force on the water seal of the middle chamber.

When the diaphragm charge line is opened, water enters the lower chamber of the low-pressure actuator. Water that enters the low-pressure actuator flows to the middle chamber through the inlet eyelet, which is pressurized by system air pressure in the upper chamber.

Since the area of the lower diaphragm (exposed to water pressure in the middle chamber) is greater than the area of the lower chamber, the lower chamber seals off. Water does not flow to the outlet of the low-pressure actuator, and the supply water pressure creates the water seal.

When system air pressure decays to 7 psi/48 kPa/0.5 Bar, the force exerted by the compression spring in the Auto Vent is greater than the force exerted by air in the upper chamber. The Auto Vent opens, and all air pressure in the upper chamber evacuates.

The upper diaphragm releases water pressure in the middle chamber of the low-pressure actuator, which allows the lower diaphragm to lift and water to flow from the inlet to the outlet. This flow of water releases pressure from the diaphragm charge line of the Series 769 FireLock NXT Preaction Valve, thus allowing the diaphragm to retract. The clapper opens, and water flows into the sprinkler system.

Bill of Materials

- | | | | |
|---|-----------------------------|----|-------------------------------|
| 1 | Auto Vent Sleeve | 9 | Lower Diaphragm Assembly |
| 2 | Auto Vent Screw | 10 | Strainer Screen (Replaceable) |
| 3 | Auto Vent Assembly | 11 | Strainer O-Ring Seal |
| 4 | Upper Chamber | 12 | Strainer Assembly |
| 5 | Upper Diaphragm Wave Spring | 13 | Inlet Eyelet |
| 6 | Lower Diaphragm Wave Spring | 14 | Middle Chamber |
| 7 | Outlet Eyelet | 15 | Upper Diaphragm Assembly |
| 8 | Lower Chamber | | |

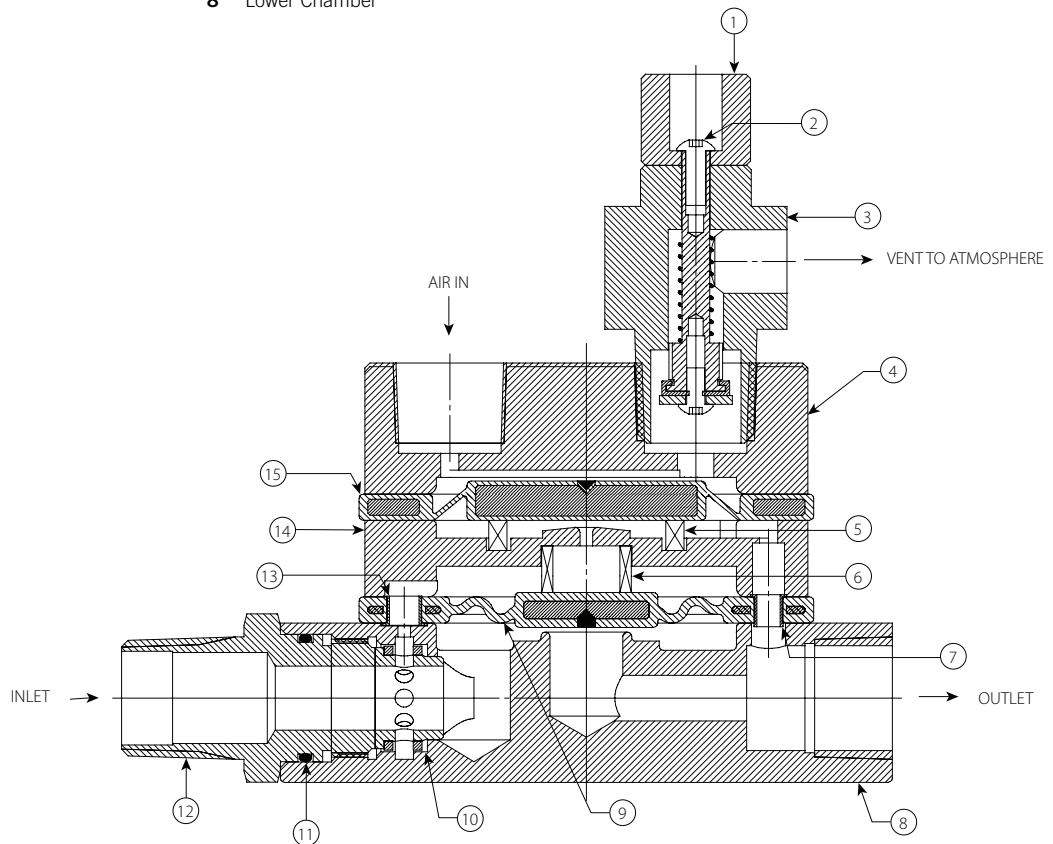

FireLock NXT™ Preaction Valve

SERIES 769

SECTION VIEW DRAWING AND DESCRIPTION – SERIES 746-LPA DRY ACCELERATOR

The Series 746-LPA Dry Accelerator is a quick-opening device, which exhausts air from the Series 776 Low-Pressure Actuator to speed valve operation.

A diaphragm separates the Series 746-LPA Dry Accelerator into two chambers. The closing chamber contains a compression spring, which maintains the chamber in the closed position. The closed position is maintained as long as the pressure differential between the opening and closing chambers is less than 3 psi/21 kPa/0.2 Bar.

When the system introduces air pressure into the dry accelerator, air enters the closing chamber and passes through a check valve to the opening chamber. The check valve, which allows flow into the opening chamber, prevents pressure from escaping the opening chamber. Therefore, air can escape only through the restrictor.

When a rapid loss of system air pressure occurs, such as an open sprinkler, air escapes from the closing chamber faster than it escapes from the opening chamber. As the sprinkler system's pressure continues to decay, a differential pressure develops across the diaphragm. When this differential pressure reaches 3 – 5 psi/21 – 34 kPa/0.2 – 0.3 Bar, the opening chamber's pressure overcomes the compression spring's closing force, causing the closing chamber to open to the atmosphere. The closing chamber opens immediately and releases pressure from the actuator, resulting in valve operation.

NOTE: The Series 746-LPA Dry Accelerator must be used only on systems operating below 30 psi/206 kPa/2.1 Bar of air. If air pressure higher than 30 psi/206 kPa/2.1 Bar is required, the Series 746 Dry Accelerator should be used.

Bill of Materials

- | | | | |
|---|---------------------|----|-----------------------|
| 1 | Opening/Air Chamber | 9 | O-Ring |
| 2 | Restrictor | 10 | Seal Support |
| 3 | Piston | 11 | Closing Chamber Seal |
| 4 | O-Ring | 12 | Button-Head Cap Screw |
| 5 | Diaphragm | 13 | Washer |
| 6 | Actuator Shaft | 14 | Adjustable Seat |
| 7 | Closing Chamber | 15 | Check Valve |
| 8 | Compression Spring | | |

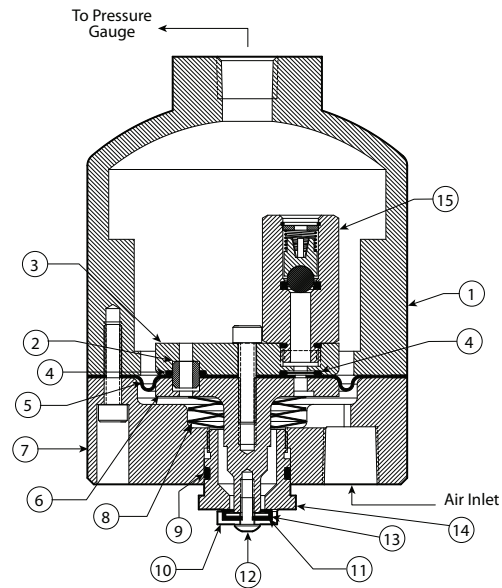

CROSS-SECTION WITH UPPER CHAMBER ROTATED
45° AND BOLT REMOVED FOR CLARITY

Exaggerated for Clarity

FireLock NXT™ Preaction Valve

SERIES 769

AIR SUPPLY REQUIREMENTS

The required air pressure for Series 769 FireLock NXT Preaction Valves is 13 psi/90 kPa/0.9 Bar minimum, regardless of the system supply water pressure. Normal air pressure should not exceed 18 psi/124 kPa/1.2 Bar. Failure to maintain air pressure within the 13 psi/90 kPa to 18 psi/124 kPa/1.2 Bar range may reduce system operation response time.

Systems with air pressure higher than 18 psi/124 kPa/1.2 Bar may require the addition of a Series 746-LPA Dry Accelerator. **NOTE:** The Series 746-LPA Dry Accelerator must be used only on systems operating below 30 psi/206 kPa/2.1 Bar of air. If air pressure higher than 30 psi/206 kPa/2.1 Bar is required, the Series 746 Dry Accelerator should be used.

If multiple Series 769 FireLock NXT Preaction Valves are installed with a common air supply, isolate the systems with a spring-loaded, soft-seated ball check valve to ensure air integrity for each system. Good practice is to include a ball valve for isolation and service of each individual system.

Set the air pressure to the required system air pressure. Air pressure differing from the required system air pressure could reduce system operation response time.

The engineer/system designer is responsible for sizing the compressor so that the entire system is charged to the required air pressure within 30 minutes. DO NOT oversize the compressor to provide more airflow. An oversized compressor will slow down or possibly prevent valve operation.

If the compressor fills the system too fast, it may be necessary to restrict the air supply. Restricting the air supply will ensure that air being exhausted from an open sprinkler or manual release valve is not replaced by the air supply system as fast as it is being exhausted.

COMPRESSOR SIZING

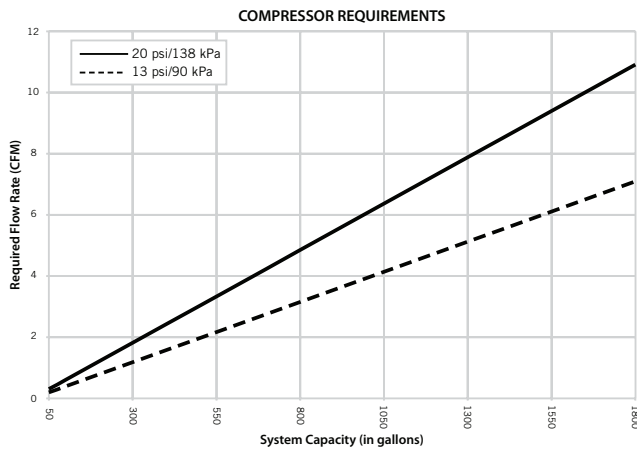

BASE OR RISER-MOUNTED AIR COMPRESSORS

For base or riser-mounted air compressors, the recommended air pressure of 13 psi/90 kPa/0.9 Bar is the “on” or “low” pressure setting for the compressor. The “off” or “high” pressure setting should be 18 psi/124 kPa/1.2 Bar.

When a base or riser-mounted air compressor supplies air to a Series 769 FireLock NXT Preaction Valve, it is not necessary to install the Victaulic Series 757 Regulated Air Maintenance Trim Assembly (AMTA). In this case, the air line of the compressor connects to the trim at the fitting where the Series 757 Regulated AMTA is normally installed (refer to the applicable trim drawing). If the compressor is not equipped with a pressure switch, the Series 757P Air Maintenance Trim Assembly with Pressure Switch should be installed.

SHOP AIR OR TANK-MOUNTED AIR COMPRESSORS

In the event a compressor becomes inoperative, a properly sized tank-mounted air compressor provides the greatest protection for systems.

When shop air or a tank-mounted air compressor is used, the Series 757 Regulated AMTA must be installed. The Series 757 Regulated AMTA provides proper air regulation from the air reservoir to the sprinkler system.

For tank-mounted air compressors, the recommended air pressure of 13 psi/90 kPa/0.9 Bar should be used as the set point for the air regulator. The “on” pressure of the compressor should be at least 5 psi/34 kPa/0.3 Bar above the set point of the air regulator.

VICTAULIC SERIES 757 REGULATED AIR MAINTENANCE TRIM ASSEMBLY (AMTA) OPTION

NOTICE

- Victaulic recommends a maximum of two Series 769 FireLock NXT Preaction Valves per Series 757 Regulated AMTA.

Bill of Materials

- 1 1/8" / 3.2 mm Restrictor
- 2 Slow Fill Ball Valve (Normally Open)
- 3 Air Regulator
- 4 Strainer (100 Mesh)
- 5 Spring-Loaded, Soft-Seated Ball Check Valve
- 6 Fast Fill Ball Valve (Normally Closed)

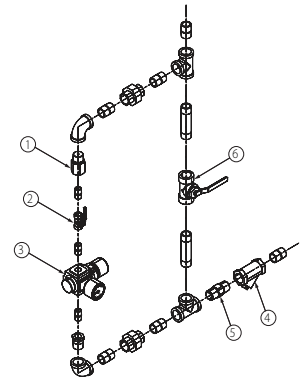

FireLock NXT™ Preaction Valve

SERIES 769

VICTAULIC SERIES 757P AIR MAINTENANCE TRIM ASSEMBLY (AMTA) WITH PRESSURE SWITCH OPTION

NOTICE

- Victaulic recommends a maximum of two Series 769 FireLock NXT Preaction Valves per Series 757P AMTA with Pressure Switch.
- Refer to the I-757P Air Maintenance Trim Assembly with Pressure Switch Installation Instructions, supplied with the product, for complete installation, electrical, and pressure switch adjustment information.

Bill of Materials

Item	Qty.	Description
1	1	Restrictor (½-inch NPT)
2	1	Strainer (½-inch NPT)
3	1	Swing Check (½-inch NPT)
4	1	Slow-Fill Ball Valve (Normally Open)
5	1	Spring-Loaded, Soft-Seated Check Valve
6	1	Pressure Switch
7	2	Compression Fitting, Straight (¼-inch NPT x ¼-inch Tube)
8	1	Copper Tubing (¼-inch OD)
9	11	Close Nipple (½-inch NPT x 1.13)
10	1	Nipple (½-inch NPT x 4.00)
11	1	90° Female Elbow (½-inch NPT)
12	4	Female Tee (½-inch NPT)
13	3	Union (½-inch NPT)
14	2	Reducing Bushing (½-inch NPT x ¼-inch NPT)
15	1	Fast-Fill Ball Valve (Normally Closed)
16	1	Pressure Switch Isolation Ball Valve (Normally Open - Lockable)

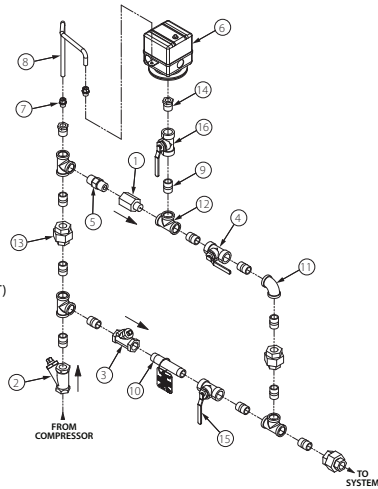

COMPRESSOR REQUIREMENTS AND SETTINGS FOR SERIES 769 FIRELOCK NXT PREACTION VALVES INSTALLED WITH SERIES 746-LPA DRY ACCELERATORS

Set the air regulator of the Series 757 Regulated AMTA to a minimum of 13 psi/90 kPa/0.9 Bar.

The Series 757P Air Maintenance Trim Assembly with Pressure Switch **MUST NOT** be used on a Series 769 FireLock NXT Preaction Valve installed with a Series 746-LPA Dry Accelerator, unless a tank and air regulator are added.

In the event a compressor becomes inoperative, a properly sized tank-mounted air compressor provides the greatest protection for systems installed with a Series 746-LPA Dry Accelerator. In this situation, air can be supplied continuously to the sprinkler system for an extended time period. **NOTE:** The Series 757 Regulated AMTA should be used with a tank-mounted air compressor to supply air to a Series 769 FireLock NXT Preaction Valve when the Series 746-LPA Dry Accelerator is used. The use of an air regulator with a base or riser-mounted air compressor could cause short cycling, resulting in premature wear of the compressor.

The air regulator of the Series 757 Regulated AMTA is a relief-type design. Any pressure in the system that is above the set point of the air regulator will be released. Therefore, charging the air regulator above the set point could cause premature operation of a valve installed with a Series 746-LPA Dry Accelerator.

SETTINGS FOR AIR SUPERVISORY PRESSURE SWITCHES AND ALARM PRESSURE SWITCHES

1. Air supervisory pressure switches are required for preaction systems and must be set according to the following notes. **NOTE:** Switches for Vic-Quick Risers are pre-set at the factory.
 - 1a. Wire the air supervisory pressure switches to activate a low-pressure alarm signal. **NOTE:** In addition, the local authority having jurisdiction may require a high-pressure alarm. Contact the local authority having jurisdiction for this requirement.
 - 1b. Set the air supervisory pressure switches to activate at 2 – 4 psi/14 – 28 kPa/0.1 – 0.3 Bar below the minimum air pressure required (but not lower than 10 psi/69 kPa/0.7 Bar).
 - 1c. Wire the alarm pressure switch to activate a water flow alarm.
 - 1d. Set the alarm pressure switch to activate on a pressure rise of 4 – 8 psi/28 – 55 kPa/0.3 – 0.6 Bar.

REMOTE SYSTEM TEST VALVE REQUIREMENTS

The remote system test valve (inspector’s test connection) should contain a UL Listed and/or FM Approved valve (normally closed), which can be opened to simulate the operation of a sprinkler.

The remote system test valve (inspector’s test connection) should be located at the most hydraulically demanding location in the release system. **NOTE:** Multiple restrictions on the remote system test valve (inspector’s test connection) may slow the air decay rate and cause the system to respond slower than required.

The remote system test valve (inspector’s test connection) should terminate with an orifice equal to the smallest orifice in the releasing system.

The remote system test valve (inspector’s test connection) is used to ensure that water reaches the most remote part of the system within 60 seconds.

FireLock NXT™ Preaction Valve

SERIES 769

IMPORTANT INSTALLATION INFORMATION

- For proper operation and approval, the Series 769 FireLock NXT Preaction Valve must be installed in accordance with the specific trim diagrams included with the shipment. **NOTE:** Victaulic provides specific trim diagrams for installations involving a Series 746-LPA Dry Accelerator.
- Before installing the Series 769 FireLock NXT Preaction Valve, flush the water supply piping thoroughly to remove all foreign material.
- Series 769 FireLock NXT Preaction Valves **MUST NOT** be located in an area where the valve can be exposed to freezing temperatures. In addition, the Series 769 FireLock NXT Preaction Valve **MUST NOT** be located in an area where physical damage may occur.
- It is the system designer's responsibility to confirm material compatibility of the Series 769 FireLock NXT Preaction Valve, trim, and associated accessories when a corrosive environment or contaminated water is present.
- SERIES 769 FIRELOCK NXT PREACTION VALVES MUST BE INSTALLED ONLY IN THE VERTICAL POSITION WITH THE ARROW ON THE BODY POINTING UPWARD.**
- Air or nitrogen supply to the dry piping system must be clean, dry, and oil-free.
- Air supplies must be regulated, restricted, and continuous.
- When an uninterruptible water flow alarm is required, Victaulic recommends the use of a low-pressure alarm installed on the diaphragm charge line downstream of the strainer/check restrictor. Another option is to install a Series 75B Supplemental Alarm Device.
- Per NFPA 13 requirements, piping must be pitched so that systems can drain properly. For areas that are subject to high levels of condensation, or where piping is not properly pitched, an optional Series 75D Water Column Device kit is available to assist in automatically draining water out of the riser.

VALVE/TRIM INSTALLATION

- Make sure the trim drawing matches the system's requirements.

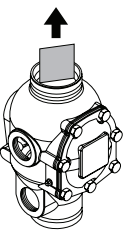
CAUTION	
	<ul style="list-style-type: none"> Make sure the foam spacer is removed from inside the valve body before attempting to install the valve. <p>Failure to follow this instruction could cause improper valve operation, resulting in personal injury and/or property damage.</p>

- Remove all plastic caps and foam spacers from the valve.
- Apply a small amount of pipe joint compound or Teflon* tape to the external threads of all threaded pipe connections. **DO NOT** get any tape, compound, or other foreign material into the valve body, pipe nipples, or valve openings.

* Teflon is a registered trademark of the DuPont Company

CAUTION
<ul style="list-style-type: none"> Make sure no foreign material gets into the valve body, pipe nipples, or valve openings. If using any material other than Teflon tape, use extra caution so that no material gets into the trim. <p>Failure to follow these instructions could cause improper valve operation, resulting in personal injury and/or property damage.</p>

- Install the valve, trim, and accessories per the trim drawing.

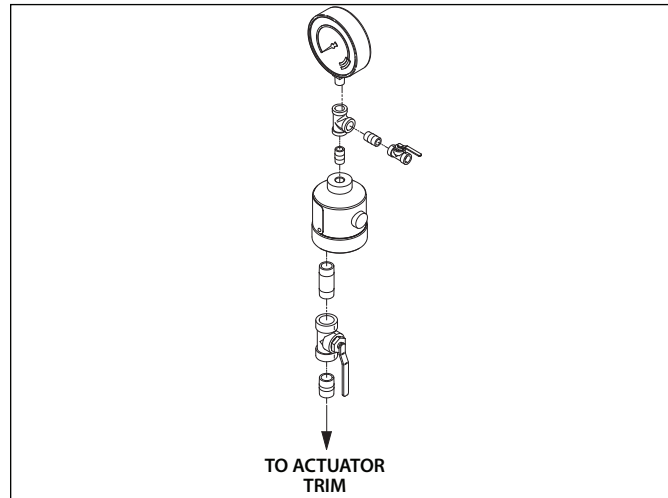

- FOR VALVES INSTALLED WITH A SERIES 746-LPA DRY ACCELERATOR:** Make sure the Series 746-LPA Dry Accelerator is installed in accordance with the trim drawing provided. The end with the vent seal "button" must be installed facing down (toward the trim).
- Supply pressure to the diaphragm charge line by providing an uninterrupted source of water from upstream of the main control valve.

FireLock NXT™ Preaction Valve

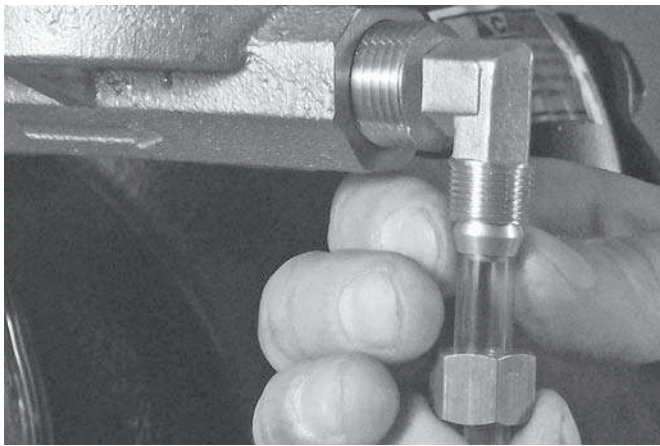
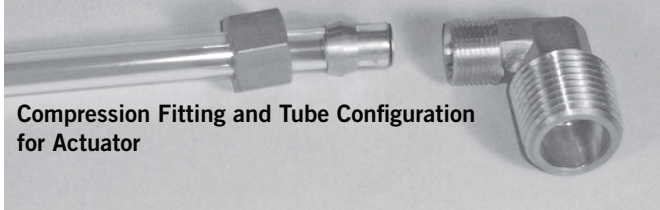
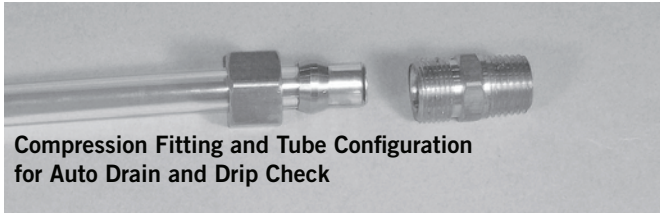

SERIES 769

COMPRESSION FITTING AND TUBE INSTALLATION



Compression fittings and tubes are provided for connection from the outlet of the auto drain, drip check, and actuator to the drip cup or drain. These compression fittings and tubes must be installed, in accordance with the trim drawing provided. **NEVER** insert a plug into the outlet of the auto drain, drip check, or actuator in place of the compression fitting/tube.

HYDROSTATIC TESTING

 WARNING	
	<ul style="list-style-type: none"> • If air testing is required, DO NOT exceed 50 psi/345 kPa/3.4 Bar air pressure. Failure to follow this instruction could result in serious personal injury and/or property damage.

The Victaulic Series 769 FireLock NXT Preaction Valve is UL Listed and FM Approved for a maximum working pressure of 300 psi/2065 kPa/ 20.7 Bar and is factory tested to 600 psi/4135 kPa/41.4 Bar for all sizes. The valve can be hydrostatically tested against the clapper at 200 psi/1380 kPa/13.8 Bar or 50 psi/345 kPa/3.4 Bar above the normal water supply pressure (2-hour limited time period) for acceptance by the authority having jurisdiction.

FireLock NXT™ Preaction Valve

SERIES 769

PLACING THE SYSTEM IN SERVICE

- NON-INTERLOCKED, PNEUMATIC RELEASE
- NON-INTERLOCKED PNEUMATIC/ELECTRIC RELEASE
- SINGLE-INTERLOCKED, PNEUMATIC RELEASE
- SINGLE-INTERLOCKED, ELECTRIC RELEASE
- DOUBLE-INTERLOCKED, ELECTRIC (ELECTRIC-PNEUMATIC/ELECTRIC) RELEASE

CAUTION

- Make sure the Series 769 FireLock NXT Preaction Valve is properly heated and protected from freezing temperatures and physical damage.

Failure to follow this instruction could cause improper valve operation, resulting in personal injury and/or property damage.

NOTICE

- A non-interlocked, pneumatic release system is shown in the photos below.

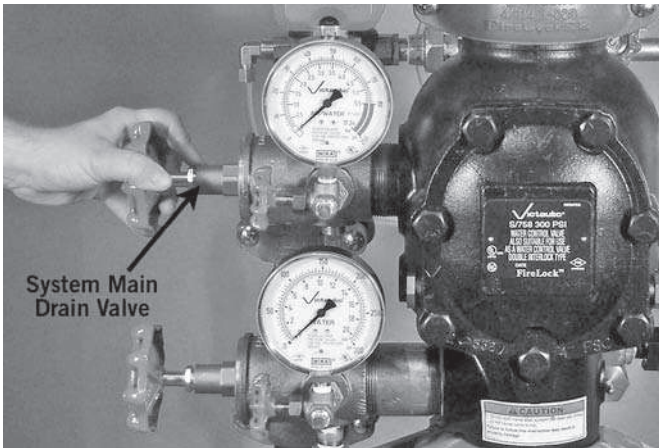

1. Open the system main drain valve. Confirm that the system is drained.

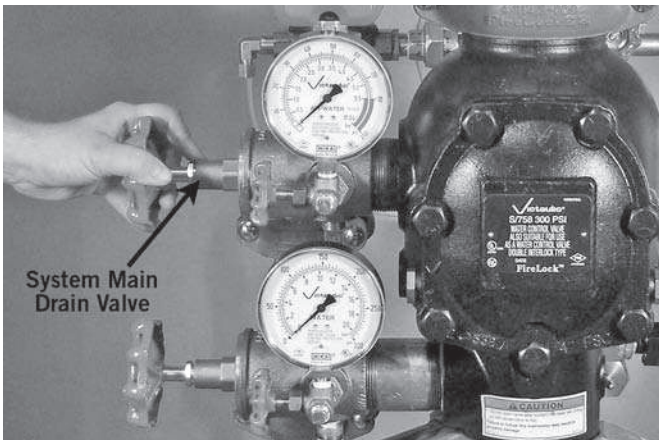

2. Close the system main drain valve.

3. Confirm that all system drains are shut and that the system is free of leaks.
 - 3a. Confirm that the system has been depressurized. The gauges should indicate zero pressure.

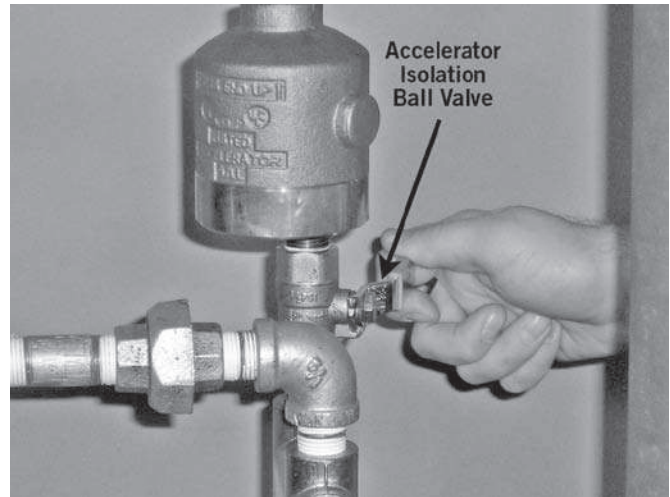

4. **FOR SYSTEMS INSTALLED WITH A SERIES 746-LPA DRY ACCELERATOR:** Confirm that the isolation ball valve to the accelerator is closed.

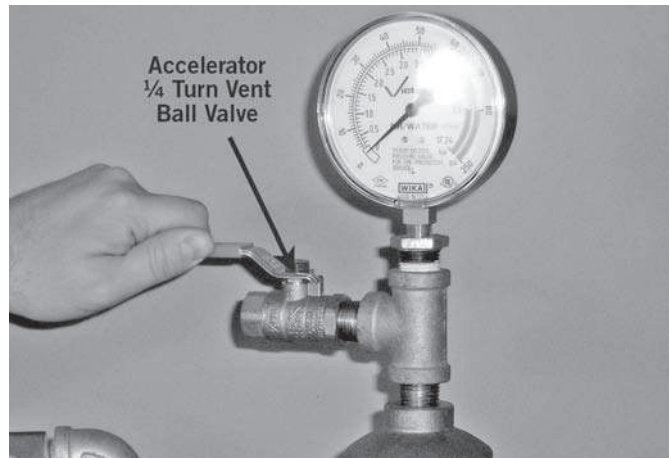

- 4a. **FOR SYSTEMS INSTALLED WITH A SERIES 746-LPA DRY ACCELERATOR:** Open the 1/4-turn vent ball valve.

FireLock NXT™ Preaction Valve

SERIES 769

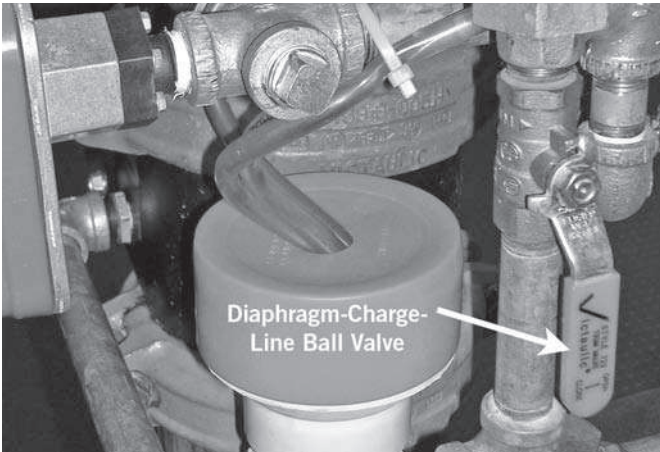

5. Open the diaphragm-charge-line ball valve.

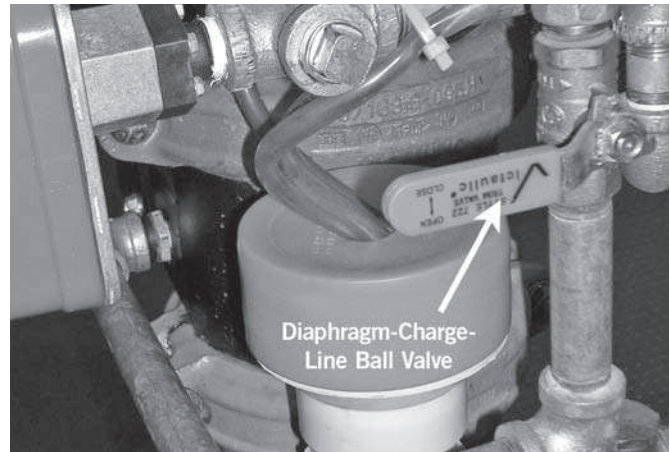

9. Close the diaphragm-charge-line ball valve.

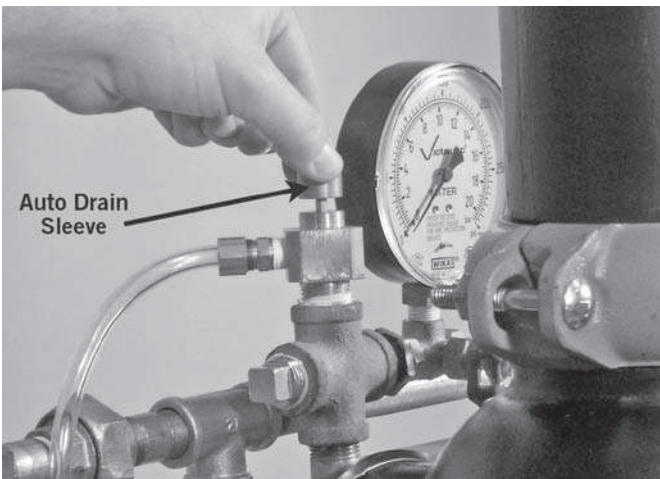

6. Confirm that water is flowing steadily from the Auto Drain. Pull up on the Auto Drain Sleeve.
7. **FOR SYSTEMS INSTALLED WITH A SERIES 776 LOW-PRESSURE ACTUATOR:** Confirm that water is flowing through the Series 776 Low-Pressure Actuator after opening the diaphragm-charge-line ball valve and pulling up on the Auto Drain Sleeve.
8. **FOR SYSTEMS INSTALLED WITH A SERIES 753-E SOLENOID VALVE:** Make sure no water flows through the solenoid after opening the diaphragm-charge-line ball valve. DO NOT pull up on the Auto Drain Sleeve.

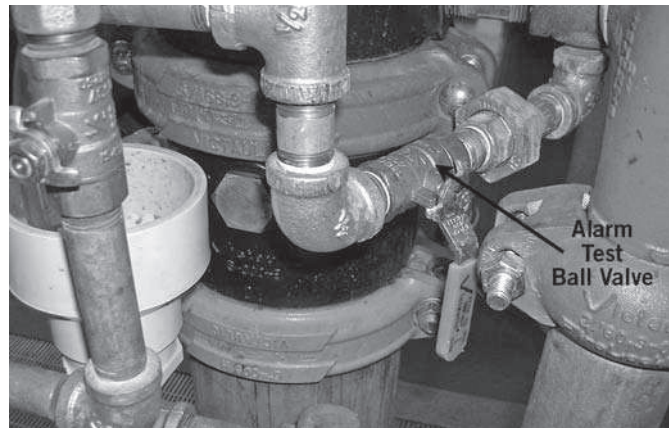
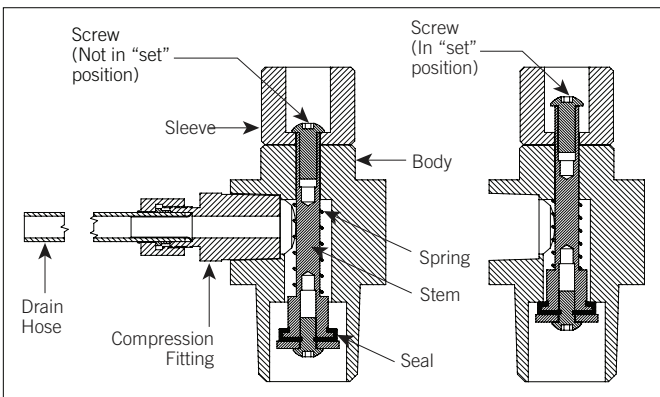

10. Confirm that the alarm test ball valve is closed.

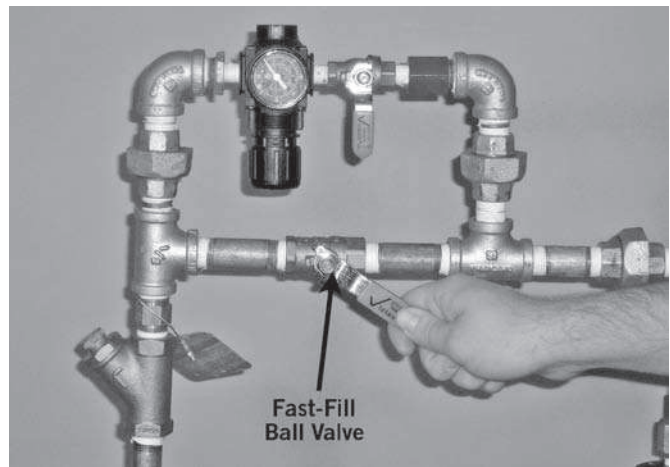

11. Charge the system with air by turning on the compressor or by opening the fast-fill ball valve on the AMTA (fast-fill ball valve is shown above). Charge the system to 13 psi/90 kPa/0.9 Bar minimum. Refer to the "Air Supply Requirements" section.
12. Confirm that the system is charging by observing the air pressure gauge. If the gauge is not showing an increase in air pressure, there is a leak or an opening in the line. Repair any leaks or openings and restart the setup procedures.

FireLock NXT™ Preaction Valve

SERIES 769

13. **FOR SYSTEMS INSTALLED WITH A SERIES 776 LOW-PRESSURE ACTUATOR:** Confirm that no water is being exhausted from the Auto Vent of the Series 776 Low-Pressure Actuator. If water is being exhausted from the Auto Vent, continue to run air through the system in order to remove moisture from the upper chamber of the Series 776 Low-Pressure Actuator. If a Series 746-LPA Dry Accelerator is installed, make sure the accelerator is not flooded.

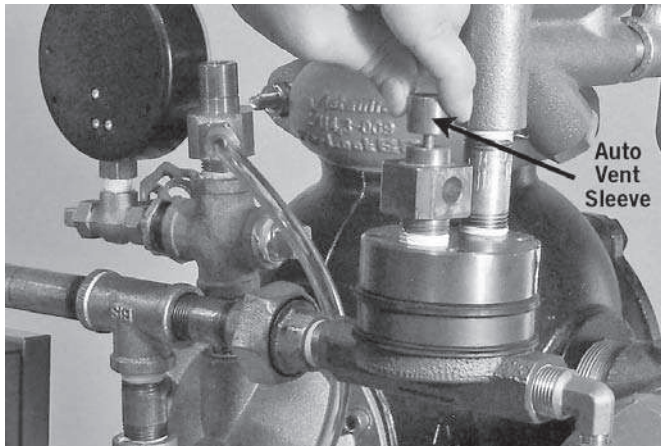

14. **FOR SYSTEMS INSTALLED WITH A SERIES 776 LOW-PRESSURE ACTUATOR:** When the system reaches approximately 10psi/69kPa/0.7 Bar, and no additional moisture is being released from the Auto Vent, pull up on the Auto Vent Sleeve of the Series 776 Low-Pressure Actuator. **NOTE:** The Auto Vent Screw should seal and remain in the set (“UP”) position.

15. **FOR SYSTEMS INSTALLED WITH A SERIES 753-E SOLENOID VALVE:** Confirm that the solenoid is closed.

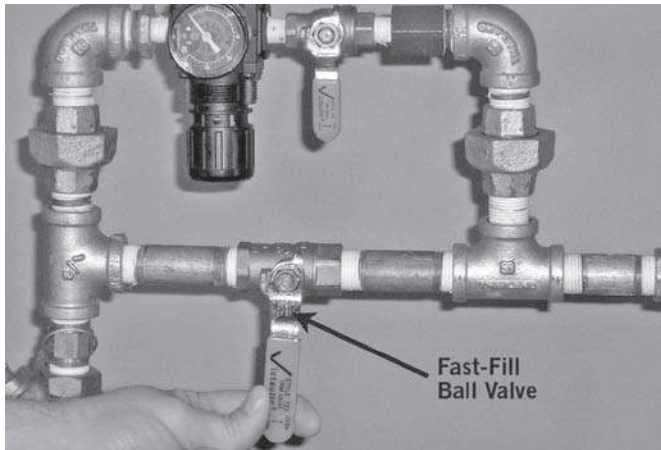

16. When system air pressure is established, close the fast-fill ball valve on the AMTA.

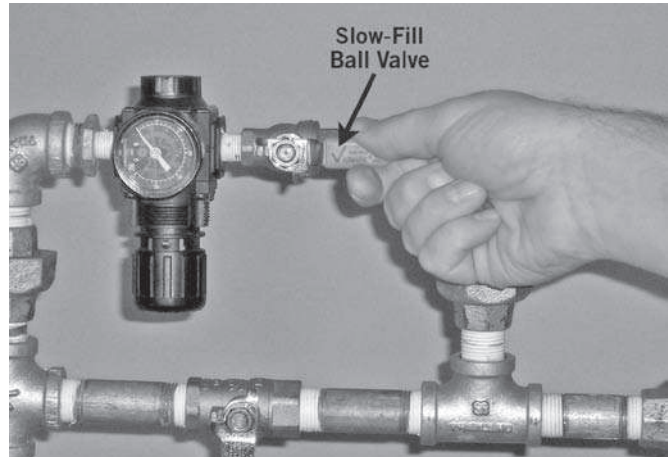

17. Open the slow-fill ball valve on the AMTA. **NOTE:** Failure to leave the slow-fill ball valve open may allow system pressure to drop, resulting in valve operation in the event of a system leak.

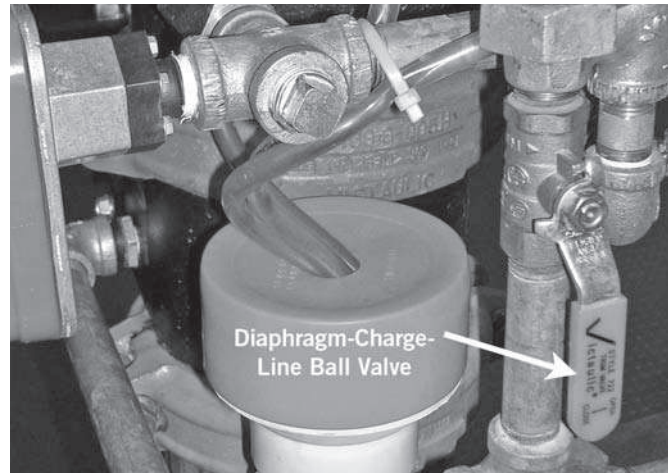

18. Open the diaphragm-charge-line ball valve. Allow water to flow through the Auto Drain tube.



19. Open the manual pull station.

FireLock NXT™ Preaction Valve

SERIES 769

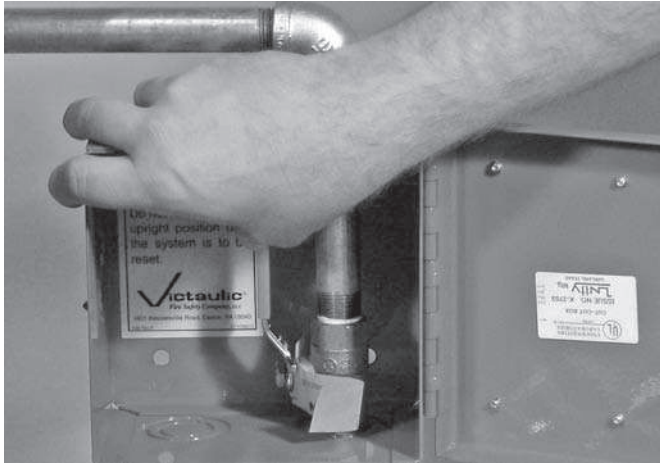

20. Close the manual pull station.

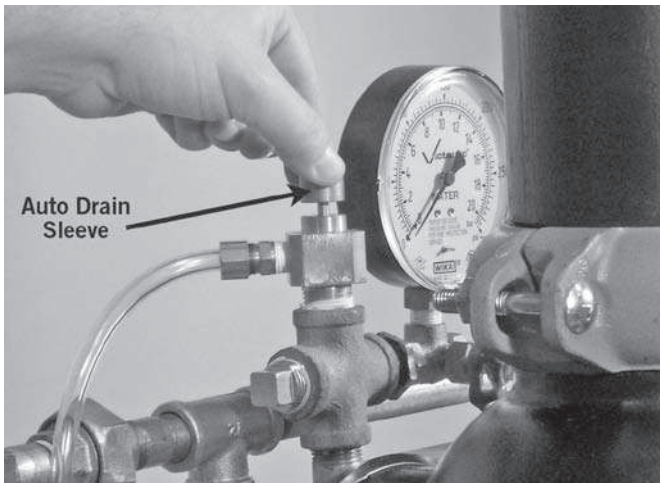

21. Pull up on the Auto Drain Sleeve until the screw is in the set ("UP") position. Verify that there is pressure on the gauge to the diaphragm charge line.

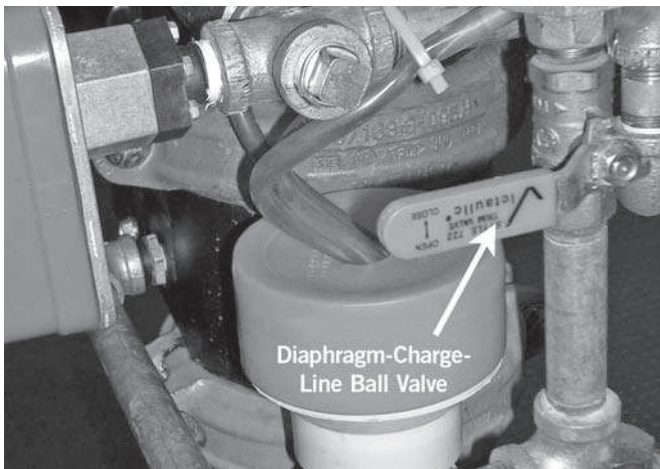

22. When the diaphragm charge line is pressurized, temporarily close the diaphragm-charge-line ball valve. Confirm that the diaphragm charge line is maintaining pressure by observing the diaphragm-charge-line pressure gauge.

22a. If pressure in the diaphragm charge line drops, the diaphragm must be replaced and/or any leaks in the diaphragm charge line must be corrected. Refer to the "Removing and Replacing the Diaphragm Assembly" section.

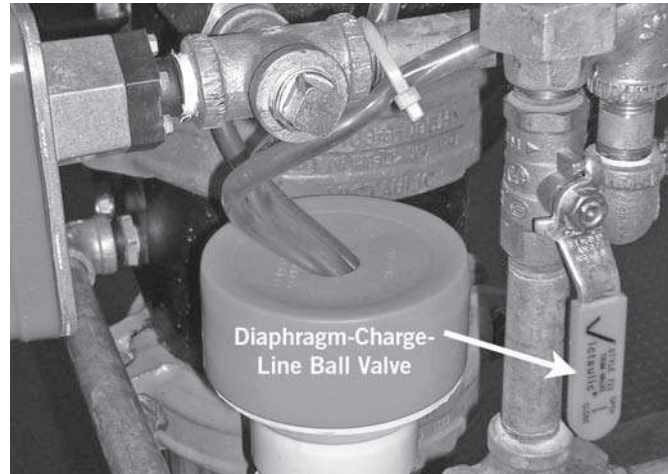

22b. If pressure in the diaphragm charge line does not drop, re-open the diaphragm-charge-line ball valve, and proceed to the following step.

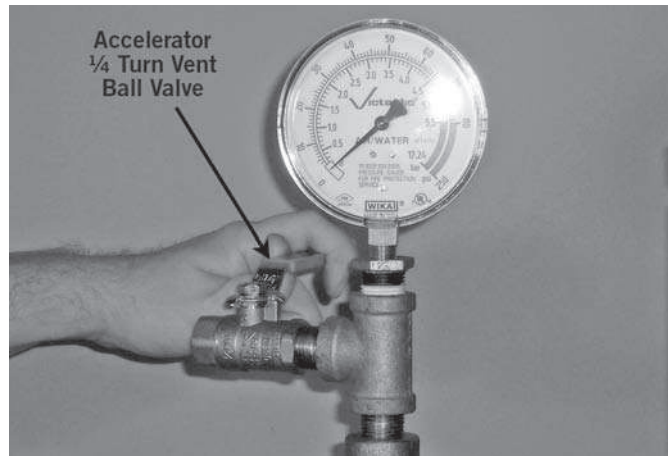

23. **FOR SYSTEMS INSTALLED WITH A SERIES 746-LPA DRY ACCELERATOR:** Close the ¼-turn vent ball valve on the accelerator.

FireLock NXT™ Preaction Valve

SERIES 769

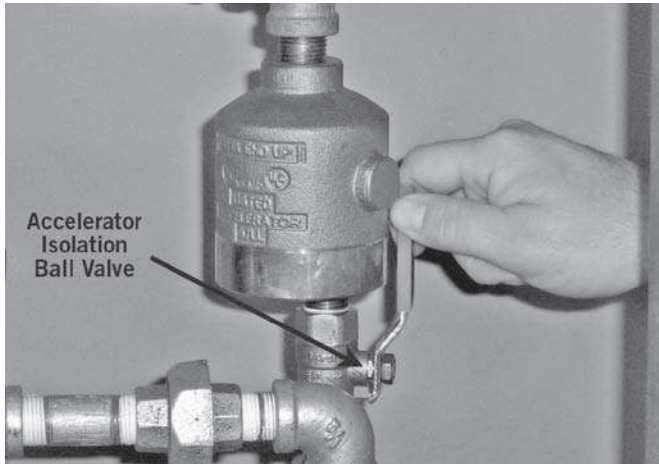

24. **FOR SYSTEMS INSTALLED WITH A SERIES 746-LPA DRY ACCELERATOR:** Open the isolation ball valve. This will set the accelerator
25. Observe the system air pressure over a 24-hour period to confirm system integrity. If there is degradation in system air pressure, find and correct all leaks. **NOTE:** NFPA requires less than 1½-psi/ 14-kPa/0.1-Bar leakage in 24 hours.

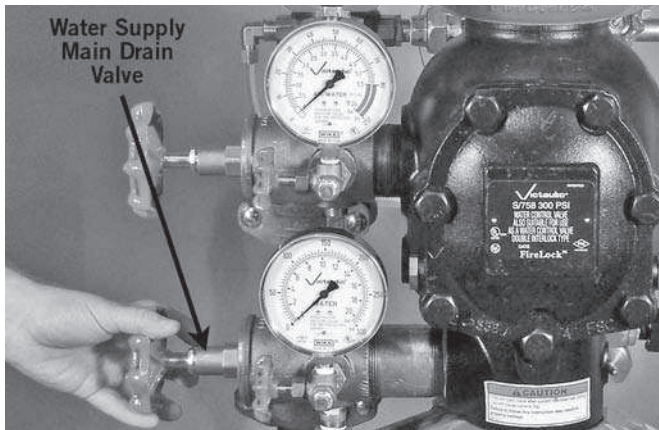

26. Open the water supply main drain valve.

⚠ CAUTION

- Take precautions when opening the water supply main control valve, since water will flow from all open system valves. Failure to follow this instruction could result in property damage.

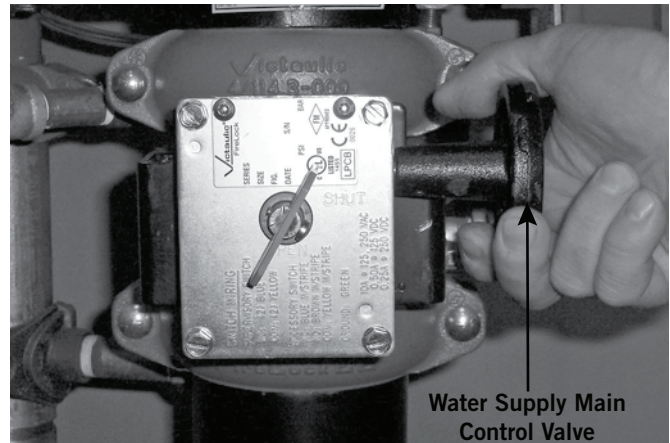

27. Open the water supply main control valve slowly until water flows steadily from the open water supply main drain valve.

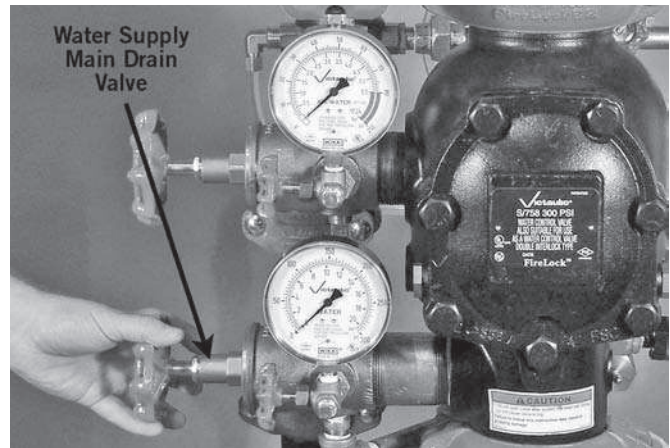

28. Close the water supply main drain valve when a steady flow of water occurs.

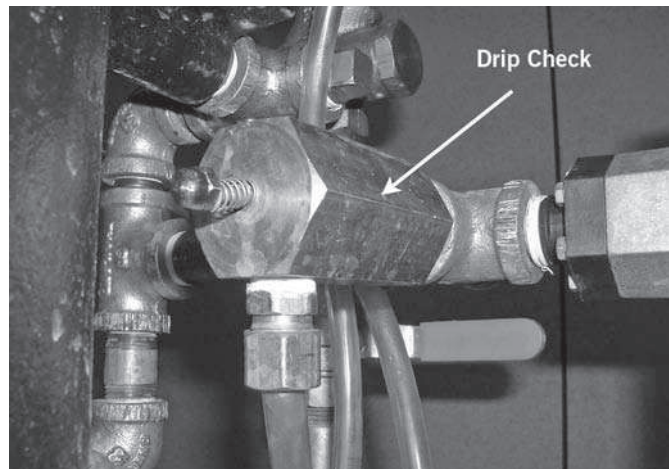

29. Confirm that there is no leakage from the intermediate valve chamber. The drip check in the alarm line should not be leaking water or air.

FireLock NXT™ Preaction Valve

SERIES 769

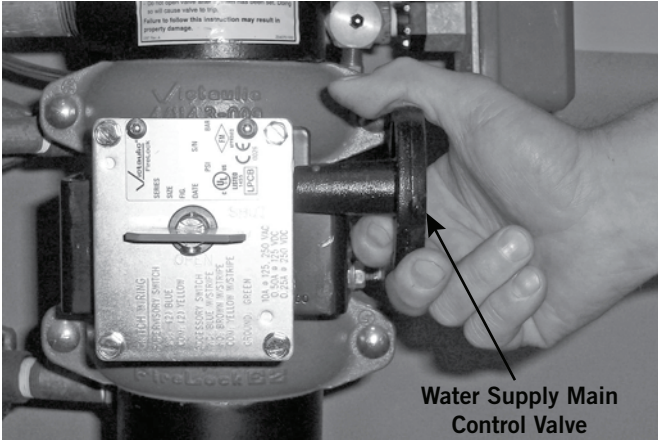

Water Supply Main Control Valve

ON A WEEKLY BASIS, WHEN THE VALVE IS RESET AFTER AN OPERATIONAL TEST (OR AFTER ANY SYSTEM OPERATION): The main drain valve and any low-point drain valves should be partially opened and then closed to drain water that might be present in the riser. Continue this procedure until all water is released. **NOTE:** The optional Series 75D Water Column Kit can be installed to automate this step.

30. If water is flowing from the drip check, close the water supply 30 control valve, and start over at step 1. Refer to the “Troubleshooting” section.

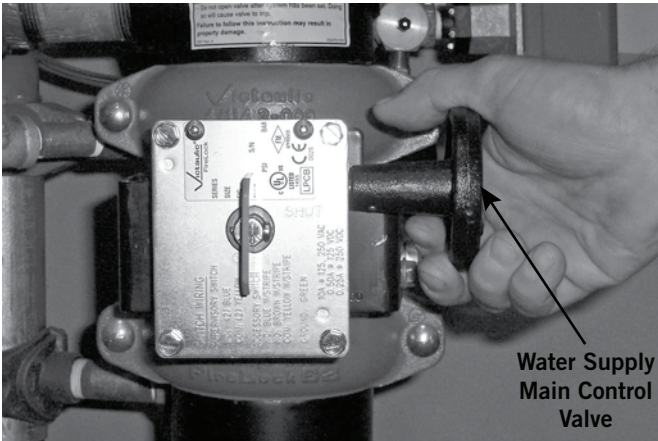

Water Supply Main Control Valve

31. Open the water supply main control valve fully.
32. Record the system air pressure and the water supply pressure.
33. Confirm that all valves are in their normal operating positions (refer to the table below).

Valve	Normal Operating Position
Diaphragm-Charge-Line Ball Valve	Open
Alarm Test Ball Valve	Closed
Water Supply Main Control Valve	Open
Water Supply Main Drain Valve	Closed
System Main Drain Valve	Closed
Slow-Fill Ball Valve of the Victaulic AMTA (if applicable)	Open
Fast-Fill Ball Valve of the Victaulic AMTA (if applicable)	Closed
Isolation Ball Valve for Series 746-LPA Dry Accelerator (if applicable)	Open
¼-Turn Vent Ball Valve for Series 746-LPA Dry Accelerator (if applicable)	Closed

34. Notify the authority having jurisdiction, remote station alarm monitors, and those in the affected area that the system is in service.

FireLock NXT™ Preaction Valve

SERIES 769

EXTERNAL INSPECTION

WARNING

- The building owner or their representative is responsible for maintaining the fire protection system in proper operating condition.
 - To ensure proper system operation, valves must be inspected in accordance with current NFPA-25 requirements or in accordance with the requirements of the local authority having jurisdiction (whichever is more stringent). Always refer to the instructions in this manual for additional inspection and testing requirements.
 - The frequency of inspections must be increased in the presence of contaminated water supplies, corrosive/scaling water supplies, and corrosive atmospheres.
 - Depressurize and drain the piping system before attempting to install, remove, adjust, or maintain any Victaulic products.
- Failure to follow these instructions could cause system failure, resulting in death, serious personal injury, and property damage.

NOTICE

- Any activities that require taking the valve out of service may eliminate the fire protection provided.
- Consideration of a fire patrol should be given for the affected areas.
- Before servicing or testing the system, notify the authority having jurisdiction.

WEEKLY INSPECTION

1. Perform a visual inspection on the valve and trim on a weekly basis. **NOTE:** If the preaction system is equipped with a low-pressure alarm, monthly inspections may be sufficient. Contact the local authority having jurisdiction for specific requirements.

MONTHLY INSPECTION

1. Record the system air pressure and water supply pressure. Confirm that the water supply pressure is within the range of normal pressures observed in the area. Significant loss of water supply pressure could indicate an adverse condition in the water supply. Confirm the proper water-to-air ratio is being maintained.

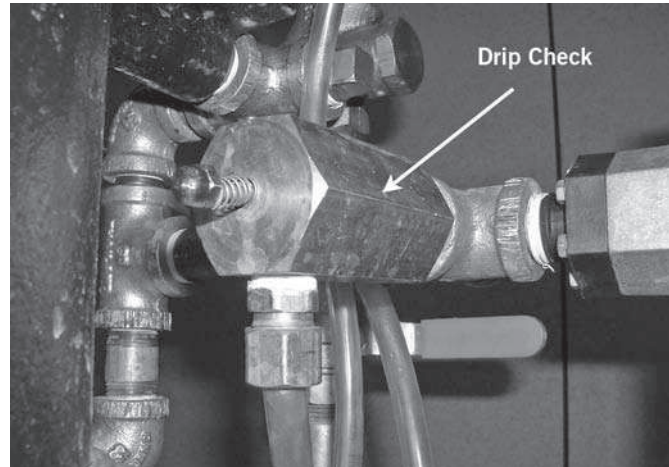

2. Confirm that there is no leakage from the intermediate valve chamber. The drip check in the alarm line should not be leaking water or air.
3. Inspect the valve and trim for mechanical damage and corrosion. Replace any damaged or corroded parts.
4. Confirm that the preaction valve and trim are located in an area that is not subject to freezing temperatures.
5. Confirm that all valves are in their normal operating positions (refer to the table below).

Valve	Normal Operating Position
Diaphragm-Charge-Line Ball Valve	Open
Alarm Test Ball Valve	Closed
Water Supply Main Control Valve	Open
Water Supply Main Drain Valve	Closed
System Main Drain Valve	Closed
Slow-Fill Ball Valve of the Victaulic AMTA (if applicable)	Open
Fast-Fill Ball Valve of the Victaulic AMTA (if applicable)	Closed
Isolation Ball Valve for Series 746-LPA Dry Accelerator (if applicable)	Open
¼-Turn Vent Ball Valve for Series 746-LPA Dry Accelerator (if applicable)	Closed

6. If a Series 746-LPA Dry Accelerator is installed, record the pressure in the air chamber of the dry accelerator. The pressure in the air chamber should equal the system air pressure within the allowable tolerances of the gauges. If the air chamber's pressure is below the system air pressure, follow the "Troubleshooting" section.

FireLock NXT™ Preaction Valve

SERIES 769

REQUIRED TESTS

WARNING

- The building owner or their representative is responsible for maintaining the fire protection system in proper operating condition.
- To ensure proper system operation, valves must be inspected in accordance with current NFPA-25 requirements or in accordance with the requirements of the local authority having jurisdiction (whichever is more stringent). Always refer to the instructions in this manual for additional inspection and testing requirements.
- The frequency of inspections must be increased in the presence of contaminated water supplies, corrosive/scaling water supplies, and corrosive atmospheres.
- Depressurize and drain the piping system before attempting to install, remove, adjust, or maintain any Victaulic products.

Failure to follow these instructions could cause system failure, resulting in death, serious personal injury, and property damage.

NOTICE

- Any activities that require taking the valve out of service may eliminate the fire protection provided.
- Consideration of a fire patrol should be given for the affected areas.
- Before servicing or testing the system, notify the authority having jurisdiction.

MAIN DRAIN TEST

Perform the main drain test on a frequency required by the current NFPA-25 code. The authority having jurisdiction in the area may require these tests on a more frequent basis. Verify these requirements by contacting the authority having jurisdiction in the affected area.

1. Notify the authority having jurisdiction, remote station alarm monitors, and those in the affected area that the main drain test will be performed.
2. Confirm that sufficient drainage is available.
3. Record the water supply pressure and system air pressure.

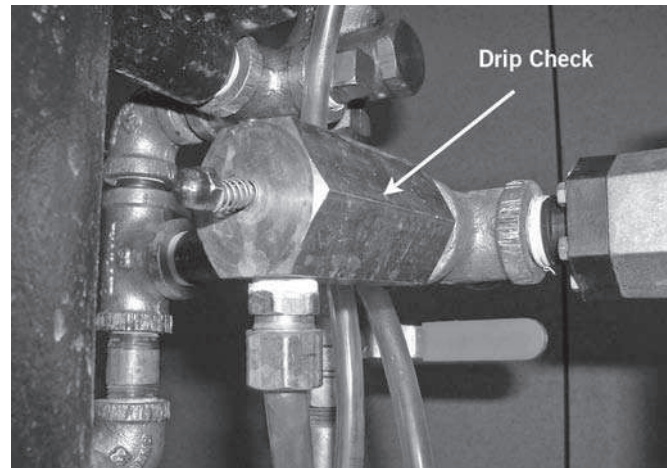

4. Confirm that there is no leakage from the intermediate valve chamber. The drip check in the alarm line should not be leaking water or air.
5. Verify that the system is at the proper air pressure for the local water supply pressure.

CAUTION

- Use caution to prevent opening the system main drain valve accidentally.

Opening the system main drain valve will cause the valve to operate, resulting in property damage.

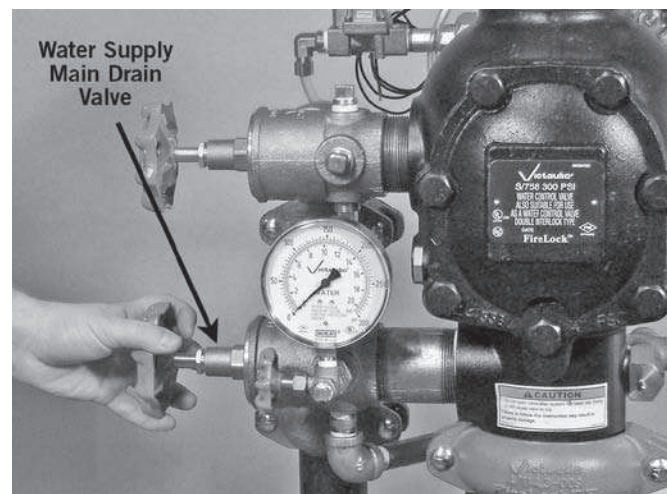

6. Open the water supply main drain valve fully to flush the water supply of any contaminants.
7. While the water supply main drain valve is fully open, record the water supply pressure (from the water supply gauge) as the residual pressure.

FireLock NXT™ Preaction Valve

SERIES 769

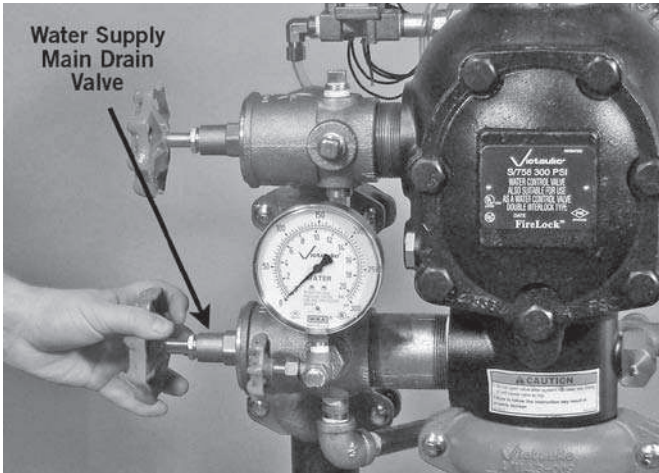

13. Notify the authority having jurisdiction, remote station alarm monitors, and those in the affected area that the valve is back in service.
14. Provide test results to the authority having jurisdiction, if required.

8. Close the water supply main drain valve slowly.
9. Record the water pressure established after closing the water supply main drain valve.
10. Compare the residual pressure reading, taken above, to the residual pressure readings taken in previous main drain tests. If there is degradation in the residual water supply reading, restore the proper water supply pressure.
11. Confirm that all valves are in their normal operating positions (refer to the table below).

Valve	Normal Operating Position
Diaphragm-Charge-Line Ball Valve	Open
Alarm Test Ball Valve	Closed
Water Supply Main Control Valve	Open
Water Supply Main Drain Valve	Closed
System Main Drain Valve	Closed
Slow-Fill Ball Valve of the Victaulic AMTA (if applicable)	Open
Fast-Fill Ball Valve of the Victaulic AMTA (if applicable)	Closed
Isolation Ball Valve for Series 746-LPA Dry Accelerator (if applicable)	Open
¼-Turn Vent Ball Valve for Series 746-LPA Dry Accelerator (if applicable)	Closed

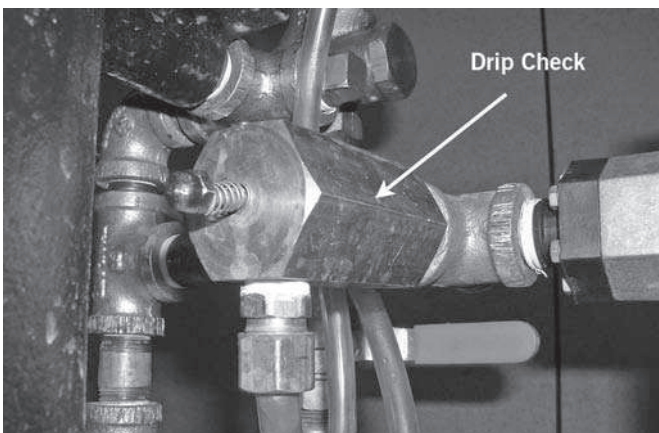

12. Confirm that there is no leakage from the intermediate valve chamber. The drip check in the alarm line should not be leaking water or air.

FireLock NXT™ Preaction Valve

SERIES 769

WATER FLOW ALARM TEST

Perform the water flow alarm test on a frequency required by the current NFPA-25 code. The authority having jurisdiction in the area may require these tests on a more frequent basis. Verify these requirements by contacting the authority having jurisdiction in the affected area.

1. Notify the authority having jurisdiction, remote station alarm monitors, and those in the affected area that the water flow alarm test will be performed.

⚠ CAUTION

- Use caution to prevent opening the system main drain valve accidentally.

Opening the system main drain valve will cause the valve to operate, resulting in property damage.

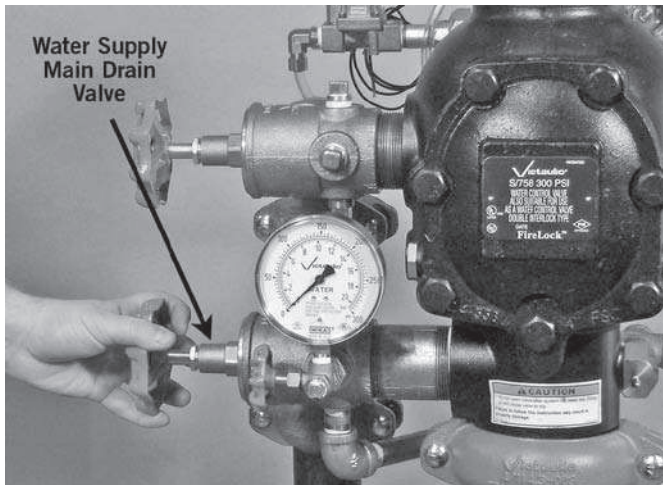

2. Open the water supply main drain valve fully to flush the water supply of any contaminants.

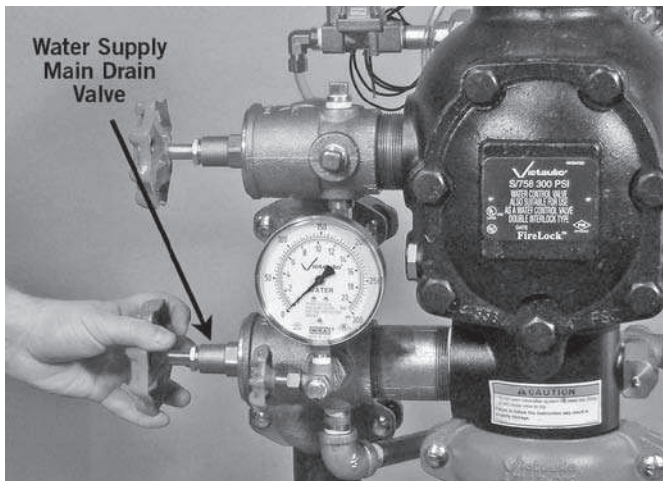

3. Close the water supply main drain valve.

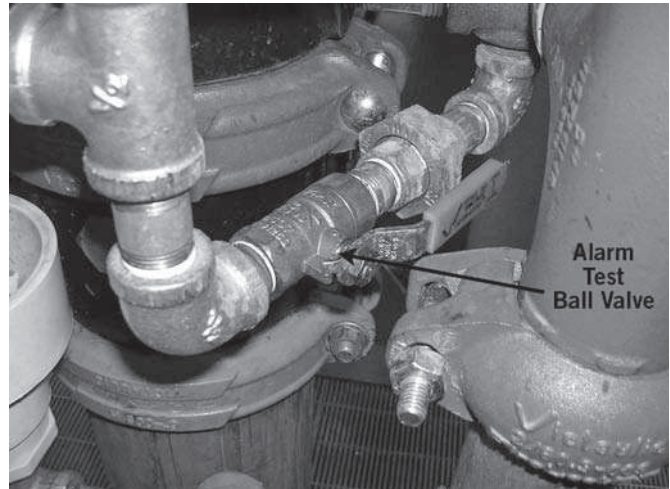

4. Open the alarm test ball valve. Confirm that mechanical and electrical alarms are activated and that remote monitoring stations, if provided, receive an alarm signal.

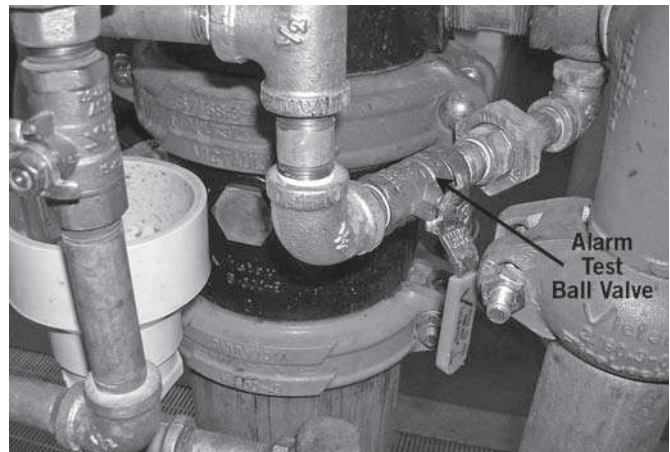

5. Close the alarm test ball valve after verifying proper operation of all alarms.

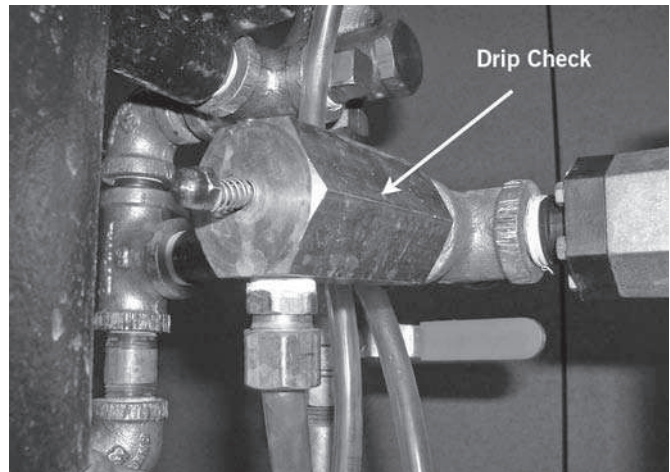

6. Push in the plunger of the drip check to verify that there is no pressure in the alarm line.

FireLock NXT™ Preaction Valve

SERIES 769

7. Verify that all alarms stopped sounding, that the alarm line drained properly, and that remote station alarms reset properly.
8. Confirm that there is no leakage from the intermediate valve chamber. The drip check in the alarm line should not be leaking water or air.
9. Notify the authority having jurisdiction, remote station alarm monitors, and those in the affected area that the valve is back in service.
10. Provide test results to the authority having jurisdiction, if required.

WATER LEVEL AND LOW AIR ALARM TESTS

Perform the water level and low air alarm tests on a frequency required by the current NFPA-25 code. The authority having jurisdiction in the area may require these tests on a more frequent basis. Verify these requirements by contacting the authority having jurisdiction in the affected area.

NOTICE

- If a Series 746-LPA Dry Accelerator is installed, make sure the authority having jurisdiction is notified that the water level and low air alarm tests are in progress. Failure to close the isolation ball valve of the Series 746-LPA Dry Accelerator may cause the valve to trip, resulting in a false alarm.

1. Notify the authority having jurisdiction, remote station alarm monitors, and those in the affected area that the water level and low air alarm tests will be performed.

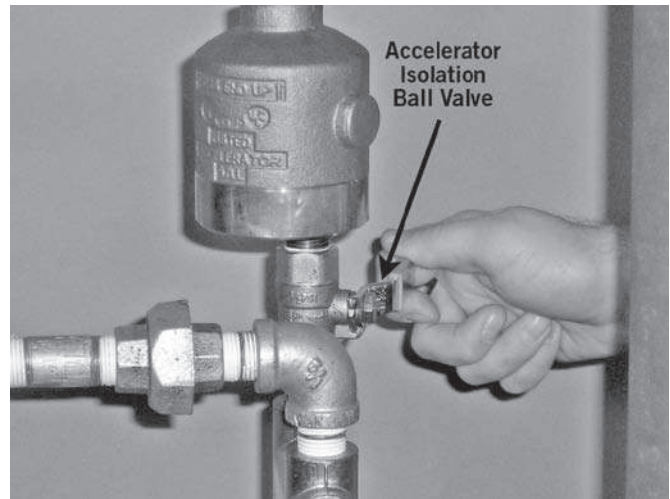

2. If a Series 746-LPA Dry Accelerator is installed, close the isolation ball valve.

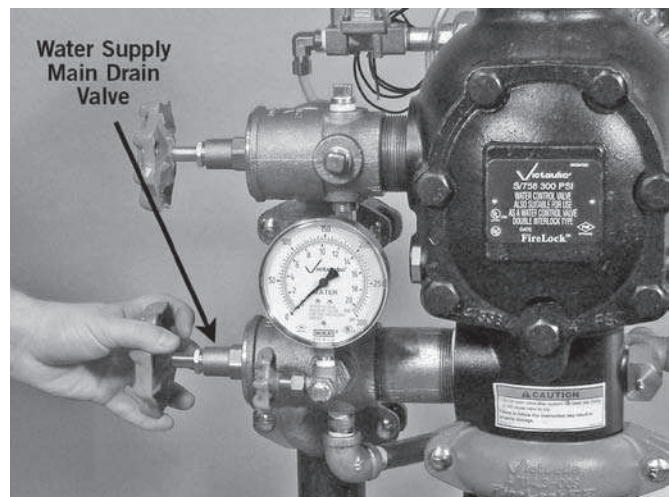

3. Open the water supply main drain valve fully to flush the water supply of any contaminants.

FireLock NXT™ Preaction Valve

SERIES 769

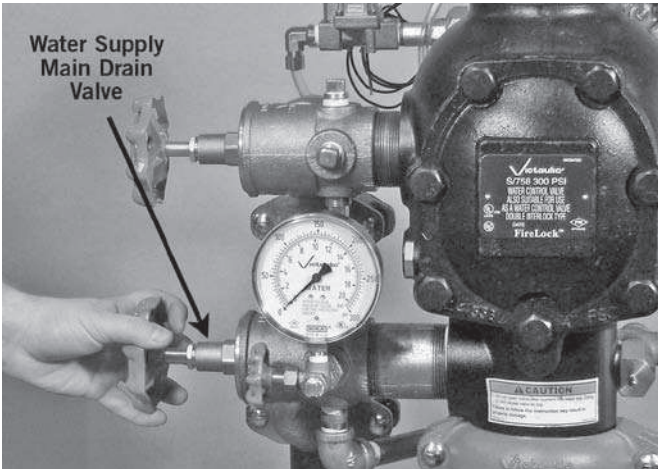

4. Close the water supply main drain valve.

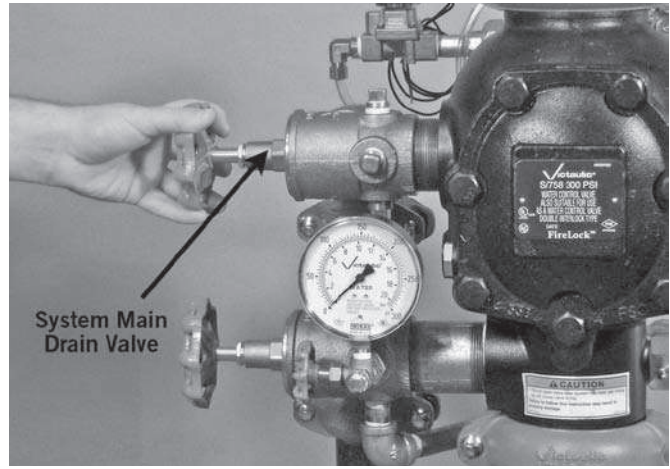

8. Close the system main drain valve.

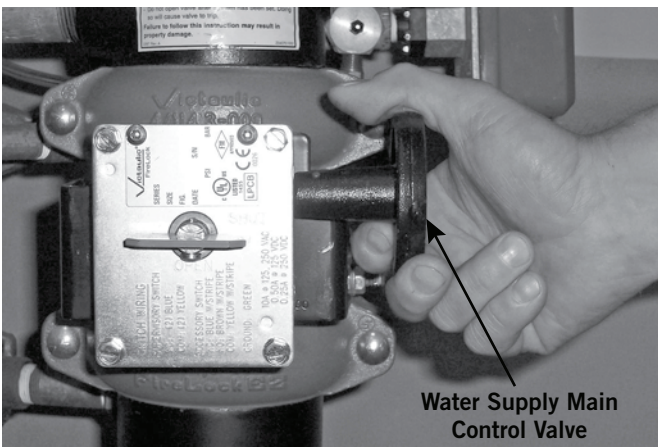

5. Close the water supply main control valve.

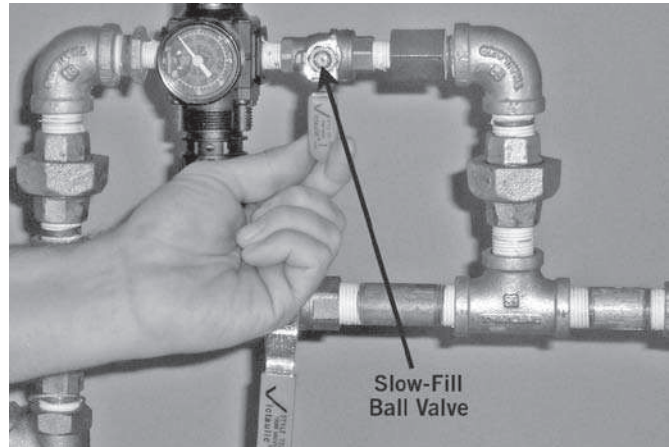

9. Close the slow-fill ball valve on the AMTA.

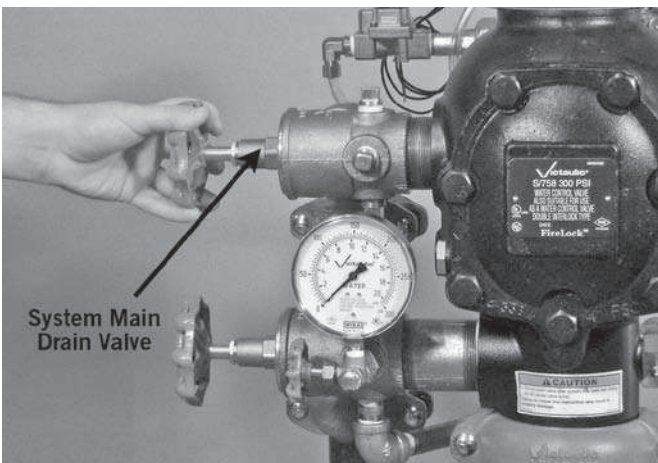

6. Partially open the system main drain valve slowly. Confirm that water is not flowing from the drain. **NOTE:** If water is flowing from the drain, the system may not have drained properly. In this case, follow all steps under the "Placing the System in Service" section.
 7. Record the system air pressure at which the low air alarm activates.

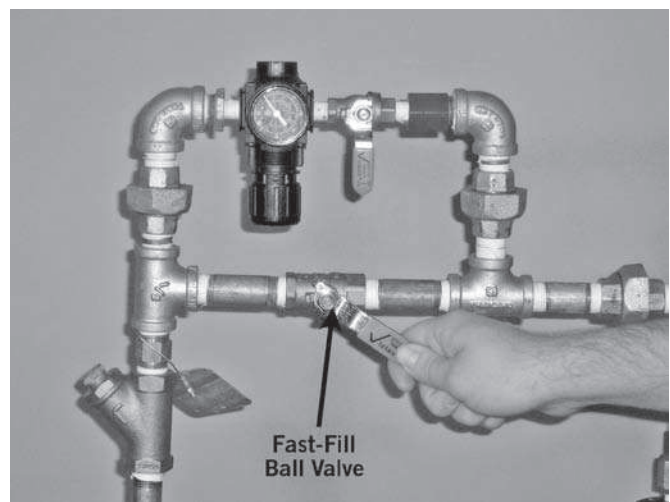

10. Open the fast-fill ball valve on the AMTA. Bring the pressure back up to the normal system pressure.

FireLock NXT™ Preaction Valve

SERIES 769

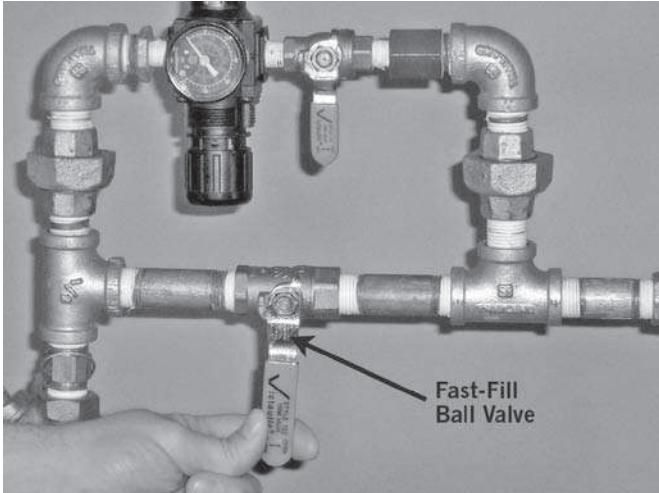

11. When the normal system air pressure is reached, close the fast-fill ball valve on the AMTA.

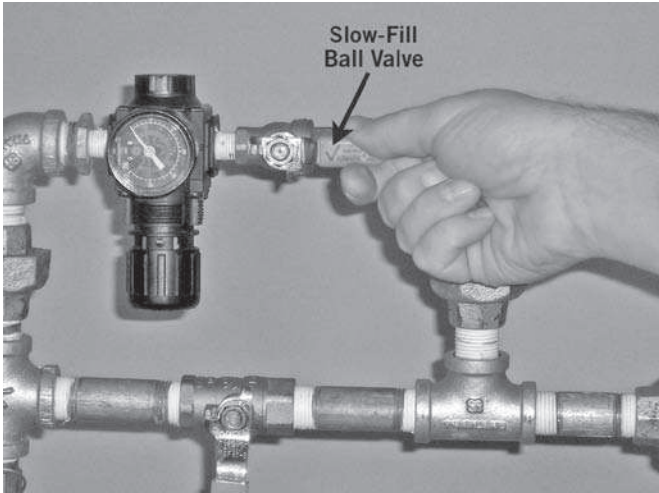

12. Open the slow-fill ball valve on the AMTA.

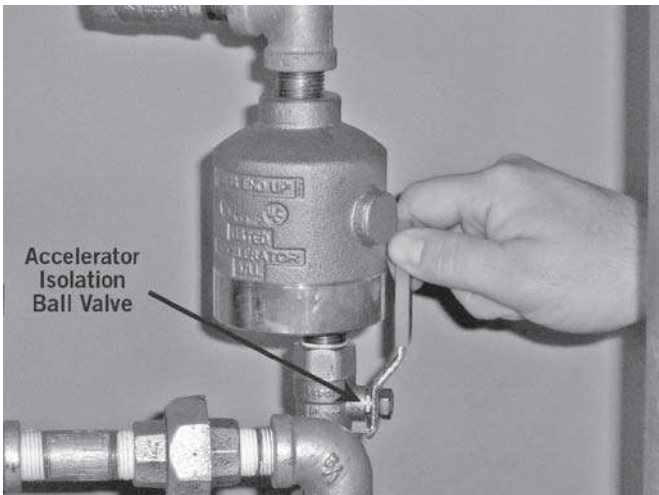

13. If a Series 746-LPA Dry Accelerator is installed, open the isolation ball valve.

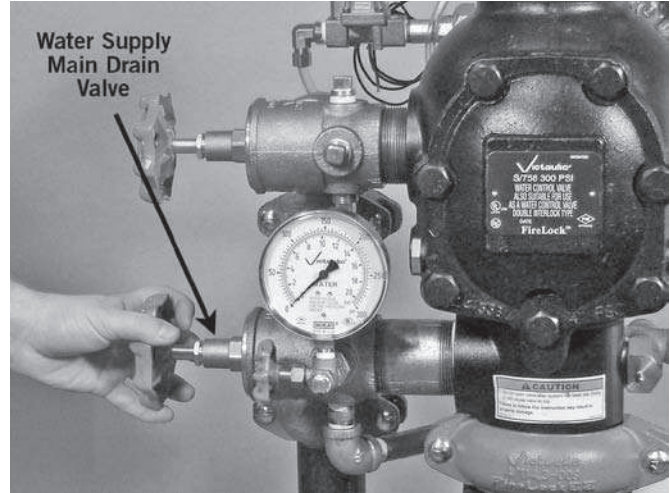

14. Open the water supply main drain valve.

⚠ CAUTION

- Take precautions when opening the water supply main control valve, since water will flow from all open system valves. Failure to follow this instruction could result in property damage.

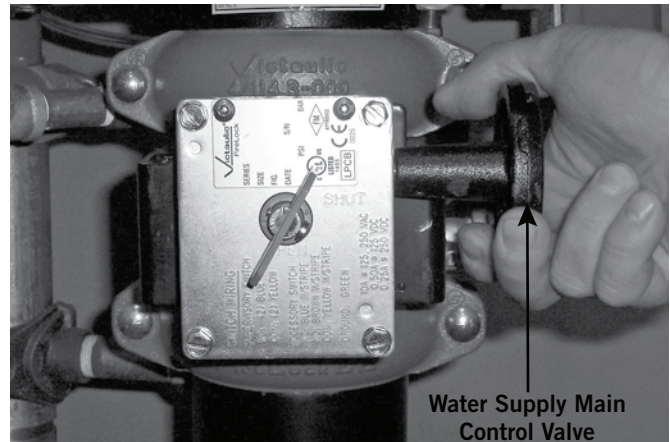

15. Open the water supply main control valve slowly until water flows steadily from the open water supply main drain valve.

FireLock NXT™ Preaction Valve

SERIES 769

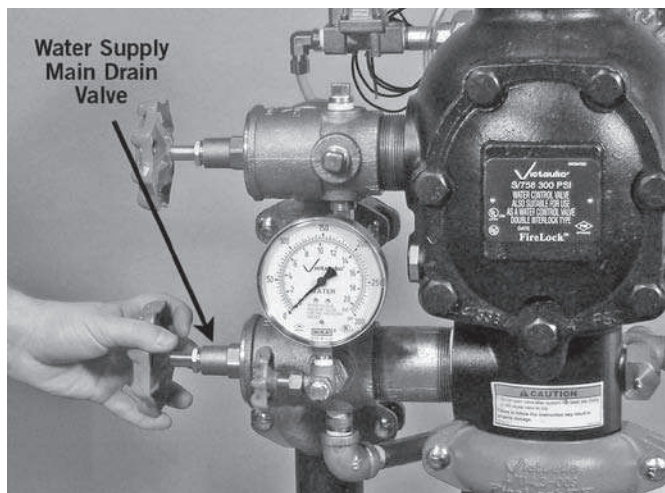

16. Close the water supply main drain valve when a steady flow of water occurs.

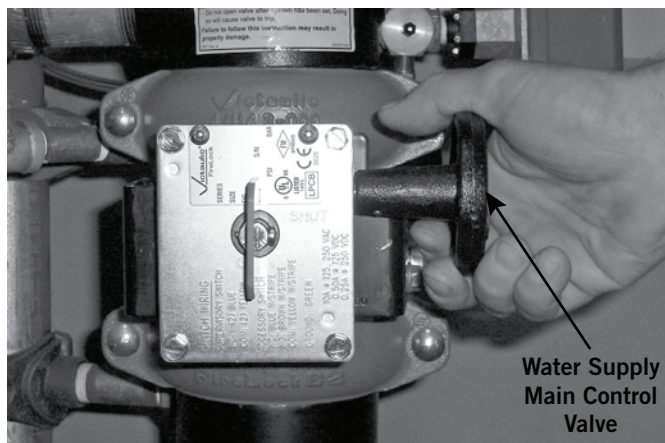

17. Open the water supply main control valve fully.
18. Confirm that all valves are in their normal operating positions (refer to the table below).

Valve	Normal Operating Position
Diaphragm-Charge-Line Ball Valve	Open
Alarm Test Ball Valve	Closed
Water Supply Main Control Valve	Open
Water Supply Main Drain Valve	Closed
System Main Drain Valve	Closed
Slow-Fill Ball Valve of the Victaulic AMTA (if applicable)	Open
Fast-Fill Ball Valve of the Victaulic AMTA (if applicable)	Closed
Isolation Ball Valve for Series 746-LPA Dry Accelerator (if applicable)	Open
¼-Turn Vent Ball Valve for Series 746-LPA Dry Accelerator (if applicable)	Closed

19. Notify the authority having jurisdiction, remote station alarm monitors, and those in the affected area that the valve is back in service.
20. Provide test results to the authority having jurisdiction, if required.

FireLock NXT™ Preaction Valve

SERIES 769

REQUIRED OPERATIONAL (TRIP) TESTS

PARTIAL OPERATIONAL (TRIP) TEST

⚠ WARNING

- The building owner or their representative is responsible for maintaining the fire protection system in proper operating condition.
- To ensure proper system operation, valves must be inspected in accordance with current NFPA-25 requirements or in accordance with the requirements of the local authority having jurisdiction (whichever is more stringent). Always refer to the instructions in this manual for additional inspection and testing requirements.
- The frequency of inspections must be increased in the presence of contaminated water supplies, corrosive/scaling water supplies, and corrosive atmospheres.
- Depressurize and drain the piping system before attempting to install, remove, adjust, or maintain any Victaulic products.

Failure to follow these instructions could cause system failure, resulting in death, serious personal injury, and property damage.

Partial operational (trip) tests are required to confirm proper valve operation; however, this test does not confirm full system operation. Victaulic recommends performing the partial operational (trip) test annually (at minimum). **NOTE:** The frequency of the partial operational (trip) test must be increased in the presence of contaminated water supplies, corrosive/scaling water supplies, and corrosive atmospheres. In addition, the authority having jurisdiction in the area may require partial operational (trip) tests on a more frequent basis. Verify these requirements by contacting the authority having jurisdiction in the affected area.

1. Notify the authority having jurisdiction, remote station alarm monitors, and those in the affected area that the partial operational (trip) test will be performed.
2. Record the water supply pressure and system air pressure.

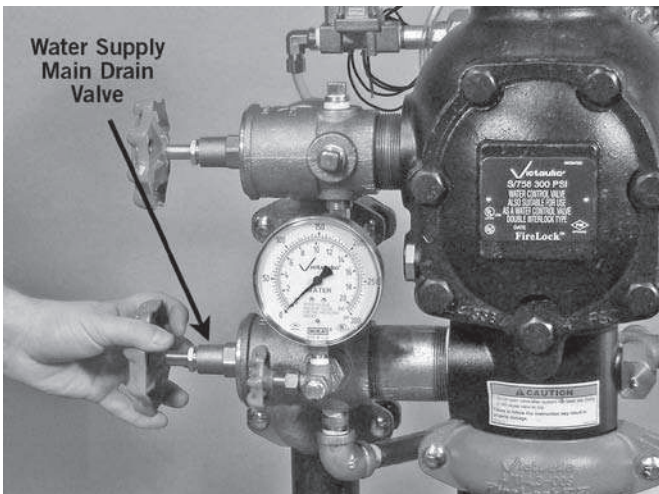

3. Open the water supply main drain valve fully to flush the water supply of any contaminants.

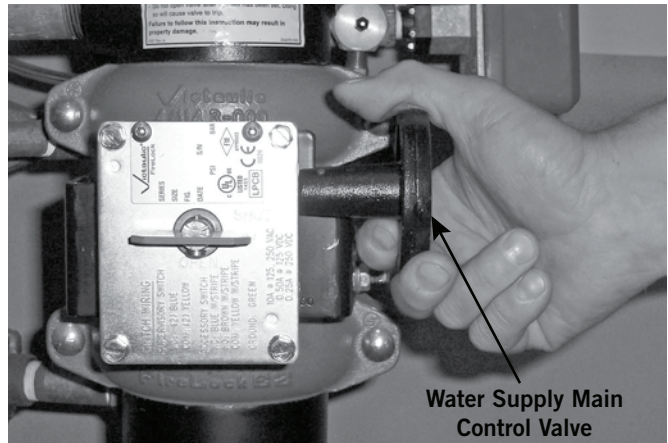

4. Close the water supply main control valve to the point where additional closure will not provide flow through the water supply main drain valve.

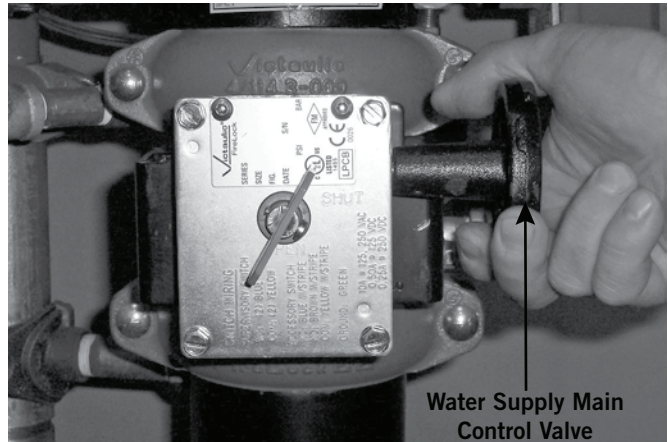

5. Open the water supply main control valve slowly until a small amount of water flows through the water supply main drain valve.

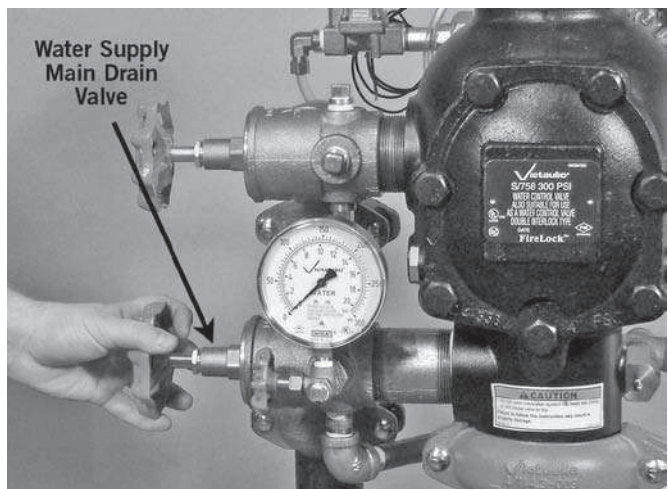

6. Close the water supply main drain valve.

FireLock NXT™ Preaction Valve

SERIES 769

7. Trip the valve by doing one of the following:
 - a. Energize the solenoid valve
 - b. Relieve the air pressure from the pilot line
 - c. Open the manual pull station
8. Confirm that the diaphragm charge line's pressure drops to zero and that water is flowing through the auto drain to the drip cup.

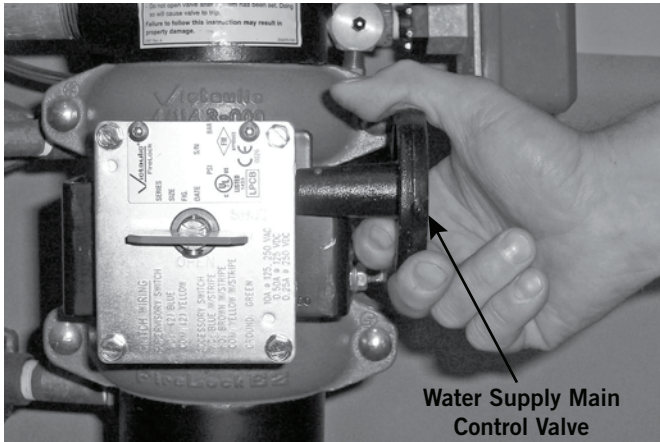

9. Close the water supply main control valve fully.

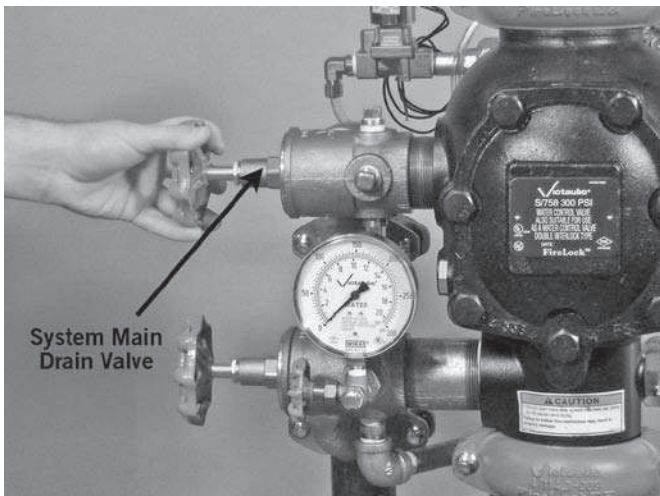

10. Close the remote system test valve (inspector's test connection) or the system main drain valve. **NOTE:** The system main drain valve is shown above.
11. **SHUT OFF THE AIR SUPPLY.**

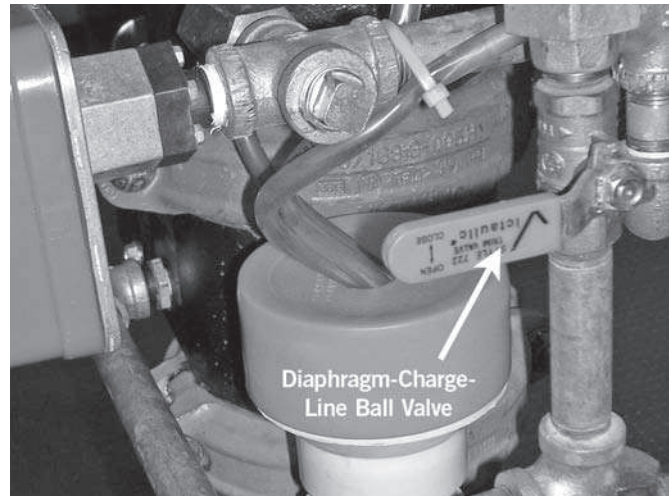

12. Close the diaphragm-charge-line ball valve.
13. Perform all steps in the "Placing the System in Service" section.

FireLock NXT™ Preaction Valve

SERIES 769

FULL OPERATIONAL (TRIP) TEST

WARNING

- The building owner or their representative is responsible for maintaining the fire protection system in proper operating condition.
- To ensure proper system operation, valves must be inspected in accordance with current NFPA-25 requirements or in accordance with the requirements of the local authority having jurisdiction (whichever is more stringent). Always refer to the instructions in this manual for additional inspection and testing requirements.
- The frequency of inspections must be increased in the presence of contaminated water supplies, corrosive/scaling water supplies, and corrosive atmospheres.
- Depressurize and drain the piping system before attempting to install, remove, adjust, or maintain any Victaulic products.

Failure to follow these instructions could cause system failure, resulting in death, serious personal injury, and property damage.

Victaulic recommends the full operational (trip) test every 3 years (at minimum). **NOTE:** The frequency of the full operational (trip) test must be increased in the presence of contaminated water supplies, corrosive/scaling water supplies, and corrosive atmospheres. This test allows a full flow of water into the sprinkler system; therefore, this test must be performed when there is no chance for freezing conditions. In addition, the authority having jurisdiction in the area may require full operational (trip) tests on a more frequent basis. Verify these requirements by contacting the authority having jurisdiction in the affected area.

1. Notify the authority having jurisdiction, remote station alarm monitors, and those in the affected area that the full operational (trip) test will be performed.
2. Record the water supply pressure and system air pressure.

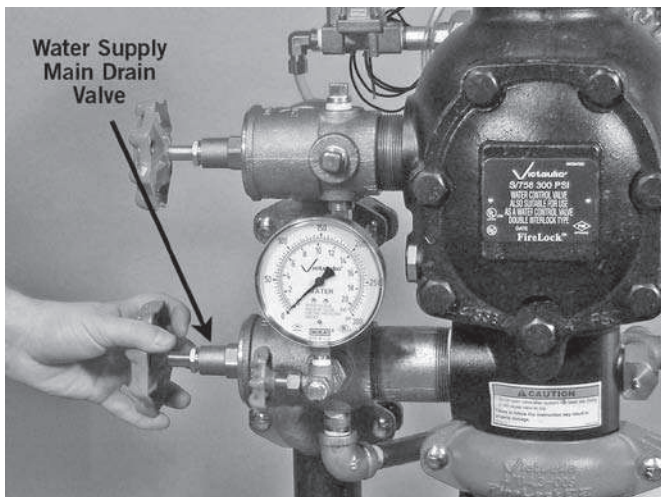

3. Open the water supply main drain valve fully to flush the water supply of any contaminants.

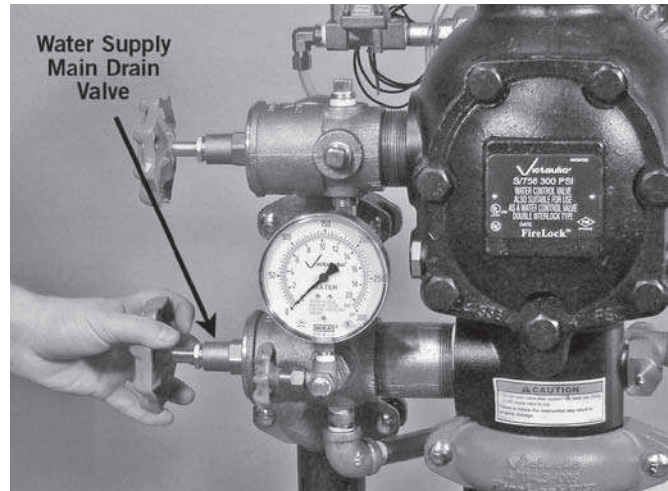

4. Close the water supply main drain valve.
5. Trip the valve by doing one of the following:
 - a. Energize the solenoid valve
 - b. Relieve the air pressure from the pilot line
 - c. Open the manual pull station
6. Record the following:
 - a. Time between opening the remote system test valve (inspector's test connection) to the operation of the preaction valve
 - b. System air pressure when the valve operated
 - c. Time from opening the remote system test valve (inspector's test connection) to when water flows from the test connection's outlet
 - d. All information required by the authority having jurisdiction
7. Confirm that all alarms operate properly.
8. Continue to run water until it is clear.

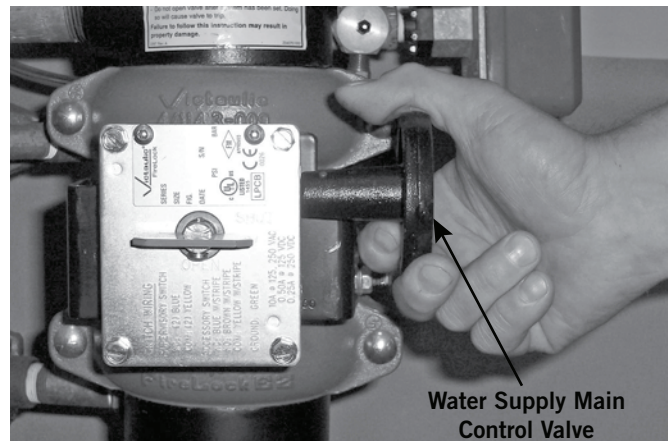

9. Close the water supply main control valve.

FireLock NXT™ Preaction Valve

SERIES 769

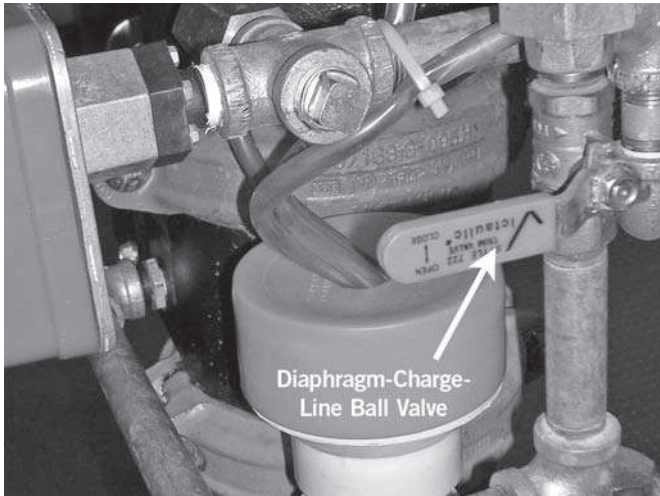

10. Close the diaphragm-charge-line ball valve.
11. **SHUT OFF THE AIR SUPPLY.**

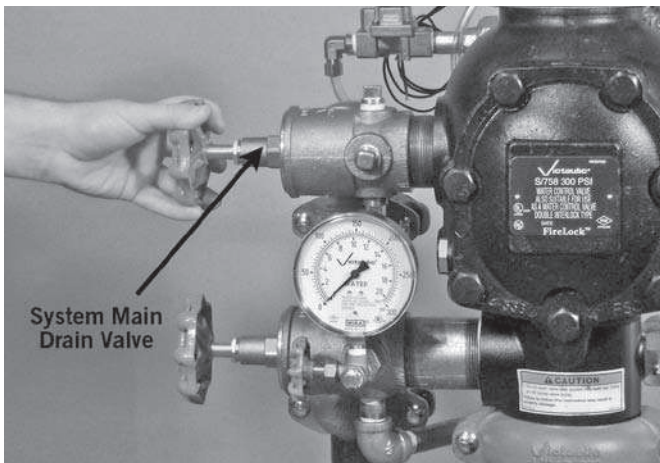

12. Open the system main drain valve to drain the system.
13. After the system is properly drained, close the remote system test valve (inspector's test connection).

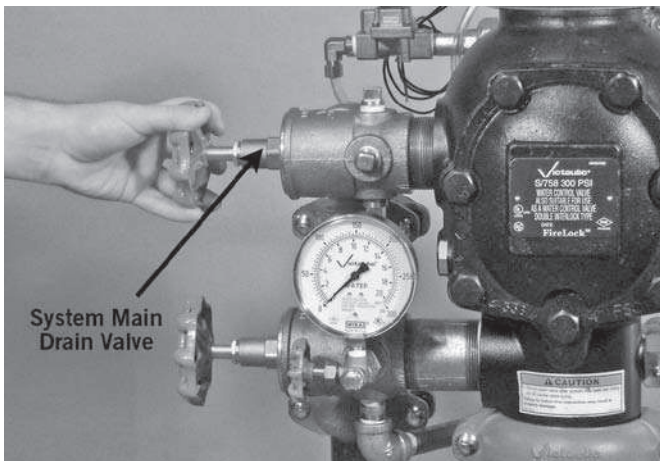

14. Close the system main drain valve.
15. Perform all steps in the “Placing the System in Service” section.

FireLock NXT™ Preaction Valve

SERIES 769

REQUIRED INTERNAL INSPECTION

Inspect internal components on a frequency required by the current NFPA-25 code. The authority having jurisdiction in the area may require these inspections on a more frequent basis. Verify these requirements by contacting the authority having jurisdiction in the affected area.

⚠ WARNING	
	<ul style="list-style-type: none"> Depressurize and drain the piping system before attempting to remove the cover plate from the valve. <p>Failure to follow this instruction could result in serious personal injury and/or property damage.</p>

⚠ CAUTION	
	<ul style="list-style-type: none"> Any activities that require taking the valve out of service may eliminate the fire protection provided. Before servicing or testing the system, notify the authority having jurisdiction. Consideration of a fire patrol should be given in the affected areas. <p>Failure to follow these instructions could result in serious personal injury and/or property damage.</p>

1. Notify the authority having jurisdiction, remote station alarm monitors, and those in the affected area that the system is being taken out of service.

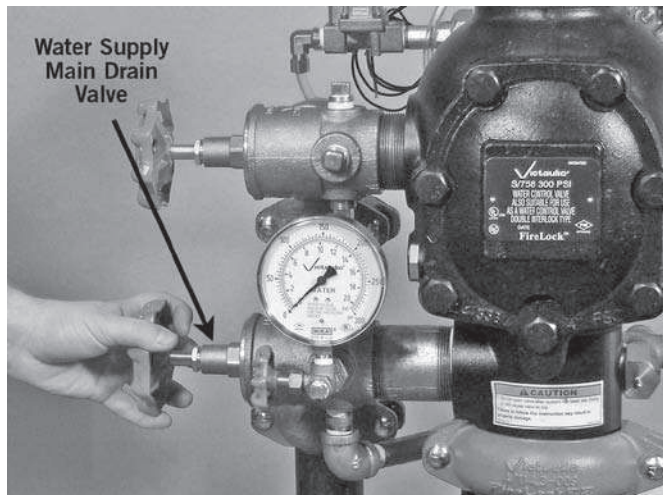

2. Open the water supply main drain valve fully to flush the water supply of any contaminants.

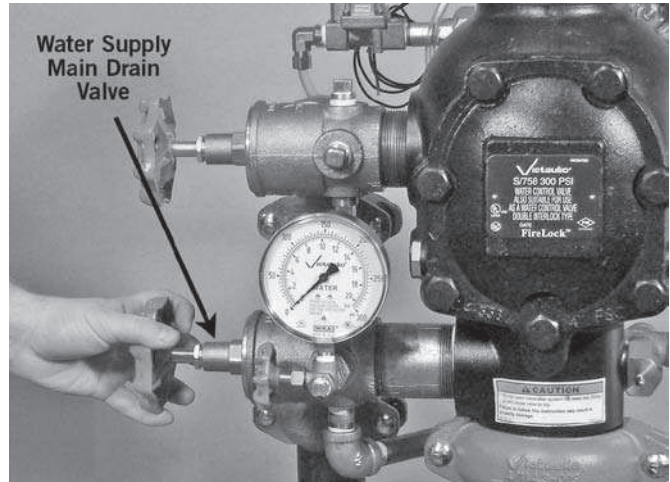

3. Close the water supply main drain valve.

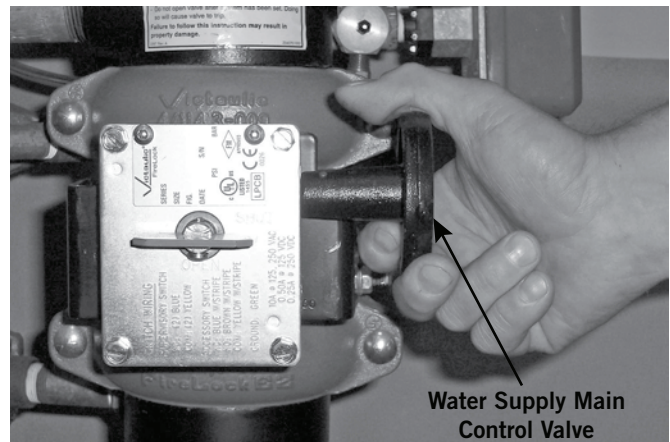

4. Close the water supply main control valve to take the system out of service.

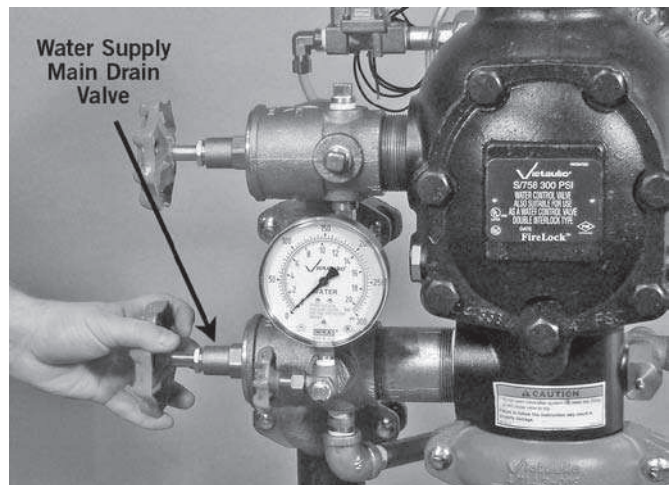

5. Open the water supply main drain valve.
6. Confirm that water is not flowing from the water supply main drain valve.

FireLock NXT™ Preaction Valve

SERIES 769

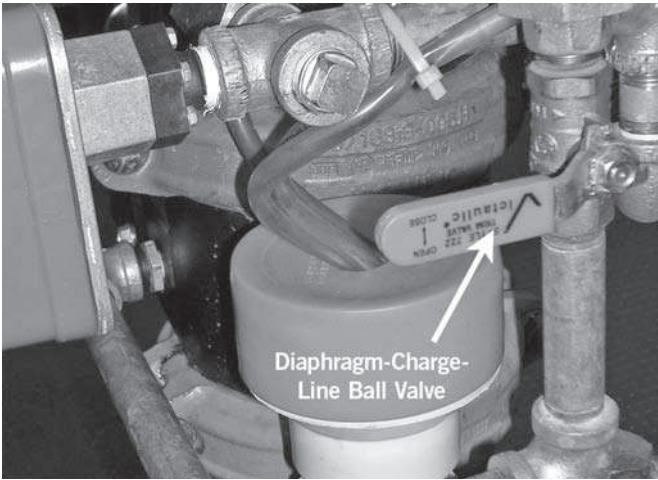

7. Close the diaphragm-charge-line ball valve.

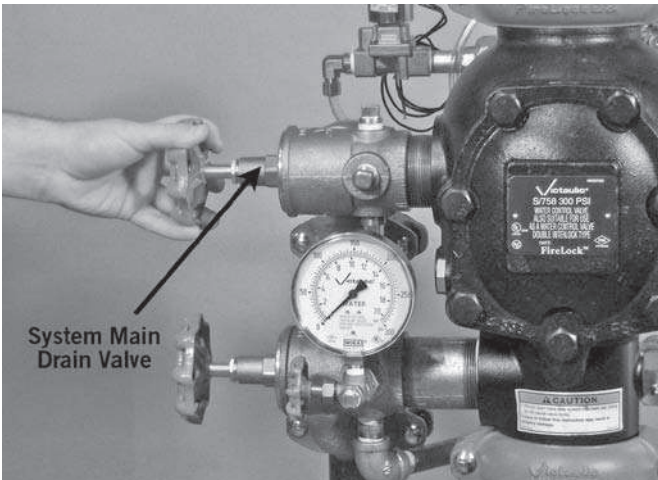

8. Open the system main drain valve to drain any water that has accumulated and to release system air pressure.

NOTE: If the system has operated, open the remote system test valve (inspector's test connection) and any auxiliary drain valves.

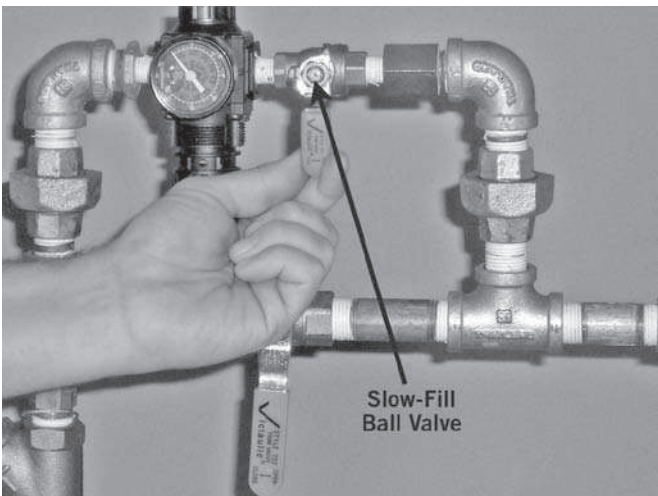

9. Close the slow-fill ball valve on the AMTA.

WARNING



- Make sure the valve is depressurized and drained completely before the cover plate bolts are removed.



The cover plate could blow off if the cover plate bolts are removed while the valve is pressurized, resulting in serious personal injury and/or property damage.

10. OPEN THE MANUAL PULL STATION.

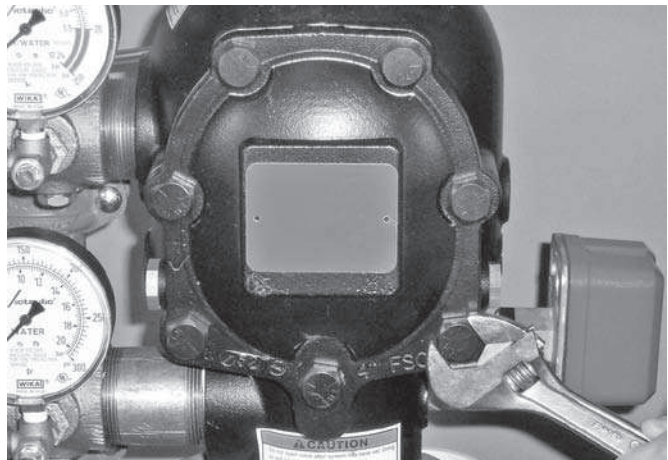

11. After all pressure is released from the system, loosen the cover plate bolts slowly. **NOTE:** DO NOT remove any cover plate bolts until all cover plate bolts are loosened.

11a. Remove all cover plate bolts, along with the cover plate and cover plate gasket. **NOTE:** The 1 ½-inch/48.3-mm and 2-inch/60.3-mm valve sizes contain washers under the heads of the cover plate bolts. Keep these washers for re-installation.

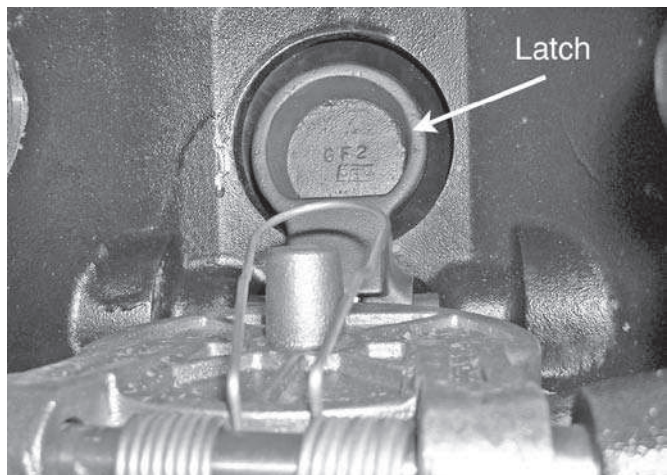

12. Push the latch back (toward the diaphragm).

FireLock NXT™ Preaction Valve

SERIES 769

CAUTION

- **DO NOT** use solvents or abrasives on or near the valve body seat ring.

Failure to follow this instruction could prevent the clapper from sealing, resulting in improper valve operation and/or valve leakage.

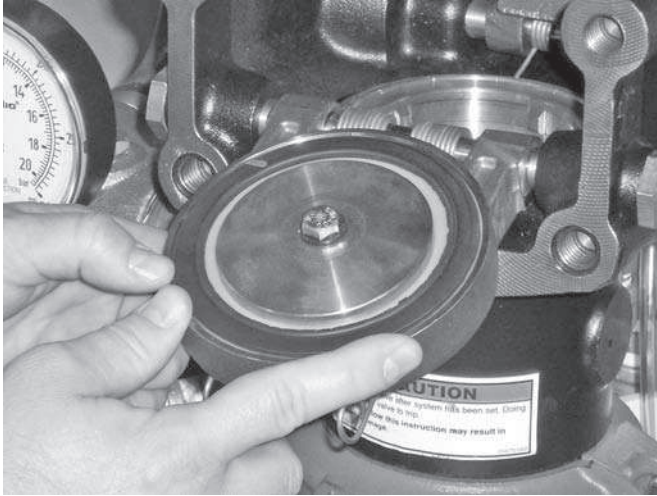

13. Rotate the clapper out of the valve body. Inspect the clapper seal and seal-retaining ring. Wipe away any contaminants, dirt, and mineral deposits. Clean out any holes that are plugged in the valve-body seat ring. **DO NOT USE SOLVENTS OR ABRASIVES.**
14. While the clapper is rotated out of the valve body, pull the latch forward to inspect the diaphragm. If the diaphragm shows any signs of wear or damage, replace it with a new, Victaulic-supplied diaphragm. Refer to the "Removing and Replacing the Diaphragm Assembly" section.

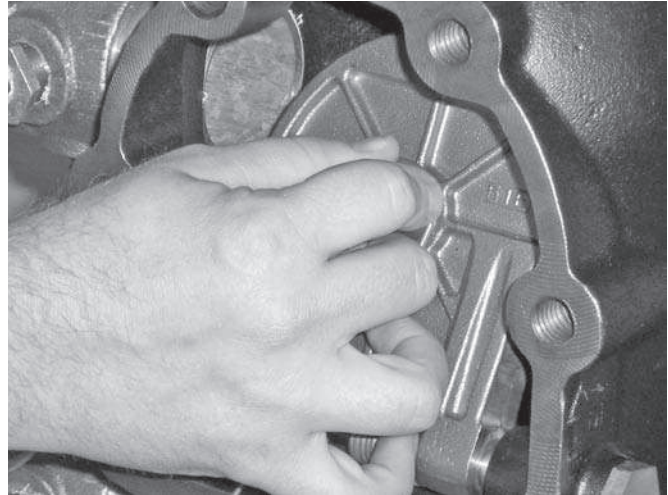

15. Inspect the clapper for freedom of movement and physical damage. Replace any damaged or worn parts by following the applicable instructions in the "Maintenance" section.
16. Re-install the cover plate by following the "Installing the Cover Plate Gasket and Cover Plate" section.
17. Place the system back in service by following the "Placing the System in Service" section.

FireLock NXT™ Preaction Valve

SERIES 769

MAINTENANCE

The following sections instruct on how to remove and replace internal valve components. Care must be taken to avoid damage to parts during removal and installation.

⚠ WARNING	
	<ul style="list-style-type: none"> • Depressurize and drain the piping system before attempting to remove the cover plate from the valve. <p>Failure to follow this instruction could result in serious personal injury and/or property damage.</p>

⚠ CAUTION	
	<ul style="list-style-type: none"> • Any activities that require taking the valve out of service may eliminate the fire protection provided. • Before servicing or testing the system, notify the authority having jurisdiction. • Consideration of a fire patrol should be given in the affected areas. <p>Failure to follow these instructions could result in serious personal injury and/or property damage.</p>

REMOVING AND REPLACING THE CLAPPER SEAL

1. Perform steps 1 – 12 of the “Required Internal Inspection” section.



2. Remove the seal assembly bolt/bolt seal from the clapper seal.

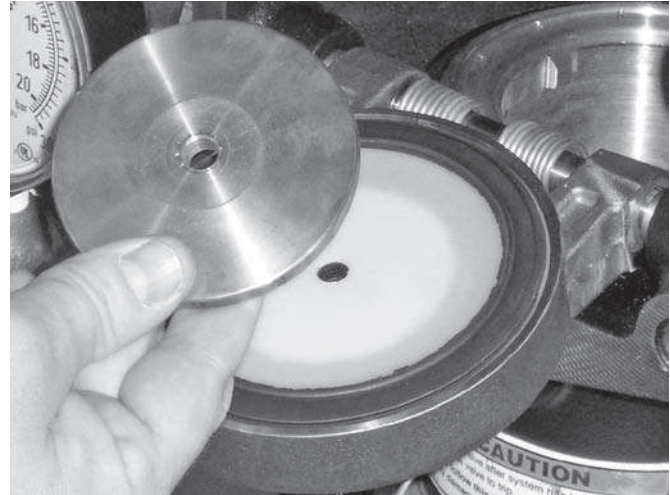

3. Remove the seal-retaining ring.

⚠ CAUTION	
<ul style="list-style-type: none"> • DO NOT pry the seal washer out of the clapper seal from the inner hole. <p>Failure to follow this instruction could damage the seal washer, resulting in improper clapper sealing and valve leakage.</p>	

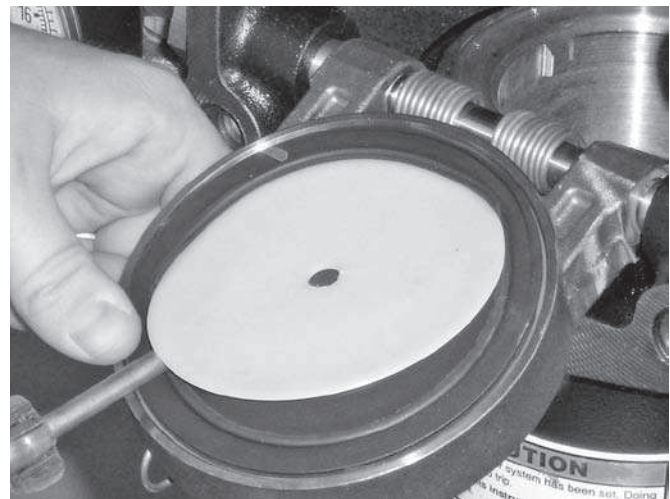

4. Pry the edge of the seal washer from inside the clapper seal, as shown above. **DO NOT PRY THE SEAL WASHER OUT FROM THE INNER HOLE.**
5. Remove the seal washer from the clapper seal. Dry up any moisture that is under the seal washer and on the clapper seal.

⚠ CAUTION	
<ul style="list-style-type: none"> • Use only Victaulic-supplied replacement parts. <p>Failure to follow this instruction could cause improper valve operation, resulting in property damage.</p>	

FireLock NXT™ Preaction Valve

SERIES 769

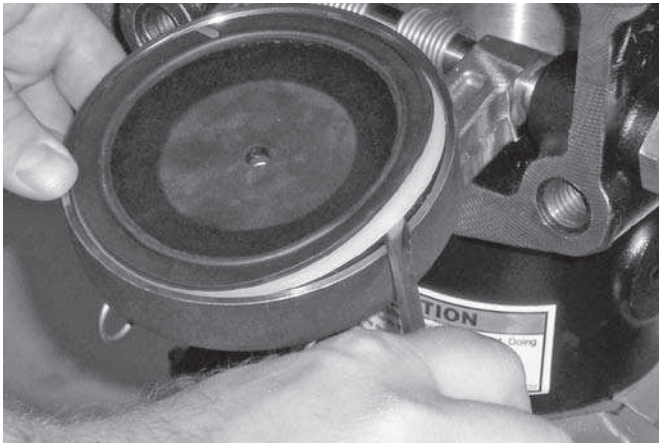

6. Pry the clapper seal, along with the seal ring, out of the clapper. Inspect the clapper seal. If the clapper seal is torn or worn, replace it with a new, Victaulic-supplied clapper seal. If replacing the clapper seal assembly with a new assembly, skip to step 7.

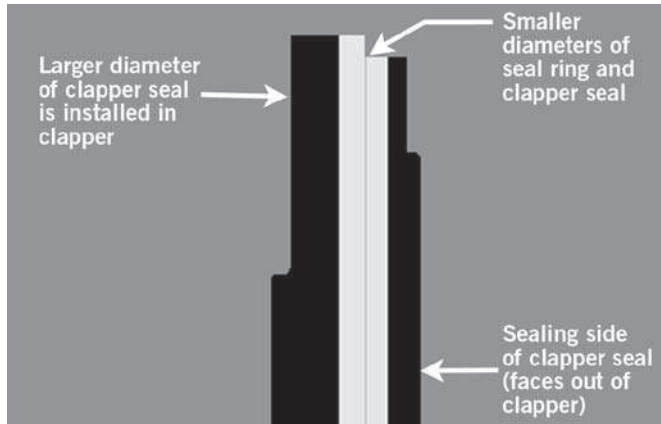

- 6a. **If using the same clapper seal assembly and the seal ring was removed from the clapper seal in the previous step:** Re-insert the seal ring carefully underneath the outer lip of the clapper seal. Make sure the smaller diameter of the seal ring is toward the sealing surface of the clapper seal.

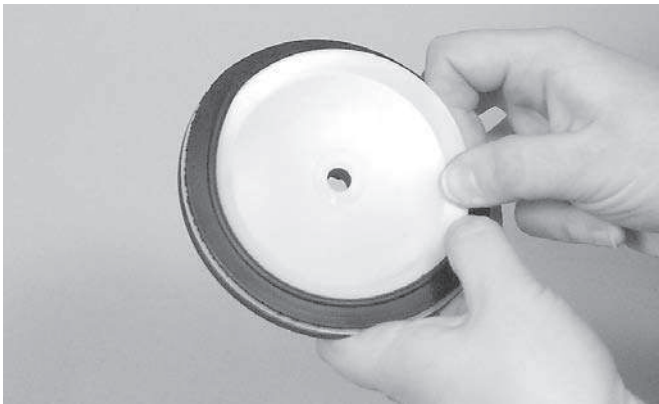

7. Insert the seal washer carefully underneath the sealing lip of the gasket.
8. Remove any contaminants, dirt, and mineral deposits from the clapper.



9. Install the clapper seal into the clapper carefully. Make sure the seal ring snaps into the clapper completely.



10. Place the seal-retaining ring onto the seal washer of the clapper seal. Install the seal-assembly bolt/bolt seal through the seal-retaining ring and clapper.

FireLock NXT™ Preaction Valve

SERIES 769

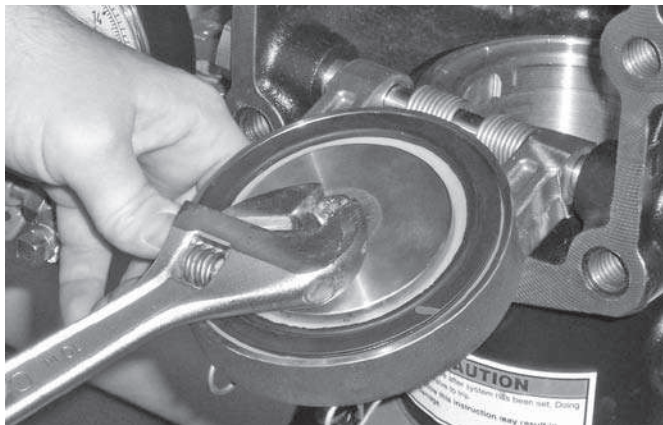

11. Tighten the seal-assembly bolt/bolt seal to the torque value, listed in the table below, to ensure a proper seal.

REQUIRED SEAL-ASSEMBLY BOLT/BOLT SEAL TORQUES

Size		Torque
Nominal Size inches	Actual Outside Diameter inches mm	inch-lbs N•m
1 ½	1.900 48.3	40 5
2	2.375 60.3	40 5
2 ½	2.875 73.0	90 10
76.1 mm	3.000 76.1	90 10
3	3.500 88.9	90 10
4	4.500 114.3	110 12
165.1 mm	6.500 165.1	160 18
6	6.625 168.3	160 18
8	8.625 219.1	160 18

12. Replace the cover plate by following the “Installing the Cover Plate Gasket and Cover Plate” section.
13. Place the system back in service by following the “Placing the System in Service” section.

REMOVING AND REPLACING THE CLAPPER ASSEMBLY

1. Perform steps 1 – 12 of the “Required Internal Inspection” section.

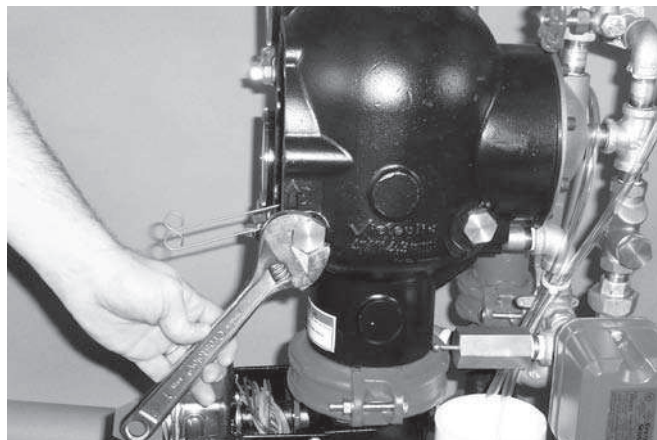

2. Remove the clapper shaft bushings from the valve body.

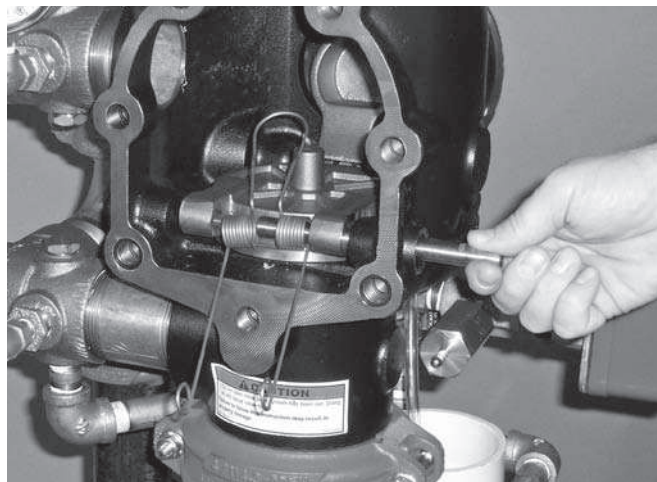

3. Remove the clapper shaft. **NOTE:** As the shaft is being removed, the clapper spring will drop out of position. Keep the clapper spring for re-installation.

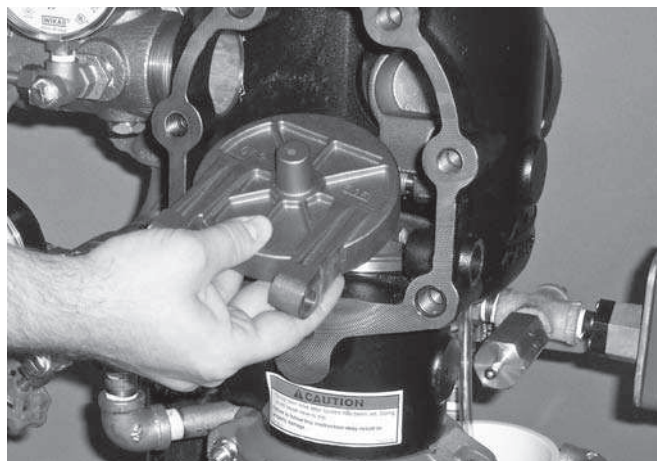

4. Remove the clapper from the valve body.

FireLock NXT™ Preaction Valve

SERIES 769

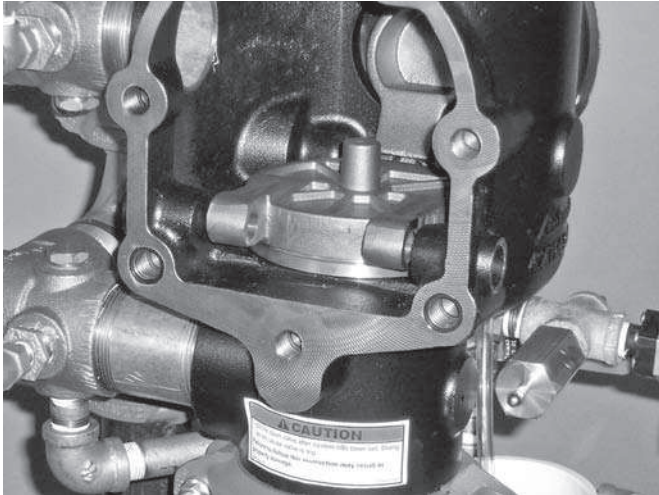

5. Place the new clapper assembly onto the valve-body seat ring. Make sure the holes in the clapper arms align with the holes in the valve body.

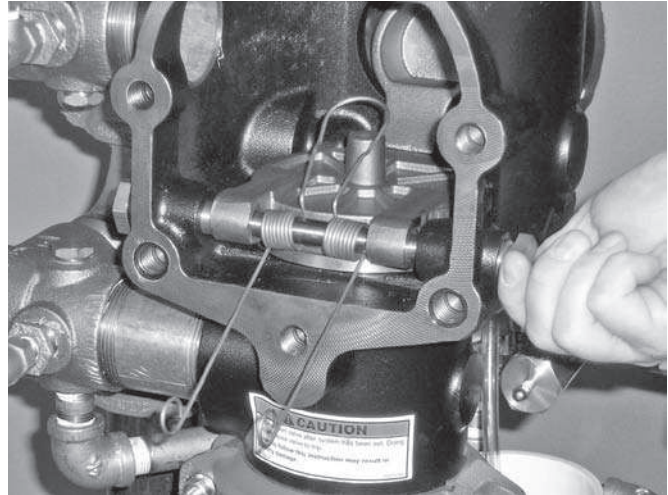

9. Apply thread sealant to the clapper shaft bushings. Install the clapper shaft bushings into the valve body until hand-tight.
10. Tighten the clapper shaft bushings until metal-to-metal contact occurs with the valve body.

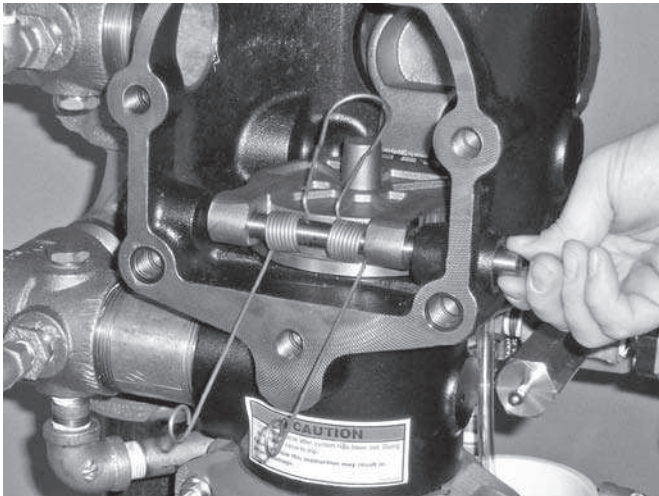

6. Insert the clapper shaft halfway into the valve body.
7. Install the clapper spring onto the clapper shaft. Make sure the loop of the clapper spring is facing toward the clapper, as shown above.
8. Finish inserting the clapper shaft through the clapper arm and valve body.



11. Check the clapper for freedom of movement.
12. Replace the cover plate by following the “Installing the Cover Plate Gasket and Cover Plate” section.
13. Place the system back in service by following the “Placing the System in Service” section.

FireLock NXT™ Preaction Valve

SERIES 769

INSTALLING THE COVER PLATE GASKET AND COVER PLATE

CAUTION

- Use only Victaulic-supplied replacement parts.

Failure to follow this instruction could cause improper valve operation, resulting in property damage.

- Verify that the cover plate gasket is in good condition. If the gasket is torn or worn, replace it with a new, Victaulic-supplied gasket.

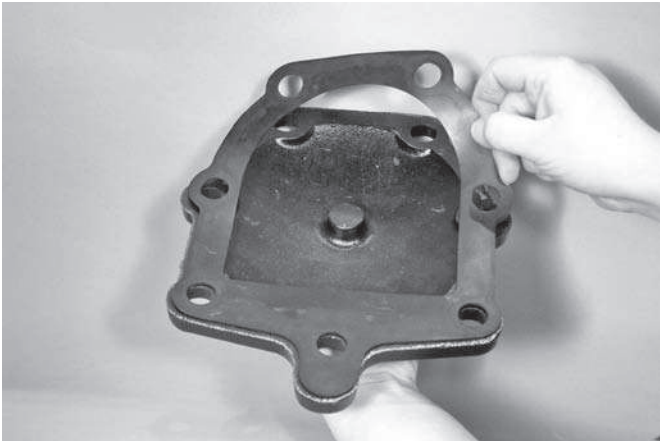

- Align the holes of the cover plate gasket with the holes in the cover plate.



- Insert one cover plate bolt through the cover plate and cover plate gasket to ease alignment. **NOTE:** For 1 1/2-inch/48.3-mm and 2-inch/60.3-mm valve sizes, a washer must be re-installed under the head of each cover plate bolt.

CAUTION

- DO NOT over-tighten the cover plate bolts.

Failure to follow this instruction could cause damage to the cover plate gasket, resulting in valve leakage.

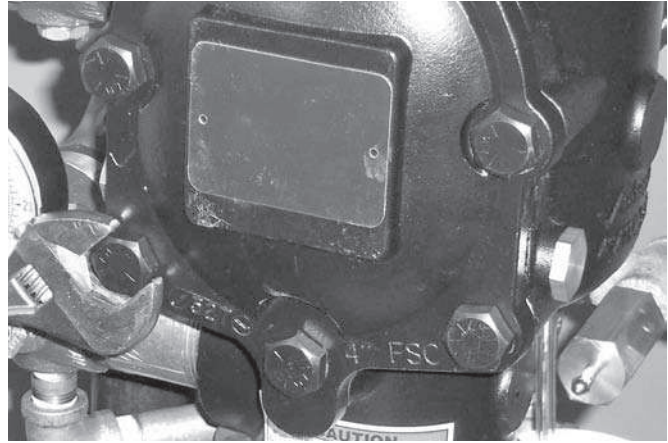

- Align the cover plate/cover plate gasket to the valve. Make sure the clapper spring's arms are rotated to their installed position. Tighten all cover plate bolts into the cover plate/valve body.
- Torque all cover plate bolts in an even, crossing pattern. Refer to the "Required Cover Plate Bolt Torques" table below for the required torque values. DO NOT over-tighten the cover plate bolts.

REQUIRED COVER PLATE BOLT TORQUES

Size		Torque
Nominal Size inches	Actual Outside Diameter inches mm	ft-lbs N•m
1 1/2	1.900	30
	48.3	41
2	2.375	30
	60.3	41
2 1/2	2.875	60
	73.0	81
76.1 mm	3.000	60
	76.1	81
3	3.500	60
	88.9	81
4	4.500	100
	114.3	136
165.1 mm	6.500	115
	165.1	156
6	6.625	115
	168.3	156
8	8.625	100
	219.1	136

- Place the system back in service by following the "Placing the System in Service" section.

FireLock NXT™ Preaction Valve

SERIES 769

REMOVING AND REPLACING THE DIAPHRAGM ASSEMBLY

1. Remove the system from service by following steps 1 – 11 of the “Required Internal Inspection” section.
2. Break the unions that connect the trim to the diaphragm cover. Refer to the applicable trim drawing for details.

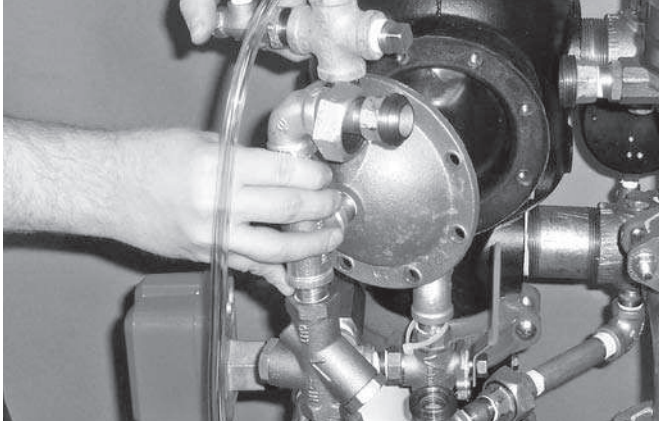

3. Remove the cap screws from the diaphragm cover, and pull the diaphragm cover/trim off the valve.

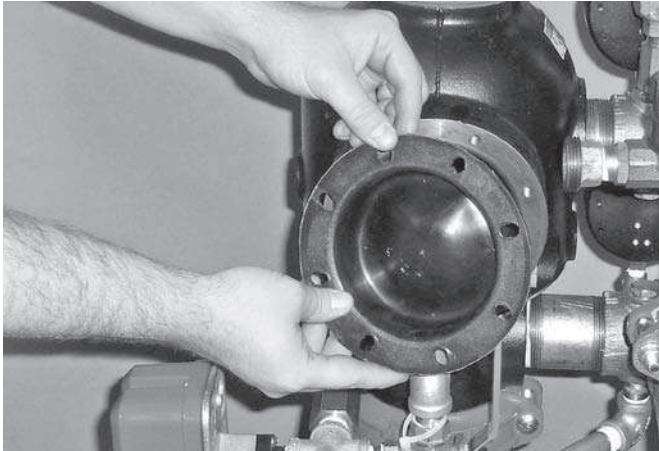

4. Remove the diaphragm from the valve body.



5. Clean the back of the valve body to remove any debris that may interfere with proper diaphragm seating.

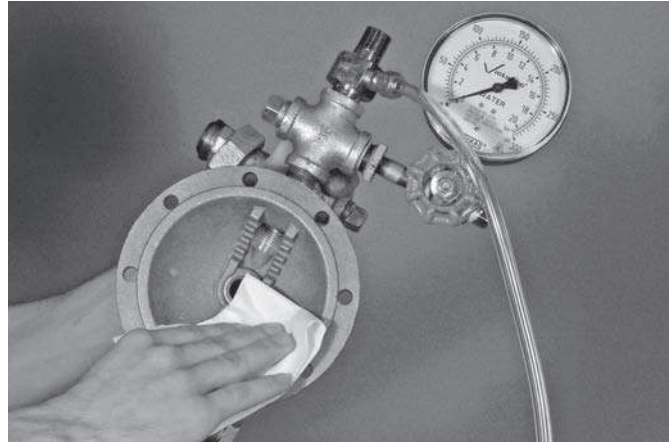

- 5a. Clean the inside of the diaphragm cover to remove any foreign material.

CAUTION

- Use caution when installing a new diaphragm into the valve body.

Failure to follow this instruction could cause damage to the diaphragm, resulting in improper valve operation and valve leakage.

6. Replace the diaphragm with a new, Victaulic-supplied diaphragm. Align the holes in the diaphragm with the holes in the valve body. Be careful not to damage the diaphragm during installation.

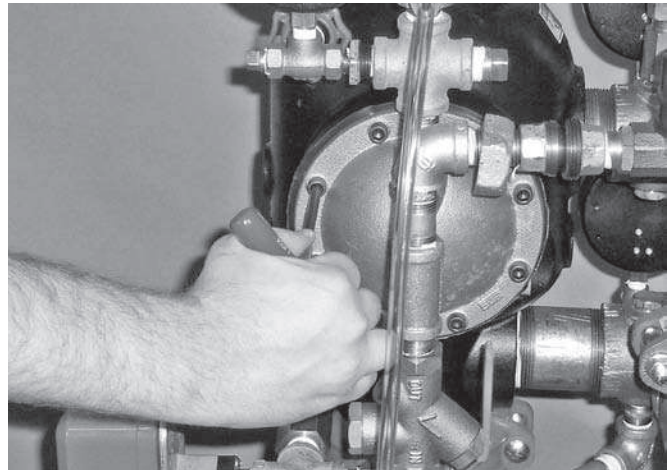

7. Align the holes of the diaphragm cover with the holes in the diaphragm/valve body. Tighten all cap screws into the diaphragm cover/valve body.
8. Re-attach the trim at the unions that were loosened in step 2. Refer to the applicable trim drawing for details. **MAKE SURE ALL UNIONS THAT WERE LOOSENED TO PERMIT ACCESS TO THE DIAPHRAGM COVER ARE RE-TIGHTENED BEFORE ATTEMPTING TO PLACE THE SYSTEM BACK IN SERVICE.**
9. Place the system back in service by following the “Placing the System in Service” section.

FireLock NXT™ Preaction Valve

SERIES 769

REPLACING THE STRAINER SCREEN FOR SERIES 776 LOW-PRESSURE ACTUATORS

1. Remove the system from service by following steps 1 – 11 of the “Required Internal Inspection” section.
2. Remove the Series 776 Low-Pressure Actuator from the trim. Refer to the applicable trim drawing for details.

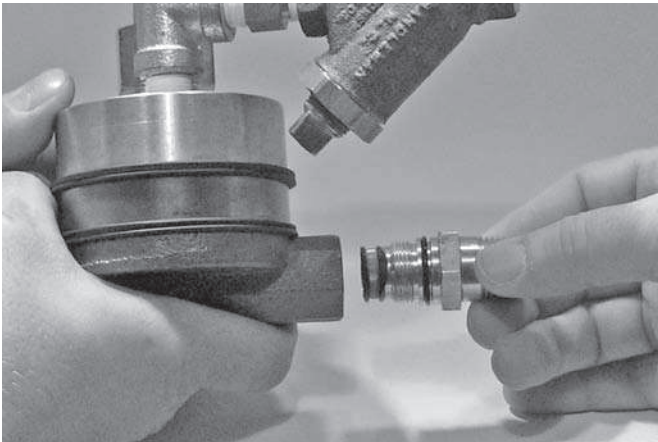

3. Remove the strainer assembly from the Series 776 Low-Pressure Actuator, as shown above. Discard the strainer screen only.

CAUTION

- **DO NOT re-use strainer screens. After removal, the old strainer screen must be replaced with a new, Victaulic-supplied screen.**

Failure to follow this instruction could cause improper valve operation, resulting in property damage.

4. Use only a new, Victaulic-supplied strainer screen. Insert the strainer screen into the strainer assembly.
5. Install the strainer assembly into the Series 776 Low-Pressure Actuator carefully. Avoid damage to the o-ring seals.
6. Re-install the Series 776 Low-Pressure Actuator into the trim. Refer to the applicable trim drawing for details.
7. Place the system back in service by following the “Placing the System in Service” section.

FireLock NXT™ Preaction Valve

SERIES 769

TROUBLESHOOTING – SERIES 776 LOW-PRESSURE ACTUATOR

Problem	Possible Cause	Solution
When the Auto Vent Sleeve of the Series 776 Low-Pressure Actuator is pulled up, the screw does not stay set in the “UP” position.	The Series 776 Low-Pressure Actuator is not receiving enough air.	Increase the air pressure going into the Series 776 Low-Pressure Actuator.
	The Series 776 Low-Pressure Actuator has a broken seal.	If the above procedure does not work, contact Victaulic.
Water is leaking through the Series 776 Low-Pressure Actuator.	The air chamber of the Series 776 Low-Pressure Actuator is not set.	Make sure the vent seal of the Series 776 Low-Pressure Actuator is in the set position and the air chamber is pressurized.
	The strainer on the Series 776 Low-Pressure Actuator is clogged.	Replace the strainer screen of the Series 776 Low-Pressure Actuator. Refer to the “Replacing the Strainer Screen for Series 776 Low-Pressure Actuators” section.
	The Series 776 Low-Pressure Actuator has a ripped diaphragm.	If water still leaks through the Series 776 after performing the above procedures, contact Victaulic.
No water is passing through the Series 776 Low-Pressure Actuator.	The strainer on the diaphragm charge line is clogged.	Disassemble and clean the diaphragm charge line strainer. Refer to the applicable trim drawing for details.

TROUBLESHOOTING – SERIES 753-E SOLENOID VALVE

Problem	Possible Cause	Solution
No water is passing through the Series 753-E Solenoid Valve.	The strainer on the diaphragm charge line is clogged.	Disassemble and clean the diaphragm charge line strainer. Refer to the applicable trim drawing for details.
The Series 776 Low Pressure Actuator does not open.	No power is going to the solenoid.	Check all electrical connections to make sure power is being supplied to the solenoid.

TROUBLESHOOTING – SERIES 746-LPA DRY ACCELERATOR

Problem	Possible Cause	Solution
The valve operates without sprinkler activation.	There is a loss of air pressure in the lower inlet chamber of the Series 746-LPA Dry Accelerator.	Check for air loss at the lower chamber seal. If a leak is present, turn the adjustment nut counterclockwise to seal.
		Check for any leaks in the system and trim. Confirm that the AMTA is operating properly.
The Series 746-LPA Dry Accelerator does not operate within a 5-psi/34-kPa/0.3-Bar pressure drop in system air pressure.	There is a loss of air pressure in the upper air chamber of the Series 746-LPA Dry Accelerator.	Apply soapy water to all joints around the Series 746-LPA Dry Accelerator to check for leaks. Repair any leaks and re-test.
	The air decay rate of the system is too slow.	Make sure there are no restrictions in the remote system test valve (inspector’s test connection). If the above procedures do not work, contact Victaulic.
The Series 746-LPA Dry Accelerator does not set up properly (cannot get pressure on the upper gauge, and the button pops up immediately when pressure is introduced).	The Series 746-LPA Dry Accelerator is installed upside-down.	Remove the Series 746-LPA Dry Accelerator from the trim, and turn the unit around so that the vent seal “button” is facing down (toward the Series 776 Low-Pressure Actuator).

FireLock NXT™ Preaction Valve

SERIES 769

TROUBLESHOOTING – SYSTEM

Problem	Possible Cause	Solution
The valve operates without sprinkler activation.	There is a loss of air pressure in the system or trim.	Check for any leaks in the system and trim. Confirm that the AMTA is operating properly. Consider installing a low-air supervisory switch.
	The pressure switch on the air compressor is set too low, or the compressor is not operating properly.	Increase the "ON" setting of the air compressor's pressure switch, and check the air compressor for proper operation.
Water is leaking from the drip check located in the alarm line.	Water is getting past the clapper seal and into the intermediate chamber of the valve.	Check the clapper seal and valve body seat ring for physical damage and foreign material.
	Water is under the clapper seal.	Inspect the clapper seal to make sure no water is under the seal. If water is present, remove and replace the seal. Refer to the "Removing and Replacing the Clapper Seal" section.
Air is leaking from the drip check located in the alarm line.	Air is getting past the clapper seal and into the intermediate chamber of the valve.	Check the clapper seal and valve body seat ring for physical damage and foreign material.
	Water is under the clapper seal.	Inspect the clapper seal to make sure no water is under the seal. If water is present, remove and replace the seal. Refer to the "Removing and Replacing the Clapper Seal" section.
The clapper will not latch closed.	There is no water pressure on the diaphragm.	Check the water pressure in the diaphragm charge line. Make sure the restrictor in the diaphragm charge line is clean.
	The Auto Drain is not set.	Set the Auto Drain by pulling up on the Auto Drain Sleeve.
Water is leaking from the diaphragm assembly.	The diaphragm is damaged.	Contact Victaulic.
Air is leaking from the diaphragm assembly.	The diaphragm is damaged.	Contact Victaulic.

FireLock NXT™ Preaction Valve

SERIES 769

NON-INTERLOCKED, PNEUMATIC RELEASE WITH SERIES 776 LOW-PRESSURE ACTUATOR

NON-INTERLOCKED, PNEUMATIC/ELECTRIC RELEASE WITH SERIES 776 LOW-PRESSURE ACTUATOR AND SERIES 753-E SOLENOID VALVE

SINGLE-INTERLOCKED, PNEUMATIC RELEASE WITH SERIES 776 LOW-PRESSURE ACTUATOR

SINGLE-INTERLOCKED, ELECTRIC RELEASE WITH SERIES 753-E SOLENOID VALVE

DOUBLE-INTERLOCKED, ELECTRIC (ELECTRIC-PNEUMATIC/ELECTRIC) RELEASE WITH SERIES 753-E SOLENOID VALVE



WCAS-7EFFBU

For complete contact information, visit www.victaulic.com

I-769P 4259 REV D UPDATED 05/2008 Z000769P00

VICTAULIC IS A REGISTERED TRADEMARK OF VICTAULIC COMPANY. © 2007 VICTAULIC COMPANY. ALL RIGHTS RESERVED. PRINTED IN THE USA.

I-769P



PREACTION-PAC
with NOTIFIER RP-2001 RELEASING CONTROL PANEL
INSTALLATION, OPERATION, AND MAINTENANCE MANUAL
P/N 10-500001-00C
VERSION 1.1 – JULY 2011

SECTION

3

General Air Products
Manual OILLESSINST

Compressor

OIL-LESS COMPRESSOR INSTRUCTION SHEETS

NOTE

This compressor is intended for installation indoors for use on dry sprinkler systems in accordance with the Standard for Installation of Sprinkler Systems, NFPA 13 and the National Electrical Code, NFPA 70. The compressor should be sized to restore and maintain the air pressure in the sprinkler system in accordance with the requirements in NFPA 13.

DANGER

This compressor is not equipped and should NOT be used "as is" to supply breathing quality air.

WARNING

Motors, electrical equipment and controls can cause electrical arcs that will ignite a flammable gas or vapor. Never operate or repair in or near a flammable gas or vapor. Never store flammable liquids or gases near the compressor.

WARNING

These compressors are suitable for pumping only atmospheric air. As defined in Compressed Gas Association Pamphlet G-7, page 3, atmospheric air is a mixture of elements and compounds where nitrogen and oxygen comprise more than 99% with all other trace gases comprising less than 1%. **DO NOT USE THIS COMPRESSOR IN CONTAMINATED ENVIRONMENTS OR FOR PUMPING MIXTURES OTHER THAN ATMOSPHERIC AIR**

WARNING

Compressed air contains liquid water and is saturated with water vapor, which can freeze. Do not connect compressor outlet to freezer rooms or systems exposed to temperatures below freezing. If system connects to a freezer room or area exposed to freezing temperatures, a Dry Air Pac™ should be used.

Receiving

Your compressor is inspected at the factory and packaged to protect against shipping damage. When the compressor is unpacked, inspect for damage or missing parts. All claims should be settled directly with the freight company.

WARNING: Do not operate this compressor if damaged during shipment, handling, or use. Damage may result in bursting and cause injury or property damage.

Location

NOTE: Do not connect compressor intake to freezer room. – CALL 1-800-345-8207.

Locate the compressor in a clean, well-ventilated area where the air is relatively cool, clean, and dry. A 110°F (35 C) maximum and 40°F (4.5 C) minimum temperature for surrounding and inlet air are recommended. Provide at least 12 to 18 inches from any wall or other obstruction that will interfere with airflow through the motor's fan built into the motor. Blocking airflow through the fan may cause the compressor to over heat. Do not place the compressor in an area of excessive heat, such as near a boiler.

Mounting

Riser mounted compressors may be mounted to a firm level floor, wall or system riser. A mounting bracket

and straps are provided. Tank mounted compressors should be bolted to the floor using the bolt holes provided in the tank legs. Always shim the unit level before bolting it to the floor. Vibration isolators (P/N KVP4X4) are recommended. When using isolator pads, do not draw bolts tight. Allow the pad to absorb vibrations. When isolators are used, a flexible hose (P/N P1202MP) should be installed between the compressor and service piping.

Lubrication

NOTE: This compressor is designed for non-lubricated service. Bearings are permanently lubricated. Do not lubricate any part of the compressor or motor.

Piping (reference "Installation Instructions" drawings)

WARNING

Compressed air contains liquid water and is saturated with water vapor, which can freeze. Do not connect compressor outlet to freezer rooms or systems exposed to temperatures below freezing. If system connects to a freezer room or area exposed to freezing temperatures, a Dry Air Pac™ should be used.

Piping between the compressor, accessory items and the sprinkler system should be at least ½" internal

For Assistance Please Call 1-800 345-8207

Please keep these instructions for future reference.

✿GENERAL AIR PRODUCTS, INC.

diameter to minimize pressure drop from the compressor to system. Larger pipe size may be required by code and may be substituted with no adverse effects. Smaller line size must not be used and will restrict the compressor flow, lowering capacity and causing the compressor/motor to work harder, which shortens compressor/motor life. All piping connected to the compressor must be fully supported and not transfer any loads to the compressor.

If an AMD-1 is used, allow sufficient distance between the compressor and AMD-1 to ensure that the maximum temperature at the AMD-1 is 200°F or less.

When an AMD is used with riser mounted units, a riser mounted tank kit (p/n OLR-TK) should be installed to prevent short cycling the compressor.

All oil-less compressors include a relief valve. For riser mounted models, the relief valve is installed on the compressor outlet. For tank mounted models, an ASME Code relief valve is mounted on the compressor's tank. This valve will open at a preset value above the pressure switch setting to prevent excess tank pressure in the event of switch failure.

WARNING: Do not attempt to change the safety relief valve setting.

A manual drain is provided on the bottom of each tank mounted compressor. Moisture accumulated in the tank, must be drained weekly. An automatic drain , P/N DVA-2T, is recommended in areas of high humidity.

The compressor outlet piping should contain an accessible drain. As a minimum a manual drain may be used, but an automatic drain is recommended to remove excess water.

NOTE: Accumulation of condensed water in a system causes corrosion of components and reduces system capacity.

NOTICE: Warranty is void if a separate check valve is not installed to prevent water back flow.

Wiring (reference "Wiring Instructions" drawings)

WARNING

Have a qualified electrician wire the compressor to ensure that the supply line has the same characteristics (voltage, frequency and phasing) as the motor. Wiring must comply with all local and national codes.

CAUTION

Inadequate wiring size can cause insufficient voltage at the compressor during start-up. Overheating and damage to the motor and controls may result

The supply wire must be of adequate size and no other equipment should be connected to the same line. The table below lists the recommended wire size for each model, based on a 100' run. Consult factory for longer runs.

MINIMUM RECOMMENDED WIRE SIZE		
MODEL	1 PHASE	3 PHASE
OL11016**	12	N/A
OL21533**	10	N/A
OL33550**	8	12
OL42575**	8	12
OL435V75**	8	12
OL525100**	8	12
OL610V100**	8	12
OL675150**	6	12
OL900V100**	8	12
OL900V150**	8	12
OL1200V200**	10	10

The motors supplied are multiple voltage motors. A label on the pressure switch cover indicates the voltage the motor is pre-wired for. If the supply voltage, on site, is different from the voltage indicated on this label, change the internal motor voltage connections to match the supply voltage. To change internal voltage connections, remove the cover plate located on the rear or side of the motor and reconnect the wire leads as shown on the motor's wiring diagram.

On all three phase and ½ Hp and ¾ Hp single phase models, an arrow on the motor indicates the direction of rotation of the compressor. If the compressor rotates in the opposite direction, reverse the rotation of the motor. On single phase units, reverse motor rotation by interchanging the red and black motor leads. Interchanging any two incoming supply wires reverses rotation of three phase motors.

NOTICE: **Single-phase oil-less compressors can not be operated at 208V. Operating the compressor at 208V voids the warranty.**

NOTICE: Single-phase motors include internal thermal overload protection, which has an automatic reset device.

WARNING: Disconnect electrical power before servicing to disable reset devices. Thermal protection can automatically start the motor when the protector resets.

On single phase models, the motor is pre-wired to the pressure switch provided, which controls starting (cut

GENERAL AIR PRODUCTS, INC.

in pressure) and stopping (cut out pressure) of the motor. The pressure switch is factory set. Standard models switch is set at 27 psig cut in and 40 psig cut out. Low pressure models (“-LP”) switch is set at 13 psig cut in and 18 psig cut out. Consult General Air Products before adjusting the pressure switch.

On three-phase compressors, the motor is not pre-wired to the pressure switch. Refer to the three phase wiring instruction drawing for recommended wiring.

A magnetic starter is required, for all three phase models, to protect the motor from overload conditions. A magnetic starter is recommended, for all single phase models. Consult the National Electric Code and local codes for motor starter requirements. Refer to

the proper wiring instruction drawing for recommended wiring to a starter.

NOTE: Do not run two phases of a three phase supply through the pressure switch. Serious damage can result.

NOTE: Failure to use the pressure switch may result in overpressure of the compressor or other components in the system. Overpressure of the compressor may result in blown head gaskets or other damage.

Maintenance Instructions

WARNING
DISCONNECT, TAG AND LOCK OUT POWER SOURCE THEN RELEASE ALL PRESSURE FROM THE SYSTEM BEFORE ATTEMPTING TO INSTALL, SERVICE, RELOCATE OR PERFORM ANY SERVICE.

The following instructions are based on NORMAL operation. If the compressor is in an excessively dusty area, increase frequency of maintenance checks.

WEEKLY

- Drain condensate from receiver and traps.
- Check for unusual noise or vibration.
- Clean air filters. – **NOTE: Do not clean filters with petroleum based products.**
- Clean all external parts of the compressor and motor.

MONTHLY

- Manually test safety relief valve.
- Inspect air system for leaks and tighten nuts and cap screws as required.

QUARTERLY

- Change filters.

Limited Warranty

General Air Products, Inc. warrants its products to be free of defects in material and workmanship under normal use and service for 12 months from date of purchase. Our warranty applies only when such defective parts are returned to us, or our Authorized Service Depot, transportation prepaid, and subject to our inspection and approval. Liability is limited to repair or replacement of material found defective, free of charge, FOB our plant. Unauthorized repairs or replacements will not be subject to factory warranty. This warranty is in lieu of all other warranties, expressed or implied.

General Notes

- 1) Warranty can be voided if modifications or adjustments are made without consultation and approval; from factory personnel.
- 2) If there are any questions regarding installation or operation of this compressor, please call the 800 number listed below.

 **GENERAL AIR PRODUCTS, INC.**

For Assistance Please Call 1-800 345-8207
Please keep these instructions for future reference.

OILLESSINST
REV 080906

 GENERAL AIR PRODUCTS, INC.

Trouble Shooting Guide

Symptom	Possible Cause(s)	Corrective Action
Motor hums and runs slowly or not at all	<ol style="list-style-type: none"> 1. Low voltage or no voltage 2. Shorted or open motor winding 3. Defective check valve 4. Defective pressure switch – contacts will not close 	<ol style="list-style-type: none"> 1. Check voltage during attempt to start. Voltage must be within +/-10% of nominal voltage to start motor. Increase wire size if necessary to lower voltage drop. 2. Replace motor 3. Replace check valve 4. Repair or replace pressure switch
Reset mechanism cuts out repeatedly or fuses blow repeatedly	<ol style="list-style-type: none"> 1. Insufficient voltage to motor 2. Pressure switch set too high 3. Wrong fuse size 4. Piping too restrictive 5. Defective motor 	<ol style="list-style-type: none"> 1. Check voltage during attempt to start. Voltage must be within +/-10% of nominal voltage to start motor. Increase wire size if necessary to lower voltage drop. 2. Consult factory, adjust or replace 3. Be sure fuses and heaters are rated properly 4. Add receiver vessel or increase pipe volume after compressor. 5. Replace motor
Unit short cycles repeatedly	<ol style="list-style-type: none"> 1. Piping too restrictive 2. Leak in line before system check valve 	<ol style="list-style-type: none"> 1. Add receiver vessel or increase pipe volume after compressor. 2. Repair leaks(s)
Compressor Overheating	<ol style="list-style-type: none"> 1. Dirty intake filter 2. Wrong motor rotation 3. Air flow to fan on flywheel blocked 	<ol style="list-style-type: none"> 1. Clean intake filter 2. Correct rotation 3. Clear air flow to fan or relocate unit
Excessive noise in operation	<ol style="list-style-type: none"> 1. Damaged bearings 2. Worn piston rings or skirts 3. Broken valves 4. Loose blower wheel 5. Damaged Blower baffle 	<ol style="list-style-type: none"> 1. Contact General Air Products, Inc. Service Department. 1-(800)345-8207
System pressure builds slowly	<ol style="list-style-type: none"> 1. Compressor sized incorrectly 2. Leaks or restrictions in piping 3. Dirty intake filter 4. Blown head gasket 	<ol style="list-style-type: none"> 1. Check system size and compressor sizing 2. Correct leaks and remove restrictions 3. Clean intake filter 4. Replace head gasket

For Assistance Please Call 1-800 345-8207
Please keep these instructions for future reference.

RISER MOUNT OIL-LESS COMPRESSORS WITH RISER TANK KIT INSTALLATION INSTRUCTIONS



ALL PIPING AND WIRING TO BE IN ACCORDANCE WITH APPLICABLE STATE, LOCAL AND NATIONAL CODES & SHOULD BE APPROVED BY AHJ

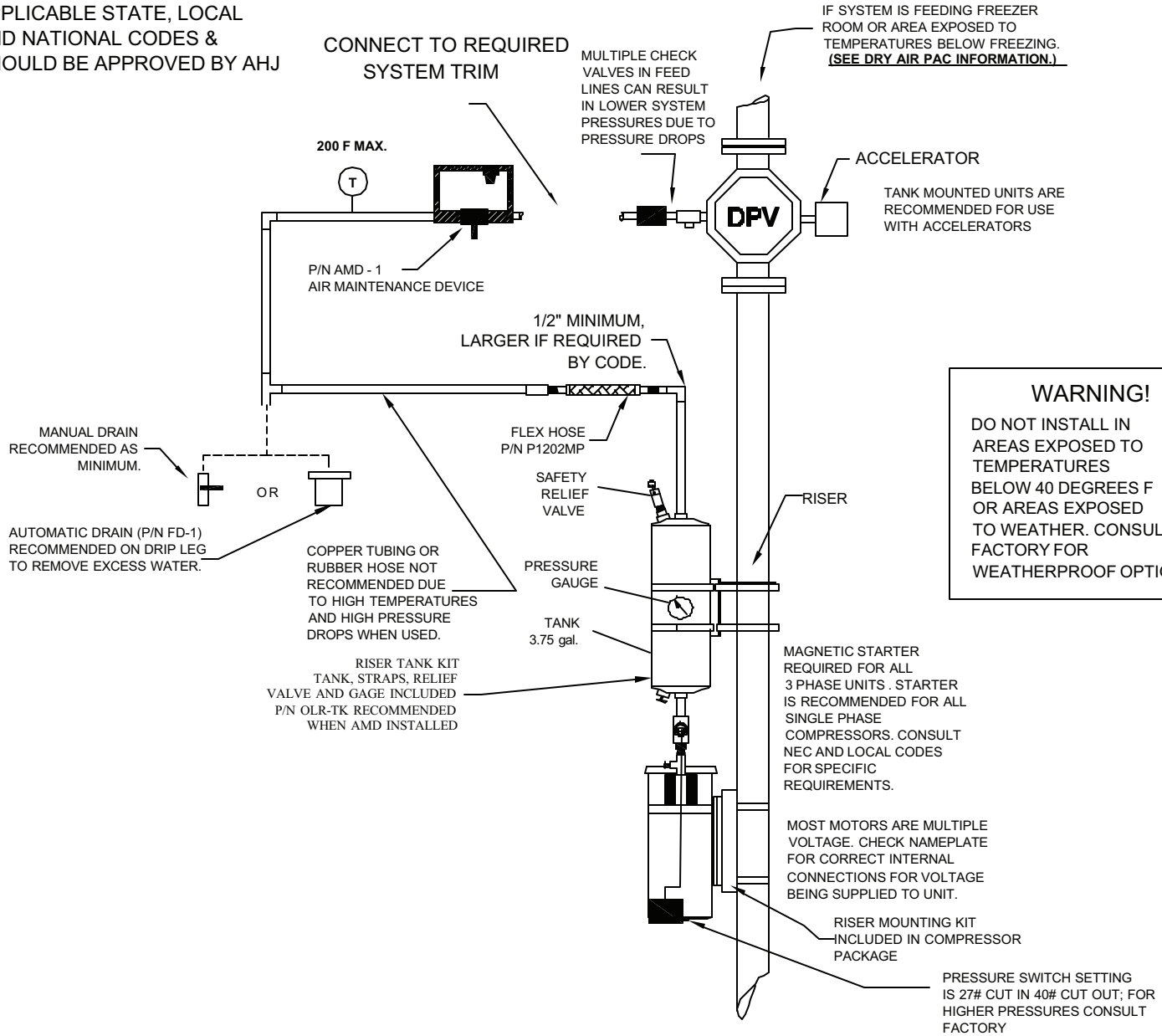

PART NUMBERS LISTED ARE FOR ACCESSORY ITEMS RECOMMENDED FOR COMPLETE INSTALLATION - CONSULT YOUR LOCAL DISTRIBUTOR FOR AVAILABILITY

TANK MOUNTED OIL-LESS COMPRESSORS INSTALLATION INSTRUCTIONS



ALL PIPING AND WIRING TO BE IN ACCORDANCE WITH APPLICABLE STATE, LOCAL AND NATIONAL CODES & SHOULD BE APPROVED BY AHJ

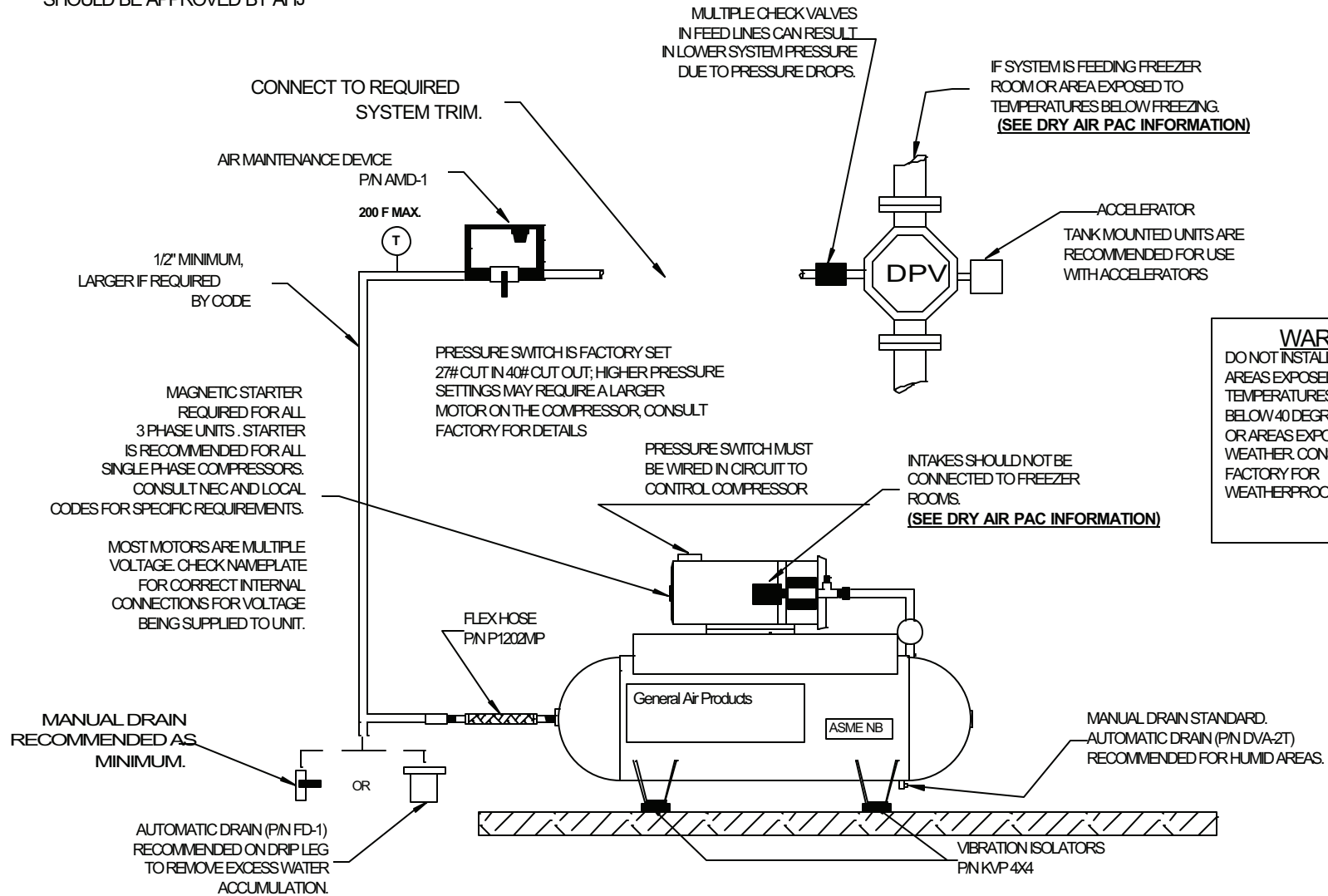

WARNING!
DO NOT INSTALL IN AREAS EXPOSED TO TEMPERATURES BELOW 40 DEGREES F OR AREAS EXPOSED TO WEATHER. CONSULT FACTORY FOR WEATHERPROOF OPTIONS.

PART NUMBERS LISTED ARE FOR ACCESSORY ITEMS RECOMMENDED FOR COMPLETE INSTALLATION - CONSULT YOUR LOCAL DISTRIBUTOR FOR AVAILABILITY

OIL-LESS COMPRESSOR SINGLE PHASE WIRING INSTRUCTIONS

NOTE: MOST MOTORS ARE MULTIPLE VOLTAGE. CHECK NAMEPLATE AND VERIFY CORRECT INTERNAL CONNECTIONS FOR VOLTAGE BEING SUPPLIED TO UNIT.

FEEDER WIRE SIZE MUST BE CAPABLE OF CARRYING CURRENT LOAD OF COMPRESSOR AT MAXIMUM PRESSURE.

FIG 1

SINGLE PHASE BUILT IN OVERLOAD PROTECTION. (NOT TO EXCEED 3/4 HP).

FOR 115V ELIMINATE FUSE IN GROUND LEG.

PRESSURE SWITCH HP RATING MUST NOT BE EXCEEDED.

OTHER WIRING VARIATIONS POSSIBLE DEPENDING ON LOCAL CODES.

PRESSURE SWITCH

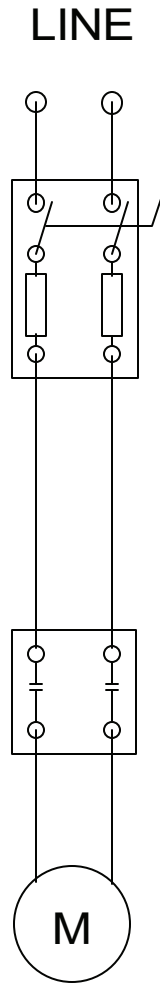

FIG 1

FIG 2

SINGLE PHASE WITH OR WITHOUT OVERLOAD PROTECTION.

FOR 115V ELIMINATE FUSE IN GROUND LEG.

PRESSURE SWITCH TO CONTROL PILOT CIRCUIT.

OTHER WIRING VARIATIONS POSSIBLE DEPENDING ON LOCAL CODES.

CONSULT MANUFACTURER'S INSTRUCTIONS ON STARTER FOR VARIATIONS ON DIAGRAM SHOWN.

PRESSURE SWITCH

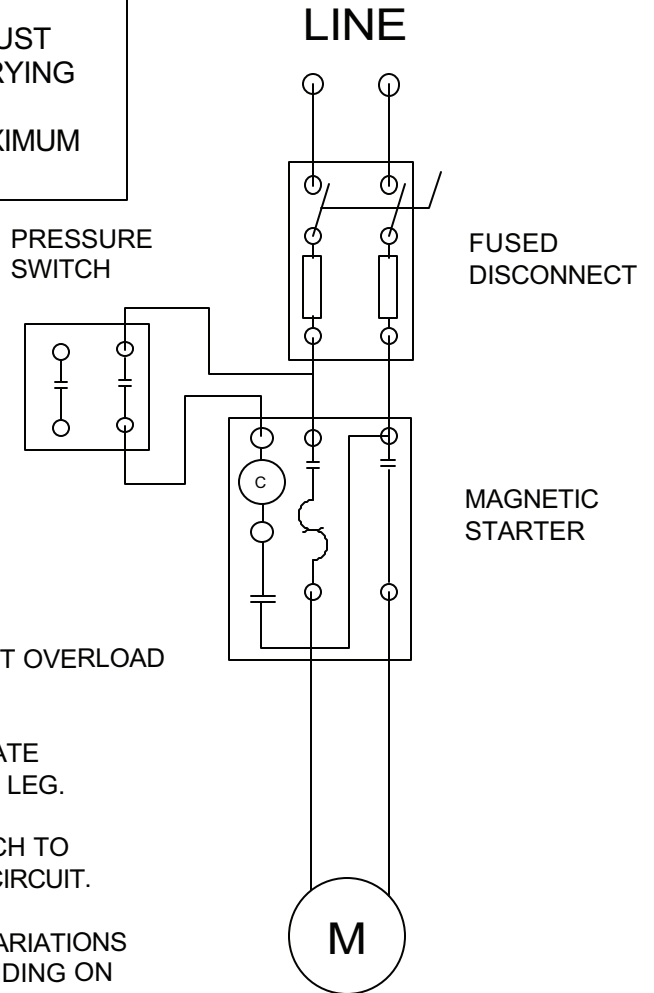

FIG 2

OIL-LESS COMPRESSOR THREE PHASE WIRING INSTRUCTIONS



NOTE: MOST MOTORS ARE MULTIPLE VOLTAGE. CHECK NAMEPLATE AND VERIFY CORRECT INTERNAL CONNECTIONS FOR VOLTAGE BEING SUPPLIED TO UNIT.

FEEDER WIRE SIZE MUST BE CAPABLE OF CARRYING CURRENT LOAD OF COMPRESSOR AT MAXIMUM PRESSURE.

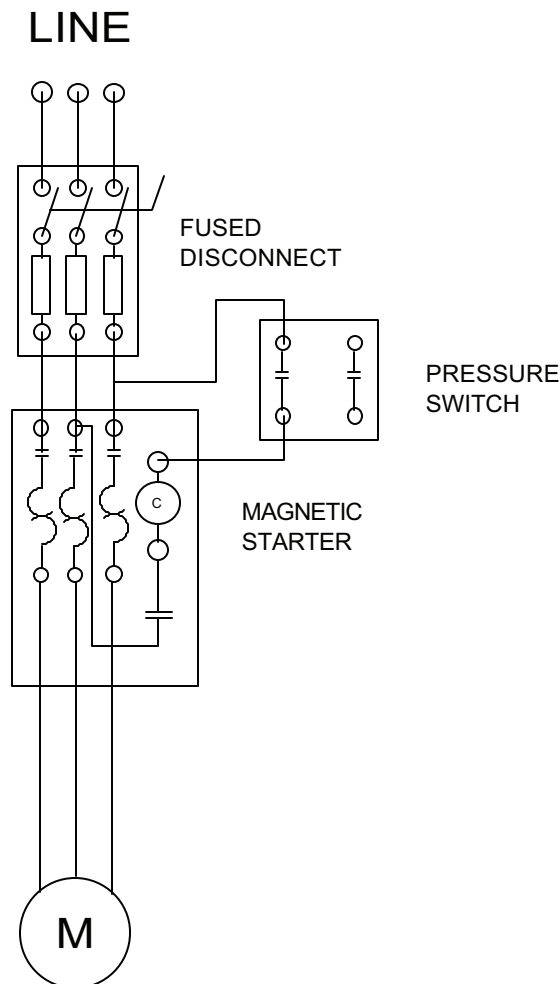

THREE PHASE

OTHER WIRING VARIATIONS POSSIBLE DEPENDING ON LOCAL CODES

PRESSURE SWITCH TO CONTROL PILOT CIRCUIT

CONSULT MANUFACTURERS INSTRUCTIONS ON STARTER FOR VARIATIONS ON DIAGRAM SHOWN

SECTION

4

Notifier Manual 52985

RP-2001 Control Panel
Installation, Operation,
Programming

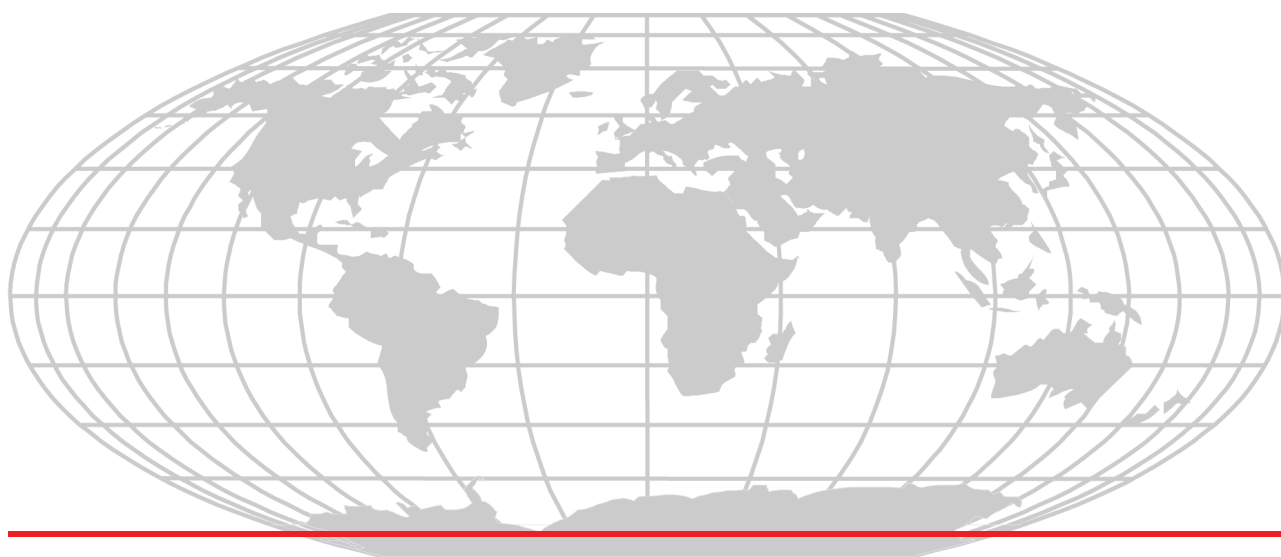

PRE-ACTION/DELUGE CONTROL PANEL
RP-2001
RP-2001E
RP-2001C
Instruction Manual

Document 52985
6/4/2010

Rev:

C

P/N 52985:C

ECN 10-281

Fire Alarm System Limitations

While a fire alarm system may lower insurance rates, it is not a substitute for fire insurance!

An automatic fire alarm system—typically made up of smoke detectors, heat detectors, manual pull stations, audible warning devices, and a fire alarm control panel with remote notification capability—can provide early warning of a developing fire. Such a system, however, does not assure protection against property damage or loss of life resulting from a fire.

The Manufacturer recommends that smoke and/or heat detectors be located throughout a protected premise following the recommendations of the current edition of the National Fire Protection Association Standard 72 (NFPA 72), manufacturer's recommendations, State and local codes, and the recommendations contained in the Guides for Proper Use of System Smoke Detectors, which are made available at no charge to all installing dealers. These documents can be found at <http://www.systemsensor.com/html/applicat.html>. A study by the Federal Emergency Management Agency (an agency of the United States government) indicated that smoke detectors may not go off in as many as 35% of all fires. While fire alarm systems are designed to provide early warning against fire, they do not guarantee warning or protection against fire. A fire alarm system may not provide timely or adequate warning, or simply may not function, for a variety of reasons:

Smoke detectors may not sense fire where smoke cannot reach the detectors such as in chimneys, in or behind walls, on roofs, or on the other side of closed doors. Smoke detectors also may not sense a fire on another level or floor of a building. A second-floor detector, for example, may not sense a first-floor or basement fire.

Particles of combustion or "smoke" from a developing fire may not reach the sensing chambers of smoke detectors because:

- Barriers such as closed or partially closed doors, walls, or chimneys may inhibit particle or smoke flow.
- Smoke particles may become "cold," stratify, and not reach the ceiling or upper walls where detectors are located.
- Smoke particles may be blown away from detectors by air outlets.
- Smoke particles may be drawn into air returns before reaching the detector.

The amount of "smoke" present may be insufficient to alarm smoke detectors. Smoke detectors are designed to alarm at various levels of smoke density. If such density levels are not created by a developing fire at the location of detectors, the detectors will not go into alarm.

Smoke detectors, even when working properly, have sensing limitations. Detectors that have photoelectronic sensing chambers tend to detect smoldering fires better than flaming fires, which have little visible smoke. Detectors that have ionizing-type sensing chambers tend to detect fast-flaming fires better than smoldering fires. Because fires develop in different ways and are often unpredictable in their growth, neither type of detector is necessarily best and a given type of detector may not provide adequate warning of a fire.

Smoke detectors cannot be expected to provide adequate warning of fires caused by arson, children playing with matches (especially in bedrooms), smoking in bed, and violent explosions (caused by escaping gas, improper storage of flammable materials, etc.).

Heat detectors do not sense particles of combustion and alarm only when heat on their sensors increases at a predetermined rate or reaches a predetermined level. Rate-of-rise heat detectors may be subject to reduced sensitivity over time. For this reason, the rate-of-rise feature of each detector should be tested at least once per year by a qualified fire protection specialist. Heat detectors are designed to protect property, not life.

IMPORTANT! Smoke detectors must be installed in the same room as the control panel and in rooms used by the system for the connection of alarm transmission wiring, communications, signaling, and/or power. If detectors are not so located, a developing fire may damage the alarm system, crippling its ability to report a fire.

Audible warning devices such as bells may not alert people if these devices are located on the other side of closed or partly open doors or are located on another floor of a building. Any warning device may fail to alert people with a disability or those who have recently consumed drugs, alcohol or medication. Please note that:

- Strobes can, under certain circumstances, cause seizures in people with conditions such as epilepsy.
- Studies have shown that certain people, even when they hear a fire alarm signal, do not respond or comprehend the meaning of the signal. It is the property owner's responsibility to conduct fire drills and other training exercise to make people aware of fire alarm signals and instruct them on the proper reaction to alarm signals.
- In rare instances, the sounding of a warning device can cause temporary or permanent hearing loss.

A fire alarm system will not operate without any electrical power. If AC power fails, the system will operate from standby batteries only for a specified time and only if the batteries have been properly maintained and replaced regularly.

Equipment used in the system may not be technically compatible with the control panel. It is essential to use only equipment listed for service with your control panel.

Telephone lines needed to transmit alarm signals from a premise to a central monitoring station may be out of service or temporarily disabled. For added protection against telephone line failure, backup radio transmission systems are recommended.

The most common cause of fire alarm malfunction is inadequate maintenance. To keep the entire fire alarm system in excellent working order, ongoing maintenance is required per the manufacturer's recommendations, and UL and NFPA standards. At a minimum, the requirements of NFPA 72 shall be followed. Environments with large amounts of dust, dirt or high air velocity require more frequent maintenance. A maintenance agreement should be arranged through the local manufacturer's representative. Maintenance should be scheduled monthly or as required by National and/or local fire codes and should be performed by authorized professional fire alarm installers only. Adequate written records of all inspections should be kept.

Limit-C1-2-2007

Installation Precautions

Adherence to the following will aid in problem-free installation with long-term reliability:

WARNING - Several different sources of power can be connected to the fire alarm control panel. Disconnect all sources of power before servicing. Control unit and associated equipment may be damaged by removing and/or inserting cards, modules, or interconnecting cables while the unit is energized. Do not attempt to install, service, or operate this unit until manuals are read and understood.

CAUTION - System Re-acceptance Test after Software Changes: To ensure proper system operation, this product must be tested in accordance with NFPA 72 after any programming operation or change in site-specific software. Re-acceptance testing is required after any change, addition or deletion of system components, or after any modification, repair or adjustment to system hardware or wiring. All components, circuits, system operations, or software functions known to be affected by a change must be 100% tested. In addition, to ensure that other operations are not inadvertently affected, at least 10% of initiating devices that are not directly affected by the change, up to a maximum of 50 devices, must also be tested and proper system operation verified.

This system meets NFPA requirements for operation at 0-49° C/32-120° F and at a relative humidity 93% ± 2% RH (non-condensing) at 32°C ± 2°C (90°F ± 3°F). However, the useful life of the system's standby batteries and the electronic components may be adversely affected by extreme temperature ranges and humidity. Therefore, it is recommended that this system and its peripherals be installed in an environment with a normal room temperature of 15-27° C/60-80° F.

Verify that wire sizes are adequate for all initiating and indicating device loops. Most devices cannot tolerate more than a 10% I.R. drop from the specified device voltage.

Like all solid state electronic devices, this system may operate erratically or can be damaged when subjected to lightning induced transients. Although no system is completely immune from lightning transients and interference, proper grounding will reduce susceptibility. Overhead or outside aerial wiring is not recommended, due to an increased susceptibility to nearby lightning strikes. Consult with the Technical Services Department if any problems are anticipated or encountered.

Disconnect AC power and batteries prior to removing or inserting circuit boards. Failure to do so can damage circuits.

Remove all electronic assemblies prior to any drilling, filing, reaming, or punching of the enclosure. When possible, make all cable entries from the sides or rear. Before making modifications, verify that they will not interfere with battery, transformer, or printed circuit board location.

Do not tighten screw terminals more than 9 in-lbs. Overtightening may damage threads, resulting in reduced terminal contact pressure and difficulty with screw terminal removal.

This system contains static-sensitive components.

Always ground yourself with a proper wrist strap before handling any circuits so that static charges are removed from the body. Use static suppressive packaging to protect electronic assemblies removed from the unit.

Follow the instructions in the installation, operating, and programming manuals. These instructions must be followed to avoid damage to the control panel and associated equipment. FACP operation and reliability depend upon proper installation.

Precau-D1-9-2005

FCC Warning

WARNING: This equipment generates, uses, and can radiate radio frequency energy and if not installed and used in accordance with the instruction manual may cause interference to radio communications. It has been tested and found to comply with the limits for class A computing devices pursuant to Subpart B of Part 15 of FCC Rules, which is designed to provide reasonable protection against such interference when devices are operated in a commercial environment. Operation of this equipment in a residential area is likely to cause interference, in which case the user will be required to correct the interference at his or her own expense.

Canadian Requirements

This digital apparatus does not exceed the Class A limits for radiation noise emissions from digital apparatus set out in the Radio Interference Regulations of the Canadian Department of Communications.

Le present appareil numerique n'emet pas de bruits radioelectriques dépassant les limites applicables aux appareils numeriques de la classe A prescrites dans le Reglement sur le brouillage radioelectrique edicte par le ministere des Communications du Canada.

LiteSpeed™ is a trademark; and Notifier® and FireWarden® are registered trademarks of Honeywell International Inc. Echelon® is a registered trademark and LonWorks™ is a trademark of Echelon Corporation. ARCNET® is a registered trademark of Datapoint Corporation. Microsoft® and Windows® are registered trademarks of the Microsoft Corporation.

©2010 by Honeywell International Inc. All rights reserved. Unauthorized use of this document is strictly prohibited.

Software Downloads

In order to supply the latest features and functionality in fire alarm and life safety technology to our customers, we make frequent upgrades to the embedded software in our products. To ensure that you are installing and programming the latest features, we strongly recommend that you download the most current version of software for each product prior to commissioning any system. Contact Technical Support with any questions about software and the appropriate version for a specific application.

Documentation Feedback

Your feedback helps us keep our documentation up-to-date and accurate. If you have any comments or suggestions about our online Help or printed manuals, you can email us.

Please include the following information:

- Product name and version number (if applicable)
- Printed manual or online Help
- Topic Title (for online Help)
- Page number (for printed manual)
- Brief description of content you think should be improved or corrected
- Your suggestion for how to correct/improve documentation

Send email messages to:

FireSystems.TechPubs@honeywell.com

Please note this email address is for documentation feedback only. If you have any technical issues, please contact Technical Services.

Table of Contents

Section 1: Product Description	11
1.1: Product Features	11
1.2: Specifications.....	13
1.3: Controls and Indicators.....	14
1.4: Components	15
1.5: Optional Modules and Accessories	15
Section 2: Installation.....	17
2.1: Backbox Mounting	17
2.2: Operating Power	20
2.3: Input Circuits	22
2.4: Output Circuits.....	24
2.4.1: Outputs/Notification Appliance/Releasing Circuits	24
2.4.2: Special Application DC Power Output Connections.....	25
2.4.3: Relays - Programmable	25
2.5: Power-limited Wiring Requirements	26
2.6: Installation of Optional Modules	27
2.6.1: N-CAC-5X Class A Converter Module.....	27
Installation	27
Wiring NACs and IDCs for Class A	28
2.6.2: 4XTM Municipal Box Transmitter Option Module	29
4XTM Transmitter Module Installation	29
2.7: ANN-BUS Devices.....	31
2.7.1: ANN-BUS Wiring	31
Calculating Wiring Distance for ANN-BUS Modules.....	31
Wiring Configuration	33
Powering ANN-BUS Devices from Auxiliary Power Supply	34
2.7.2: ANN-BUS Device Addressing.....	34
2.7.3: N-ANN-80 Remote LCD Annunciator.....	35
2.7.4: Specifications.....	35
2.7.5: Installation	35
Mounting	35
Opening/Closing Annunciator.....	35
Wiring N-ANN-80 to FACP	36
2.7.6: N-ANN-S/PG Serial/Parallel Printer Interface Installation.....	37
Specifications	38
PRN-6 Printer Installation	38
2.7.7: N-ANN-I/O LED Driver Module.....	39
N-ANN-I/O Board Layout	40
2.7.8: Specifications.....	40
N-ANN-I/O Connection to FACP.....	41
N-ANN-I/O Module LED Wiring.....	41
2.7.9: N-ANN-LED Annunciator Module.....	42
Specifications	42
Mounting/Installation	42
N-ANN-LED Board Layout and Connection to FACP.....	43
2.7.10: N-ANN-RLY Relay Module	43
Specifications	43
Mounting/Installation	44
N-ANN-RLY Board Layout and Connection to FACP	44
Section 3: Programming	45
3.1: User Programming.....	45
3.2: Initial Power-up	46
3.3: Programming Screens Description	46

3.4: Programming and Passwords	47
3.5: Master Programming Level	48
3.5.1: FACP CONFIG (Application Templates)	49
3.5.2: Input Zones	49
3.5.3: Output Circuits.....	55
Enabled	56
Type	56
Silence.....	58
Auto Silence.....	59
Silence Inhibited	59
Coding	60
3.5.4: Cross Input Zones	62
3.5.5: On-Board Relays	63
3.5.6: System Setup	64
Timers	65
Banner	67
Time-Date	68
Trouble Reminder.....	70
Charger Disable	70
Canadian Option	70
3.5.7: ANN-BUS.....	71
ANN-BUS Enabled	71
ANN-BUS Modules.....	71
Auto-Configure.....	72
ANN-S/PG Options	73
N-ANN-I/O LED Zone Assignments	74
ANN-80 Options.....	75
ANN-RLY Options.....	76
3.5.8: History	77
View Events.....	77
Erase History	77
3.5.9: Walktest	78
3.5.10: Clear Program	79
3.5.11: Password Change.....	79
3.6: Maintenance Programming Level.....	80
3.6.1: Input Zones - Enable/Disable	81
3.6.2: History	81
3.6.3: Walktest	82
3.6.4: Time-Date	83
Section 4: Operating Instructions	84
4.1: Panel Control Buttons	84
4.1.1: Acknowledge/Step	84
4.1.2: Alarm Silenced	84
4.1.3: Drill/Hold 2 Sec	84
4.1.4: Reset	84
4.2: Indicators.....	85
4.3: Normal Operation	85
4.4: Trouble Operation	86
4.5: Alarm Operation	87
4.6: Supervisory Operation	88
4.7: Disable/Enable Operation	88
4.8: Waterflow Circuits Operation	89
4.9: 2nd-Shot Water Switch	89
4.10: Detector Functions.....	89
4.11: Coded NAC Operation.....	89
4.12: Release Stages.....	90

4.13: Special System Timers.....	90
4.13.1: Silence Inhibit Timer.....	90
4.13.2: Autosilence Timer.....	90
4.13.3: Trouble Reminder.....	90
4.13.4: Soak Timers.....	90
4.13.5: Waterflow Delay Timer.....	90
4.14: Walktest	90
4.15: Read Status	91
4.15.1: FACP Configuration.....	92
4.15.2: Input Zones	92
4.15.3: Output Circuits	93
4.15.4: Cross Input Zones.....	94
4.15.5: On-Board Relays	94
4.15.6: System Settings	95
4.15.7: Timers.....	95
4.15.8: Daylight Savings	96
4.15.9: History	96
4.15.10: Print	96
4.15.11: ANN-BUS	97
Section 5: Power Supply Calculations.....	98
5.1: Overview.....	98
5.2: Calculating the AC Branch Circuit.....	98
5.3: Calculating the System Current Draw	99
5.3.1: Overview	99
5.3.2: How to Use Table 5.3 on page 100 to Calculate System Current Draw	99
5.4: Calculating the Battery Size	101
5.4.1: NFPA Battery Requirements.....	101
5.4.2: Selecting and Locating Batteries	101
Appendix A: Circuit Mapping and Cross-Zoning.....	102
A.1: Input-to-Output Circuit Mapping and Cross-Zone Operation	102
A.1.1: Mapping Input Zones to Output Circuits for Direct Activation.....	103
A.1.2: Mapping Input Zones to Release Circuits for Cross Zone Activation.....	104
A.1.3: Complex Examples of Cross Zoning and I/O Mapping for Release Circuits.....	106
Appendix B: FACP Configuration Templates.....	107
B.1: Template 1: Single Hazard - 3 Zone	108
B.2: Template 2: Single Hazard - Cross-Zone With Manual Release	110
B.3: Template 3: Dual Hazard - Combined Release	112
B.4: Template 4: Dual Hazard - Split Release	114
B.5: Template 5: Single Hazard - 3 Zones and Low Pressure	116
B.6: Template 6: Single Hazard - 2 Zones Cross-Zoned With All Active.....	118
B.7: Template 7: Single Hazard - Dual Zone.....	120
Appendix C: NFPA Standard-Specific Requirements	122
C.1: NFPA 72 Auxiliary Fire Alarm System	125
C.2: Central Station/Remote Station Transmitter: Connection to FACP Dry Contacts.....	128
Appendix D: FACP with Keltron	129
Appendix E: Testing & Maintenance.....	130
E.1: Testing	130
E.1.1: Inspection	130
E.1.2: Alarm Test.....	130
E.1.3: Detector Testing	130
E.2: Maintenance	131

Appendix F: Wire Requirements	132
F.1: NAC Wiring	133
Index	134

It is imperative that the installer understand the requirements of the Authority Having Jurisdiction (AHJ) and be familiar with the standards set forth by the following regulatory agencies:

- Underwriters Laboratories Standards
- NFPA 72 National Fire Alarm Code
- CAN/ULC - S527-99 Standard for Control Units for Fire Alarm Systems

Before proceeding, the installer should be familiar with the following documents.



NFPA Standards

This Fire Alarm Control Panel complies with the following NFPA Standards:

- NFPA 13 Installation of Sprinkler Systems
- NFPA 15 Water Spray Fixed Systems
- NFPA 16 Deluge Foam-Water Sprinkler and Foam-Water Spray Systems
- NFPA 72 National Fire Alarm Code for Local Fire Alarm Systems and Remote Station Fire Alarm Systems (requires an optional Remote Station Output Module)



Underwriters Laboratories Documents for Reference:

- UL 38 Manually Actuated Signaling Boxes
- UL 217 Smoke Detectors, Single and Multiple Station
- UL 228 Door Closers—Holders for Fire Protective Signaling Systems
- UL 268 Smoke Detectors for Fire Protective Signaling Systems
- UL 268A Smoke Detectors for Duct Applications
- UL 346 Waterflow Indicators for Fire Protective Signaling Systems
- UL 464 Audible Signaling Appliances
- UL 521 Heat Detectors for Fire Protective Signaling Systems
- UL 864 Standard for Control Units for Fire Protective Signaling Systems
- UL 1481 Power Supplies for Fire Protective Signaling Systems
- UL 1638 Visual Signaling Appliances
- UL 1971 Signaling Devices for Hearing Impaired



CAN/ULC - S524-01 Standard for Installation of Fire Alarm Systems

This Class (A) digital apparatus complies with Canadian ICES-003.
Cet appareil numérique de la classe (A) est conforme à la norme NMB-003 du Canada.

Other:

- NEC Article 250 Grounding
- NEC Article 300 Wiring Methods
- NEC Article 760 Fire Protective Signaling Systems
- Applicable Local and State Building Codes
- Requirements of the Local Authority Having Jurisdiction (LAHJ)

Notifier Documents

Notifier Device Compatibility Document	Document #15378
411UD Manual	Document #50759
411UDAC Manual	Document #51073
N-ANN-80 Product Installation Doc.	Document #52986
N-ANN-(R)LED Product Installation Doc.	Document #53317
N-ANN-I/O Product Installation Doc.	Document #151243
N-ANN-RLY Product Installation Doc.	Document #53318
N-ANN-S/PG Product Installation Doc.	Document #151424

This product has been certified to comply with the requirements in the Standard for Control Units and Accessories for Fire Alarm Systems, UL 864, 9th Edition. Operation of this product with products not tested for UL 864, 9th Edition has not been evaluated. Such operation requires the approval of the local Authority Having Jurisdiction (AHJ).

FACP Main Circuit Board

Basic System Connections

Output Circuits - TB5 & TB7

In this example NAC Output Circuits #1, #3 & #4 (Class B) (Supervised, Power Limited - Class 2) NAC Output Circuit #2 (Releasing) & Style Y (Class B) (Supervised, NonPower-Limited, Class 1) 3.0 amps max. per circuit. (See Style Z illustrated near right edge of board). 4.7KΩ, ½ watt End-of-Line Resistor PN 71252

Input Initiating Device Circuit - TB4 & TB6

IDCs 1 through 6, Style B (Class B) (Supervised, Power Limited, Class 2) (See Style D illustrated near right edge of board). 4.7KΩ, ½ watt End-of-Line Resistor PN 71252

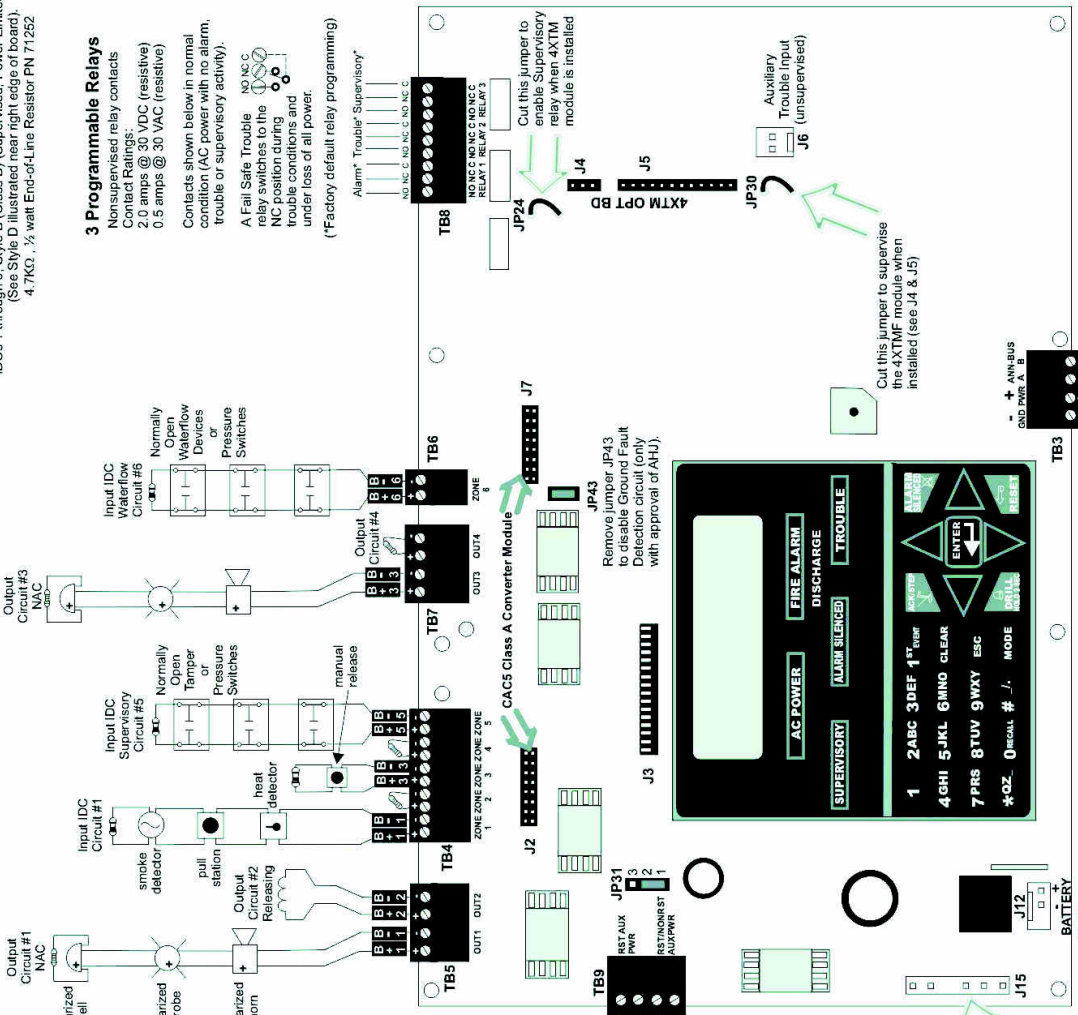

3 Programmable Relays
 Nonsupervised relay contacts
 Contact Ratings:
 2.0 amps @ 30 VDC (resistive)
 0.5 amps @ 30 VAC (resistive)
 Contacts shown below in normal condition (AC power with no alarm, trouble or supervisory activity).
 A Fail Safe Trouble relay switches to the NC position during trouble conditions and under loss of all power.
 (*Factory default relay programming)
 Alarm* Trouble* Supervisory*

Special Application DC Power Outputs (24 VDC)
 Nonsupervised, power-limited circuits (Class 2)
 Supervise with a power supervision relay EOLR-1

- Resettable Power - 24 VDC filtered, power-limited, Class 2 (0.500 amps maximum) to smoke detectors (DC). Supervise with a power supervision relay EOLR-1
- Nonresettable or Resettable Power - Inverterless, jumper JP31, 24 VDC filtered, power-limited, Class 2 (0.500 amps maximum) Supervise with a power supervision relay EOLR-1
- Nonresettable Power suitable for powering annunciators. Resettable Power suitable for powering smoke detectors. Configure TB9, Terminals 1 & 2 as Resettable or Nonresettable Power.
- Resettable Power - jumper JP31 pins 2 & 3.
- Nonresettable Power - jumper JP31 pins 1 & 2 (as shown).

For more specific UL wiring information refer to page 35.

Power Supply Connector J15

Battery
 24 VDC, supervised, nonpower-limited
 26 Amp Hour maximum

Section 1: Product Description

The RP-2001 is a six zone FACP for single and dual hazard deluge and preaction applications. The FACP provides reliable fire detection, signaling and protection for commercial, industrial and institutional buildings requiring water-based releasing. The FACP is compatible with System Sensor's i³ detectors which are conventional smoke detectors that can transmit a maintenance trouble signal to the FACP indicating the need for cleaning and a supervisory 'freeze' signal when the ambient temperature falls below the detector rating of approximately 45° F (7° C) (refer to System Sensor for i³ Installation and Maintenance Instructions). In addition, the control panel is compatible with conventional input devices such as two-wire smoke detectors, four-wire smoke detectors, pull stations, waterflow devices, tamper switches and other normally-open contact devices. Refer to Device Compatibility Document for a complete listing of compatible devices.

Four outputs are programmable as NACs (Notification Appliance Circuits) or releasing solenoids. Three programmable Form-C relays (factory programmed for Alarm, Trouble and Supervisory) and 24 VDC special application resettable and nonresettable power outputs are also included on the main circuit board. The FACP supervises all wiring, AC voltage, battery charger and battery level.

Activation of a compatible smoke detector or any normally-open fire alarm initiating device will activate audible and visual signaling devices, illuminate an indicator, display alarm information on the panel's LCD, sound the piezo sounder at the FACP, activate the FACP alarm relay and operate an optional module used to notify a remote station or initiate an auxiliary control function.

The RP-2001C (Canada) is a ULC approved Canadian version of the FACP which offers the same features as the RP-2001 but is supplied standard with a dress panel and one built-in N-ANN-LED annunciator.

The RP-2001E offers the same features as the RP-2001 but allows connection to 220/240 VAC.

Unless otherwise specified, the information in this manual applies to all versions of the panel.

1.1 Product Features

- Six programmable Style B (Class B) IDCs (Initiating Device Circuit)
- Four programmable Style Y (Class B) output circuits - (special application power)
- Three programmable Form-C relays
- 7.0 amps total 24 VDC output current
- Resettable and non-resettable output power
- Built-in Programmer
- ANN-BUS for connection to optional:
 - ✓ N-ANN-80 Remote LCD Annunciator
 - ✓ N-ANN-I/O LED Driver
 - ✓ N-ANN-S/PG Printer Module
 - ✓ N-ANN-RLY Relay Module
 - ✓ N-ANN-LED Annunciator Module
- 80-character LCD display (backlit)
- Real-time clock/calendar with daylight savings time control
- History log with 256 event storage

- Control Buttons
 - ✓ ACK (Acknowledge)
 - ✓ Alarm Silenced
 - ✓ System Reset/Lamp Test
 - ✓ Drill
 - Indicators
 - ✓ Fire Alarm
 - ✓ Supervisory
 - ✓ Trouble
 - ✓ AC Power
 - ✓ Alarm Silenced
 - ✓ Discharge
 - Piezo sounder for alarm, trouble and supervisory
 - 24 volt operation
 - Low AC voltage sense
 - Outputs Programmable for:
 - ✓ Releasing Solenoids
 - ✓ NACs programmable for:
 - Silence Inhibit
 - Auto-Silence
 - Strobe Synchronization (System Sensor, Wheelock, Gentex, Faraday, Amseco)
 - Selective Silence (horn-strobe mute)
 - Temporal or Steady Signal
 - Silenceable or Nonsilenceable
 - Release Stage Sounder
- Designed for sprinkler standards NFPA 13, 15 and 16
- Disable/Enable control per input zone and output zone
- Extensive transient protection
- Dual hazard operation
- Adjustable waterflow discharge timer and two soak timers
- Cross-zone (double-interlock) capability
- Pre-programmed and custom application templates
- Automatic battery charger with charger supervision
- Silent or audible walktest capabilities
- Optional Dress Panel DP-51050 (red)
- A modified Dress Panel is provided standard with Canadian models: includes an N-ANN-LED Annunciator module
- Optional Trim Ring TR-CE (red) for semi-flush mounting the cabinet
- Optional N-CAC-5X Class A Converter Module for Outputs and IDCs
- Optional 4XTM Municipal Box Transmitter Module
- Optional Digital Alarm Communicators (411, 411UD, 411UDAC)

1.2 Specifications

AC Power

RP-2001/C: 120 VAC, 60 Hz, 3.66 amps

RP-2001E: 240 VAC, 50 Hz, 2.085 amps

Wire size: minimum #14 AWG (2.0 mm²) with 600V insulation

Supervised, nonpower-limited

Battery (sealed lead acid only) - J12

Maximum Charging Circuit - Normal Flat Charge: 27.6 VDC @ 1.4 amp

Supervised, nonpower-limited

Maximum Charger Capacity: 26 Amp Hour battery (two 18 Amp Hour batteries can be housed in the FACP cabinet. Larger batteries require separate battery box such as the NFS-LBB)

Minimum Battery Size: 7 Amp Hour

Canadian Applications

Minimum Battery Size: 12 Amp Hour

Maximum Battery Size: 18 Amp Hour

Initiating Device Circuits - TB4 and TB6

Alarm Zones 1 - 5 on TB 4

Alarm Zone 6 on TB6

Supervised and power-limited circuitry

Operation: All zones Style B (Class B)

Normal Operating Voltage: Nominal 20 VDC

Alarm Current: 15 mA minimum

Short Circuit Current: 40 mA max.

Maximum Loop Resistance: 100 ohms (700 ohms for linear heat detection)

End-of-Line Resistor: 4.7K Ω , 1/2 watt (Part #71252)

Standby Current: 2 mA

Refer to the Device Compatibility Document for listed compatible devices

Notification Appliance and Releasing Circuit(s) - TB5 and TB7¹

Four Output Circuits

Operation: Style Y (Class B)

Special Application power

Supervised and power-limited circuitry

Normal Operating Voltage: Nominal 24 VDC

Maximum Signaling Current: 7.0 amps (3.0 amps maximum per NAC)

End-of-Line Resistor: 4.7K Ω , 1/2 watt (Part #71252)

Refer to "Wire Requirements" on page 132 for wire specifications

Refer to the Device Compatibility Document for compatible listed devices

Form-C Relays - Programmable - TB8

Relay 1 (factory default programmed as Alarm Relay)

Relay 2 (factory default programmed as fail-safe Trouble Relay)

Relay 3 (factory default programmed as Supervisory Relay)

Relay Contact Ratings: 2 amps @ 30 VDC (resistive) and 0.5 amps @ 30 VAC (resistive)

Auxiliary Trouble Input

The Auxiliary Trouble Input is an open collector, unsupervised circuit which can be used to monitor external devices for trouble conditions. It can be connected to the trouble bus of a peripheral, such as a power supply, which is compatible with open collector circuits.

All connections must be in conduit, less than 20 ft. (610 cm) in length in the same room.

1. Total current for resettable power, nonresettable power and Output Circuits must not exceed 7.0 amps.

Special Application Resettable Power - TB9

Operating Voltage: Nominal 24 VDC

Maximum Available Current: 500 mA - appropriate for powering 4-wire smoke detectors (see note 1)

Power-limited Circuitry

Refer to the *Device Compatibility Document* for compatible listed devices

Special Application Resettable or Nonresettable Power - TB9

Operating Voltage: Nominal 24 VDC

Maximum Available Current: 500 mA (see note 1)

Power-limited Circuitry

Jumper selectable by JP31 for resettable or nonresettable power:

- ✓ Jumper pins 1 & 2 on JP31 for nonresettable power
- ✓ Jumper pins 2 & 3 on JP31 for resettable power

Refer to the *Device Compatibility Document* for compatible listed devices

1.3 Controls and Indicators

LCD Display

The FACP uses an 80-character (4 lines X 20 characters) high viewing angle LCD display. The display includes a long life LED backlight that remains illuminated. If AC power is lost and the system is not in alarm, the LED backlight will turn off to conserve batteries.

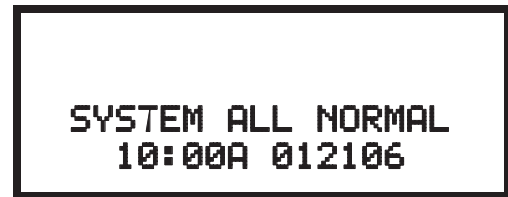

Key Panel

Mounted on the main circuit board, the key panel includes a window for the LCD display and indicators as listed above. The key panel, which is visible with the cabinet door closed, has 25 keys, including a 16 key alpha-numeric pad similar to a telephone keypad.

Function keys:

- Acknowledge/Step
- Alarm Silenced
- Drill
- System Reset (lamp test)

Service/program keys:

- Keys labeled 1 to 9
- * key
- # key
- 0 (recall) key
- 1st Event key
- Clear key
- Escape key
- Mode key
- Four cursor keys (up, down, left and right)
- Enter key

Local Piezo Sounder

A piezo sounder provides separate and distinct pulse rates for alarm, trouble and supervisory conditions.

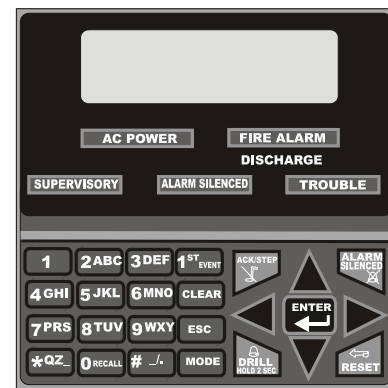

MRP2001kypd.cdr

Figure 1.1 Membrane/Display Panel

Indicators

Indicators are provided to announce the following conditions:

- Fire Alarm - red indicator
- Supervisory - yellow indicator
- AC Power - green indicator
- System Trouble - yellow indicator
- Alarm Silenced - yellow indicator
- Discharge - red indicator

Local Piezo Sounder

A piezo sounder provides separate and distinct sounds for alarm, trouble, maintenance and supervisory conditions as follows:

- Alarm - on steady
- Trouble - pulse 1 second on and 1 second off
- Maintenance - pulse ½ second on and ½ second off
- Supervisory - pulse ½ second on and ½ second off

1.4 Components

Main Circuit Board

The main circuit board contains the system's CPU and other primary components and wiring interface connectors. Optional modules plug in and are mounted to the main circuit board.

Power Supply

One FLPS-7 power supply is provided standard with each FACP, mounted to a chassis.

Cabinet

The backbox measures 16.65" (42.29 cm) x 19.0" (48.26 cm) x 5.207" (13.23 cm) and provides space for two batteries (up to 18 Amp Hours). Also available are the optional dress panel (DP-51050 [red] and trim-ring TR-CE [red]). The Canadian version is supplied standard with a modified dress panel and one N-ANN-LED annunciator module.

Batteries

The cabinet provides space for two 18 Amp Hour batteries (larger batteries require use of a UL listed battery box such as the NFS-LBB). Batteries must be ordered separately.

1.5 Optional Modules and Accessories

N-CAC-5X Class A Converter Module

The N-CAC-5X Module can be used to convert the Style B (Class B) Initiating Device Circuits to Style D (Class A) and Style Y (Class B) Output Circuits to Style Z (Class A). The modules connect to J2 and J7 on the FACP main circuit board. Note that two Class A Converter modules are required to convert all six Initiating Device Circuits and four Output Circuits.

4XTM Transmitter Module

The 4XTM provides a supervised output for local energy municipal box transmitter and alarm and trouble reverse polarity. It includes a disable switch and disable trouble LED. A module jumper option allows the reverse polarity circuit to open with a system trouble condition if no alarm condition exists. The 4XTM mounts to the main circuit board connectors J4 & J5.

N-ANN-80 LCD Annunciator

The N-ANN-80 (red) and N-ANN-80-W (white) are remote LCD annunciators that mimic the information displayed on the FACP LCD display.

N-ANN-LED Annunciator Module

The N-ANN-LED Annunciator Module provides three LEDs for each zone: Alarm, Trouble and Supervisory.

N-ANN-RLY Relay Module

The N-ANN-RLY Module, which can be mounted inside the cabinet, provides 10 Form-C relays.

N-ANN-S/PG Serial/Parallel Printer Gateway

The N-ANN-S/PG module provides a connection for a serial or parallel printer.

N-ANN-I/O LED Driver Module

The N-ANN-I/O module provides connections to a user supplied graphic annunciator.

DP-51050 Dress Panel

A dress panel DP-51050 (red) is available as an option. The dress panel restricts access to the system wiring while allowing access to the membrane switch panel. The Canadian version is supplied standard with a modified dress panel.

TR-CE Trim-ring

A trim-ring TR-CE (red) is available as an option. The trim-ring allows semi-flush mounting of the cabinet.

Battery Box

The NFS-LBB battery box may be used to house two batteries greater than 18 Amp Hour. The battery box mounts directly below the control panel cabinet, centered to the main circuit board.

Section 2: Installation

The cabinet can be surface mounted or semi-flush mounted. The door is removable during the installation period by opening and lifting it off the hinges. The cabinet mounts using two key slots at the top of the backbox and two additional securing holes located at the bottom.

Carefully unpack the system and check for shipping damage. Mount the cabinet in a clean, dry, vibration-free area where extreme temperatures or levels of humidity are not encountered. The area should be readily accessible with sufficient room to easily install and maintain the panel. Locate the top of the cabinet approximately 5 feet (1.5 m) above the floor with the hinge mounting on the left. Determine the number of conductors required for the devices to be installed. Sufficient knockouts are provided for wiring convenience. Select the appropriate knockout(s) and pull the conductors into the box. All wiring should be in accordance with the National and/or Local codes for fire alarm systems.

2.1 Backbox Mounting



CAUTION: STATIC SENSITIVE COMPONENTS

THE CIRCUIT BOARD CONTAINS STATIC-SENSITIVE COMPONENTS. ALWAYS GROUND YOURSELF WITH A PROPER WRIST STRAP BEFORE HANDLING ANY BOARDS SO THAT STATIC CHARGES ARE REMOVED FROM THE BODY. USE STATIC SUPPRESSIVE PACKAGING TO PROTECT ELECTRONIC ASSEMBLIES.

To prevent damage to the circuit board and to facilitate backbox mounting, the chassis with main circuit board and power supply can be easily removed. Loosen the two 3/8" nuts securing the top flanges of the chassis, then slide the chassis up to free it from the lower tabs. Place the chassis assembly in a protective antistatic bag in a safe location until it can be reinstalled in the backbox.

- ✓ Mark and predrill hole in the wall for the center top keyhole mounting bolt using the dimensions illustrated in Figure 2.2 on page 19
- ✓ Install center top fastener in the wall with the screw head protruding
- ✓ Place backbox over the top screw, level and secure
- ✓ Mark and drill the left and right upper and lower mounting holes
Note: outer holes (closest to sidewall) are used for 16" on-center stud mounting
- ✓ Install remaining fasteners and tighten

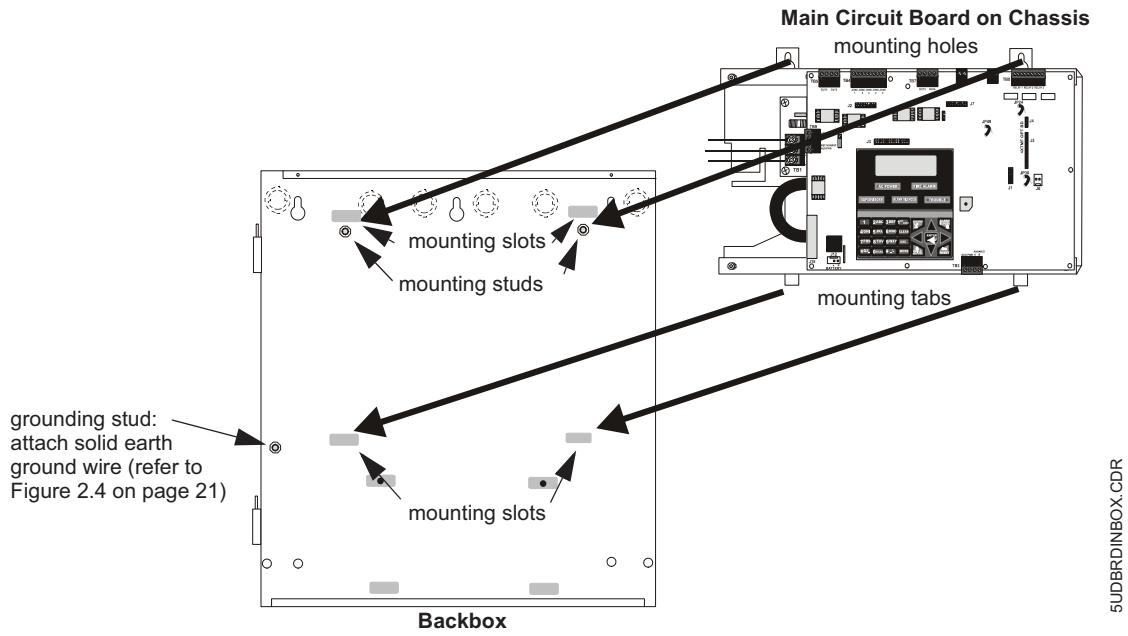

5UJBRDINBOX.CDR

Figure 2.1 Chassis Mounting in Backbox

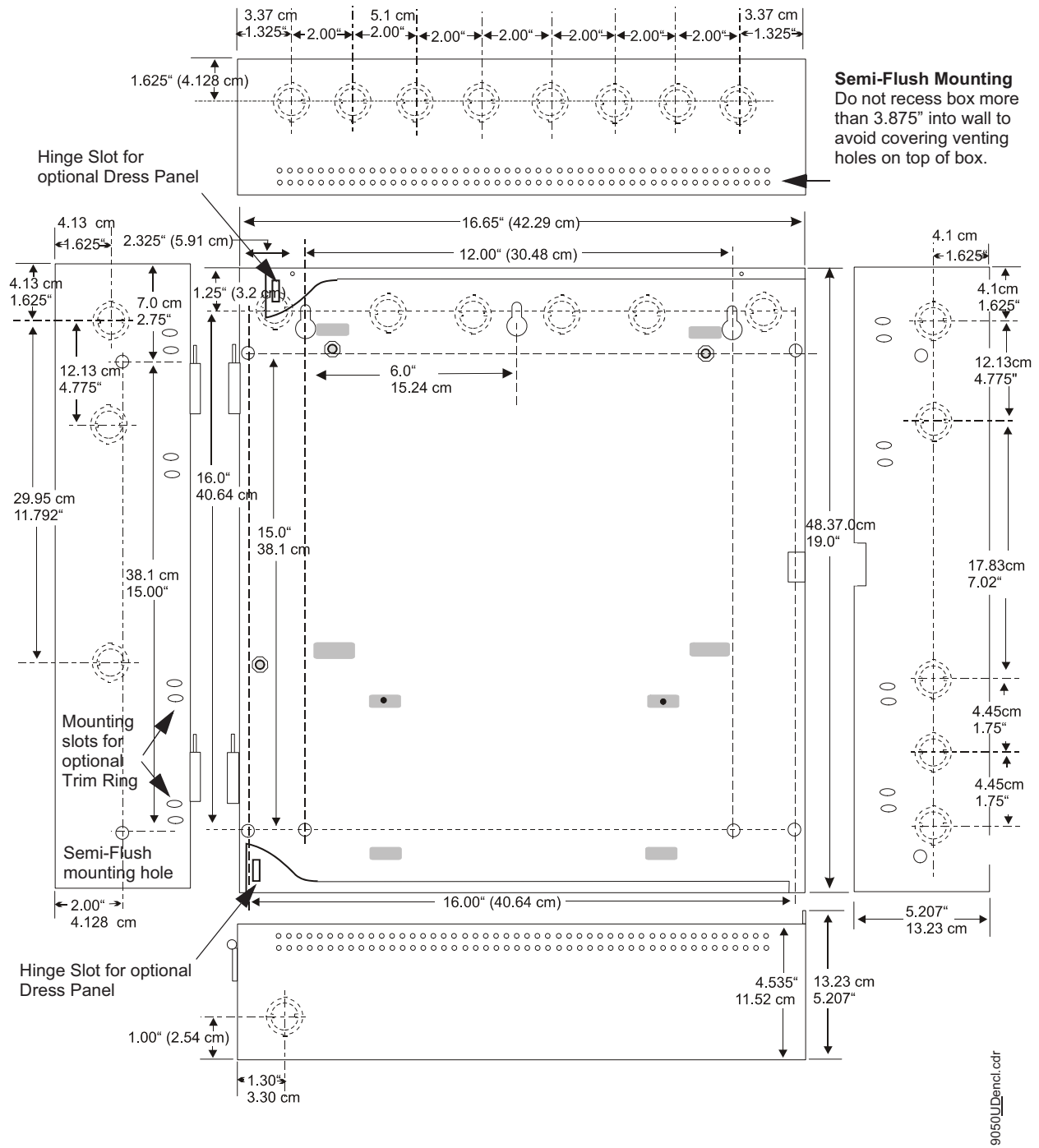

Figure 2.2 Cabinet Dimensions

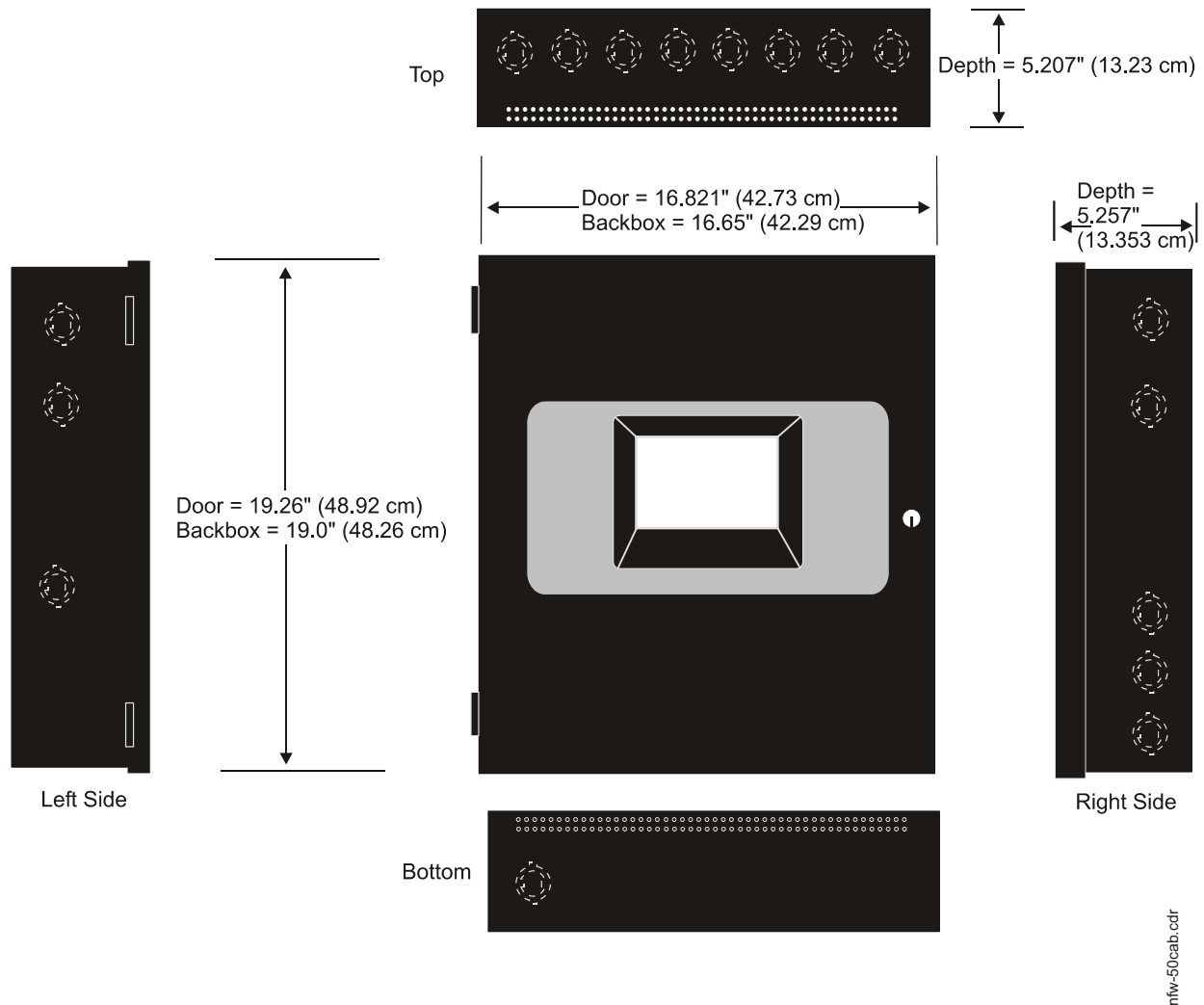

Figure 2.3 Backbox

2.2 Operating Power



CAUTION: DISCONNECT ALL POWER BEFORE SERVICING

SEVERAL DIFFERENT SOURCES OF POWER CAN BE CONNECTED TO THIS PANEL. DISCONNECT ALL SOURCES OF POWER BEFORE SERVICING. THE PANEL AND ASSOCIATED EQUIPMENT MAY BE DAMAGED BY REMOVING AND/OR INSERTING CARDS, MODULES OR INTERCONNECTING CABLES WHILE THIS UNIT IS ENERGIZED.

Primary Power Source (AC) and Earth Ground Connections

AC power connections are made inside the control panel cabinet. The primary power source for the panel is 120 VAC, 60 Hz, 3.66 amps for the RP-2001/C or 240 VAC, 50 HZ, 2.085 amps for the RP-2001E. Run a pair of wires (with ground conductor) from the protected premises main breaker box to the AC terminal block TB1 on the main power supply. As per the National Electrical Code, use 14 AWG (2.00 mm², 1.6 mm O.D.) or heavier gauge wire with 600V insulation. No other equipment may be connected to this circuit. In addition, this circuit must be provided with

overcurrent protection and may not contain any power disconnect devices. A separate Earth Ground connection must be made to ensure proper panel operation and lightning and transient protection. Connect the Earth Ground wire [minimum 14 AWG (2.00 mm²)] to the grounding stud in the backbox. *Do not use conduit for the Earth Ground connection since this does not provide reliable protection.*

Secondary Power Source (Batteries)

Observe polarity when connecting the battery. Connect the battery cable to J12 on the main circuit board using the plug-in connector and cable provided. The battery charger is current-limited and capable of charging sealed lead acid batteries. The charger shuts off when the system is in alarm.



WARNING: BATTERY CONTAINS SULFURIC ACID

BATTERY CONTAINS SULFURIC ACID WHICH CAN CAUSE SEVERE BURNS TO THE SKIN AND EYES AND CAN DESTROY FABRICS. IF CONTACT IS MADE WITH SULFURIC ACID, IMMEDIATELY FLUSH THE SKIN OR EYES WITH WATER FOR 15 MINUTES AND SEEK IMMEDIATE MEDICAL ATTENTION.

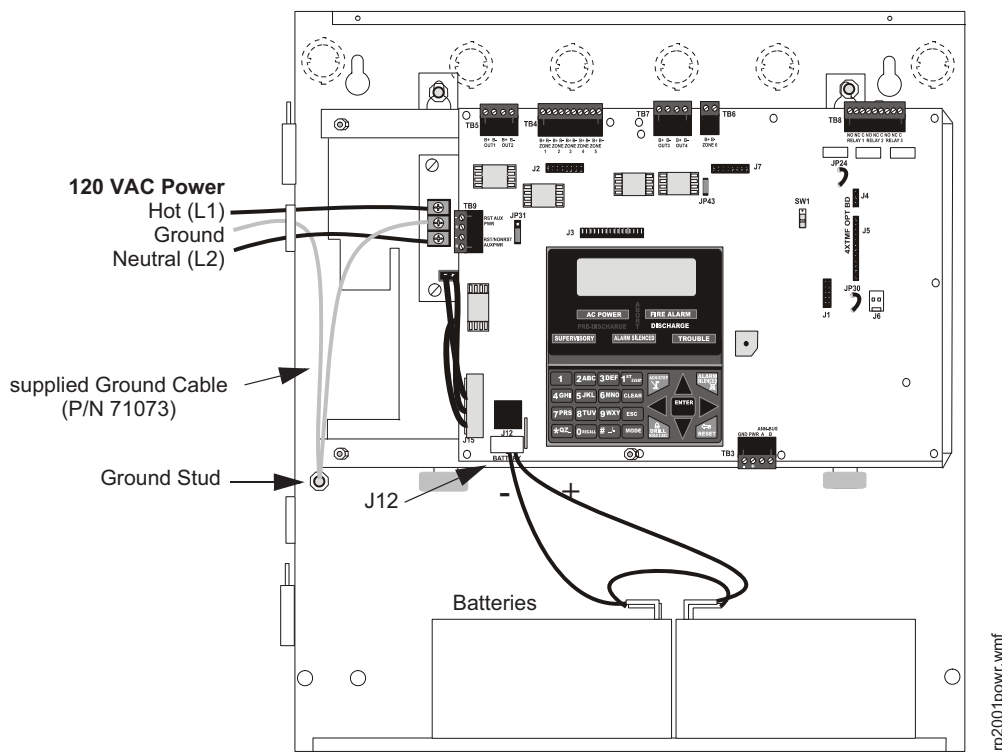

Figure 2.4 Operating Power Connections

2.3 Input Circuits

The RP-2001 has six programmable IDCs (Initiating Device Circuits). Each circuit is compatible with System Sensor’s i³ smoke detectors which generate a maintenance signal when the detector becomes dirty and a separate supervisory ‘freeze’ signal when ambient temperature falls below the detector rating of approximately 45°F. The maximum loop resistance limit for each IDC is 100 ohms (700 ohms for linear heat detection). Do not use 2-wire smoke detectors on input zones used for linear heat detection. The field wiring for each zone is supervised for opens, shorts and ground faults. All conditions are visually and audibly annunciated.

Each circuit is configured for Style B (Class B) operation and will accept i³ smoke detectors, any normally-open contact devices as well as conventional 2-wire or 4-wire, 24 VDC smoke detectors. Refer to the Device Compatibility Document for a list of compatible devices.

Initiating Device Circuits can be converted to Style D (Class A) by installing the optional Class A Converter module. Refer to “N-CAC-5X Class A Converter Module” on page 27.

Class B Initiating Device Circuits (supervised and power-limited) 4.7 KΩ, ½ watt resistor P/N:71252

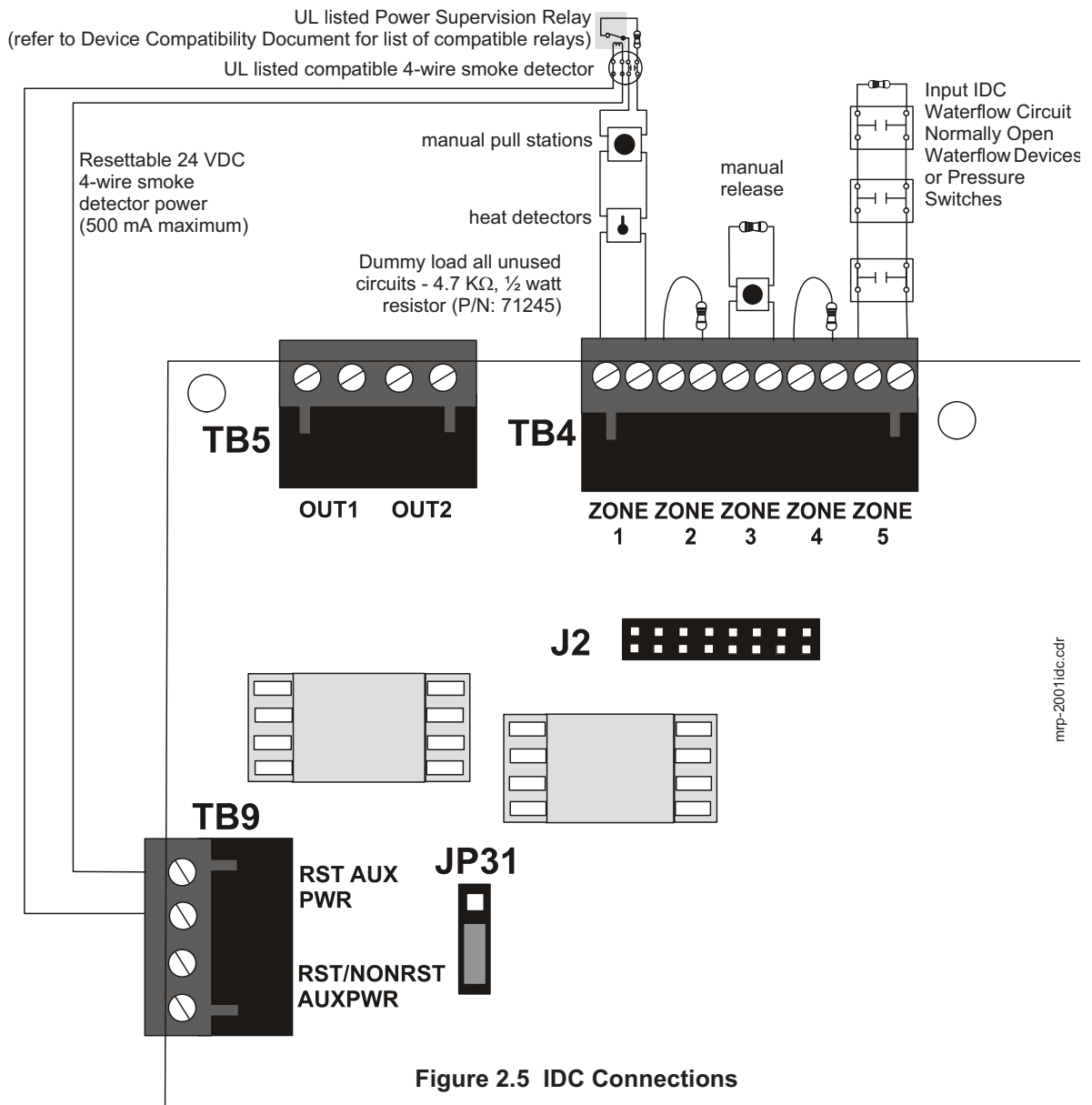

Figure 2.5 IDC Connections

Combination Waterflow/Supervisory Zone

A combination Waterflow/Supervisory circuit allows an FACP to distinguish between an Alarm switch (waterflow device) and a Supervisory switch (tamper) installed on the same circuit. Any circuit can be programmed as a Combo Type zone. The following figure illustrates the wiring of Zone 2 as a Style B (Class B) Waterflow/Supervisory circuit.

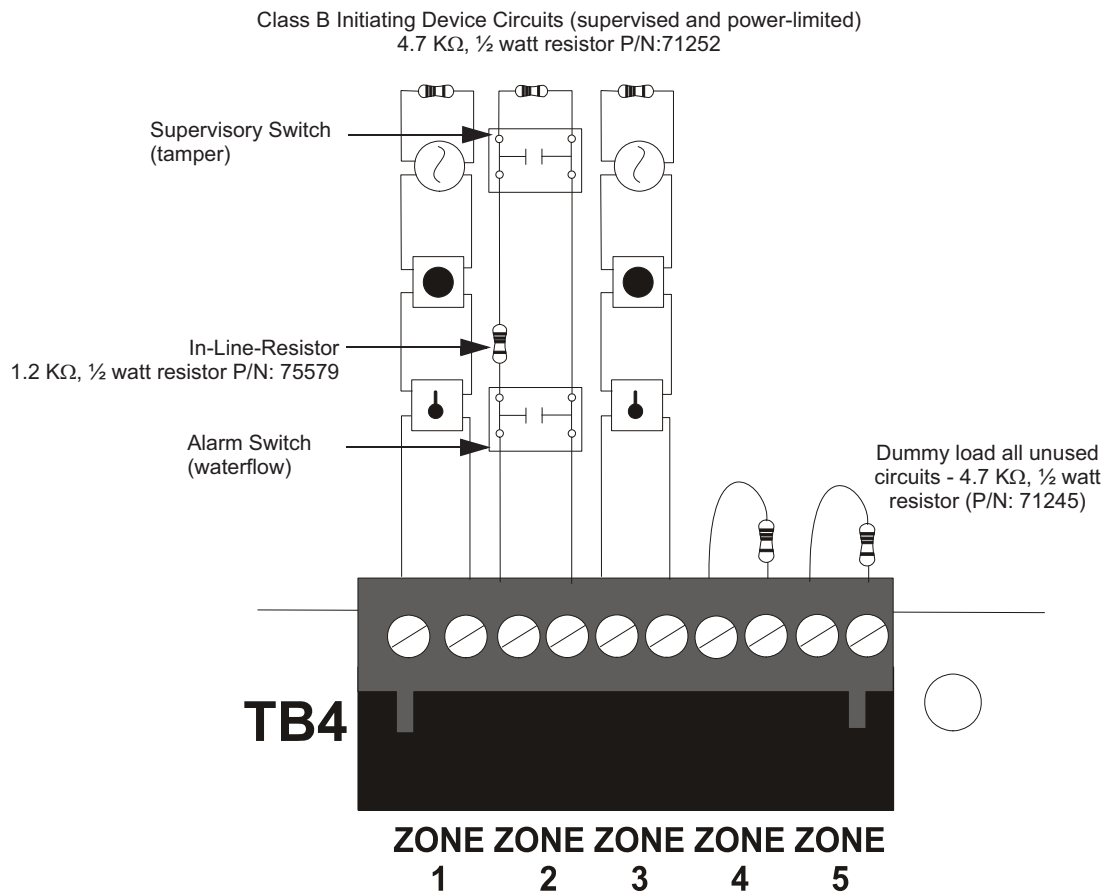

Figure 2.6 Style B Combination Circuit on Zone 2

Requirements for the Combination Waterflow/Supervisory circuit are as follows:

- ✓ This circuit is only intended for *one* Waterflow and *one* Supervisory device.
- ✓ The Waterflow Alarm Switch must connect to the FACP Initiating Device Circuit before the In-Line Resistor as shown in Figure 2.6.
- ✓ The Supervisory Switch must connect to the FACP Initiating Device Circuit after the In-Line Resistor as shown in Figure 2.6.
- ✓ Program the FACP Initiating Device Circuit as a Combination circuit as described in “Input Zones” on page 49. *Note that since a Waterflow Supervisory Switch is included in a Combination circuit, the waterflow delay must be taken into consideration. Refer to “Waterflow Delay” on page 66.*
- ✓ Waterflow Alarm Switch activation causes the panel to latch into alarm until the alarm condition is cleared and the FACP is reset
- ✓ Supervisory Switch activation causes the panel to latch the supervisory condition if the Combo type code is selected or track (the panel will clear when the supervisory condition is cleared) if the Combo Autoresettable Supervisory type code is selected.

2.4 Output Circuits

2.4.1 Outputs/Notification Appliance/Releasing Circuits

Each of the four Style Y (Class B) Notification Appliance Circuits can output a maximum of 3.0 amps of current. Total current drawn from these as well as other DC power outputs cannot exceed 7.0 amps (refer to battery calculations section). Each circuit is supervised, power-limited and provides special application power. Refer to the Device Compatibility Document for a listing of compatible notification appliances.

The NACs can be converted to Style Z (Class A) by installing two optional Class A Converter module. Refer to “N-CAC-5X Class A Converter Module” on page 27.

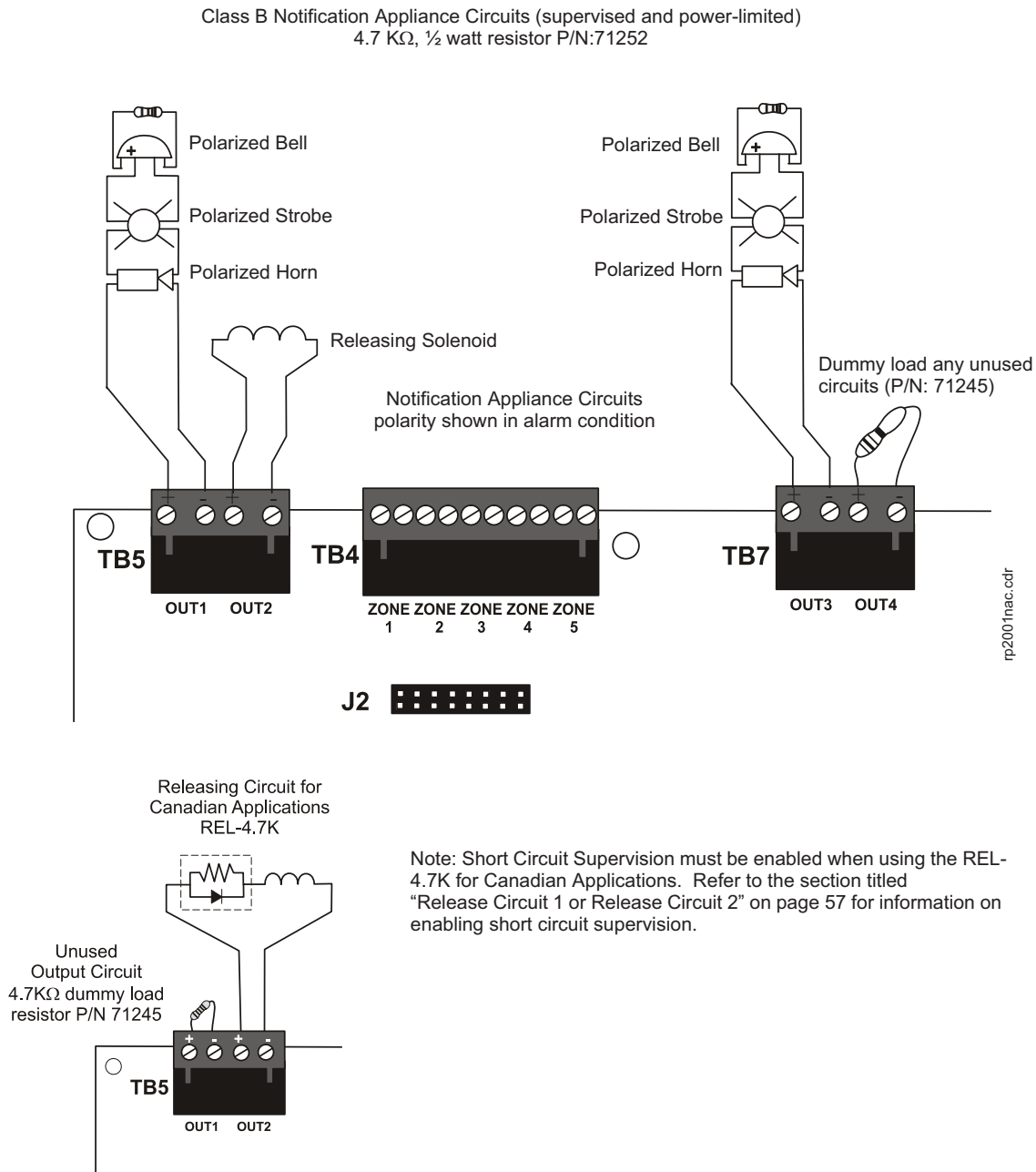

Note: Short Circuit Supervision must be enabled when using the REL-4.7K for Canadian Applications. Refer to the section titled “Release Circuit 1 or Release Circuit 2” on page 57 for information on enabling short circuit supervision.

Figure 2.7 NAC/Output Connections

2.4.2 Special Application DC Power Output Connections

Special Application Resettable and Nonresettable 24 VDC power is available on the RP-2001 control panel.

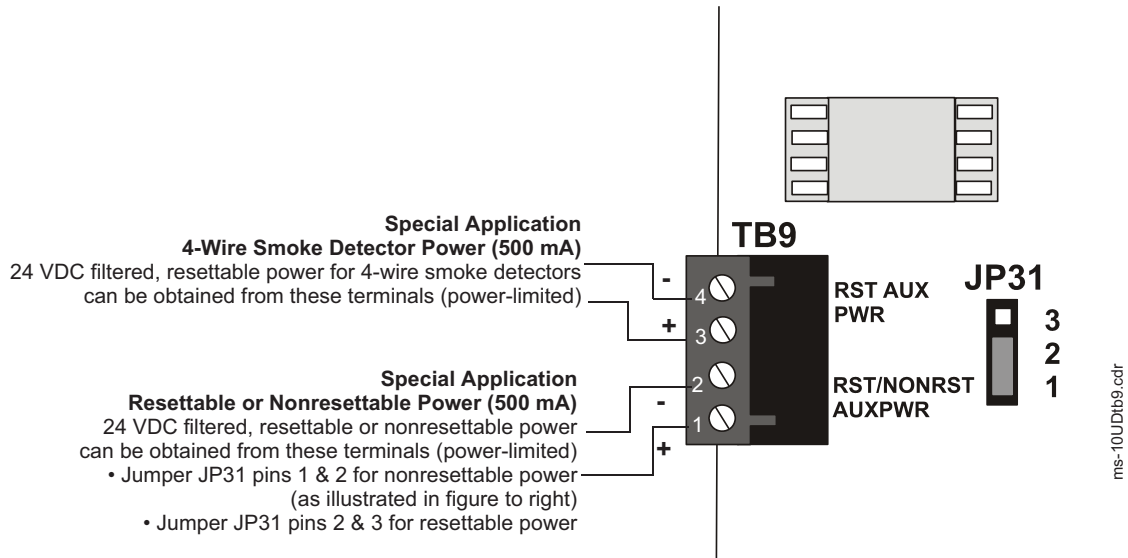

Figure 2.8 Special Application Auxiliary Power

2.4.3 Relays - Programmable

The RP-2001 control panel provides a factory default programmed alarm relay, fail-safe trouble relay and supervisory relay. Each relay can be programmed to activate for other conditions (refer to “On-Board Relays” on page 63). Each Form-C relay is rated for 2 amps @ 30VDC (resistive) and 0.5 amps @ 30 VAC (resistive).

Note that relay connections must be power-limited.

Note: Relay contacts are shown with power applied to the panel and no active troubles, alarms or supervisories. The Trouble Relay is a fail-safe relay which will transfer on any trouble or total power failure.

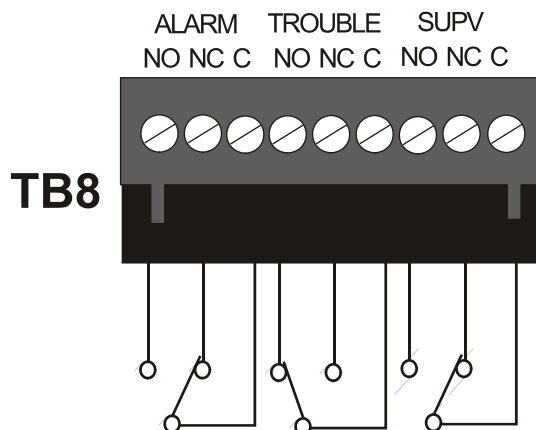

Figure 2.9 Relay Terminals

2.5 Power-limited Wiring Requirements

Power-limited and nonpower-limited circuit wiring must remain separated in the cabinet. All power-limited circuit wiring must remain at least 0.25” (6.35 mm) away from any nonpower-limited circuit wiring. Furthermore, all power-limited and nonpower-limited circuit wiring must enter and exit the cabinet through different knockouts and/or conduits. A typical wiring diagram is illustrated below.

***Note:** In certain applications, an NAC (power-limited circuit) could be adjacent to a releasing circuit (nonpower-limited without supervision kit REL-4.7K)

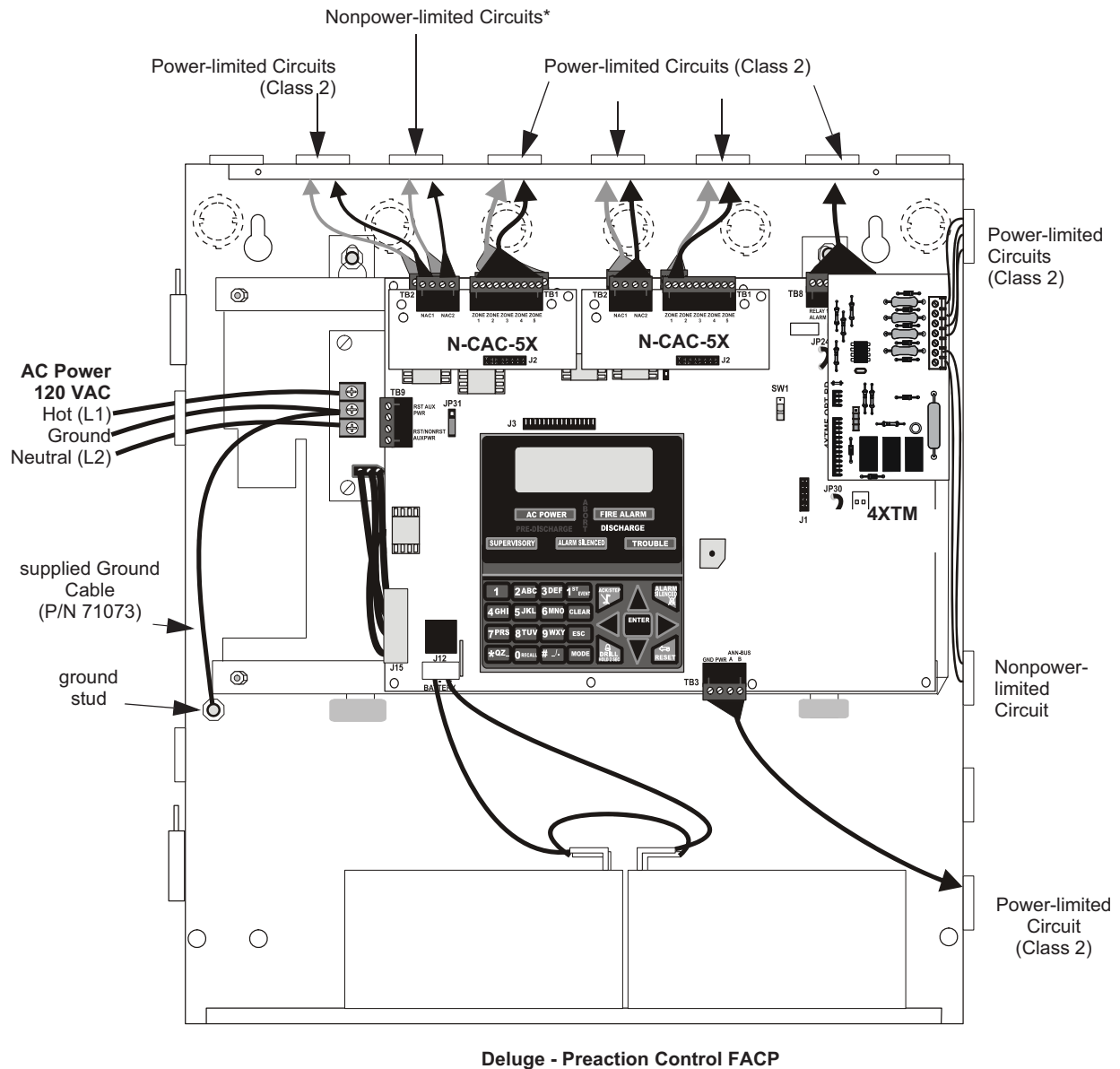

Figure 2.10 Typical UL Power-limited Wiring Requirements

RP2001ULwire.cdr

2.6 Installation of Optional Modules



CAUTION: REMOVE ALL SOURCES OF POWER
 REMOVE ALL POWER (AC AND DC) BEFORE INSTALLING OR REMOVING MODULES OR WIRING.

2.6.1 N-CAC-5X Class A Converter Module

Installation

The N-CAC-5X Module can be used to convert five Style B (Class B) Initiating Device Circuits to Style D (Class A) and the two Style Y (Class B) Notification Appliance Circuits to Style Z (Class A). Two N-CAC-5X Modules are required to convert all Output Circuits and/or Initiating Device Circuits to Class A. The modules plug into connector J2 which is located at the top left of the main circuit board and J7 which is located at the top center of the main circuit board.

To install the N-CAC-5X, remove the two main circuit board mounting screws referenced in the following illustration and replace with the two supplied male/female standoffs in the locations indicated in the following figure. Carefully align the connector on the N-CAC-5X with J2 on the FACP main circuit board and press the module securely into place. Make certain the pins are properly aligned to prevent bending or breaking of any connector pins. Secure the N-CAC-5X to the standoffs with the screws that were just removed.

To install the second N-CAC-5X on J7, remove the main circuit board mounting screw referenced in the following illustration and replace with the supplied male/female standoff. Insert the supplied plastic standoff in the location indicated in the following illustration. Carefully align the connector on the N-CAC-5X with J7 and press the module securely into place. Make certain the pins are properly aligned to prevent bending or breaking of any connector pins. Secure the N-CAC-5X to the metal standoff with the screw that was just removed.

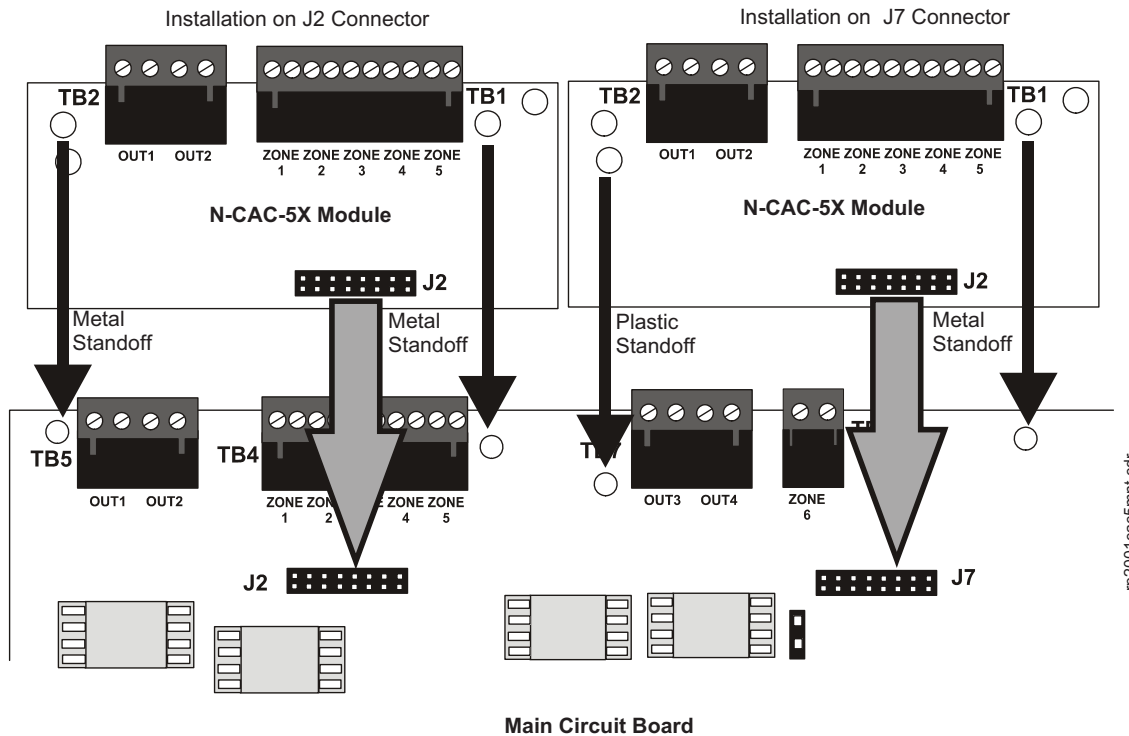

Figure 2.11 N-CAC-5X Module Installation

Wiring NACs and IDCs for Class A

Wire the Style Z (Class A) Notification Appliance Circuits using TB5 of the FACP main circuit board and TB2 of the N-CAC-5X module. Wire the Style D (Class A) Initiating Device Circuits using TB4 of the FACP main circuit board and TB1 of the N-CAC-5X. Note that the wiring will be identical when using TB7 NAC and TB6 IDC of the FACP. Make certain to observe polarity when connecting the devices to the circuits. The B+ and A+ terminals must comprise the feed and return for the positive side of a device and the B- and A- terminals must comprise the feed and return for the negative side of a device. To configure any of the zones for Class B when the N-CAC-5X is installed, simply wire to the B+ and B- input on the FACP terminal(s) and install the End-of-Line Resistor after the last device on the circuit. Do not wire to the corresponding A+ and A- terminals on the N-CAC-5X module.

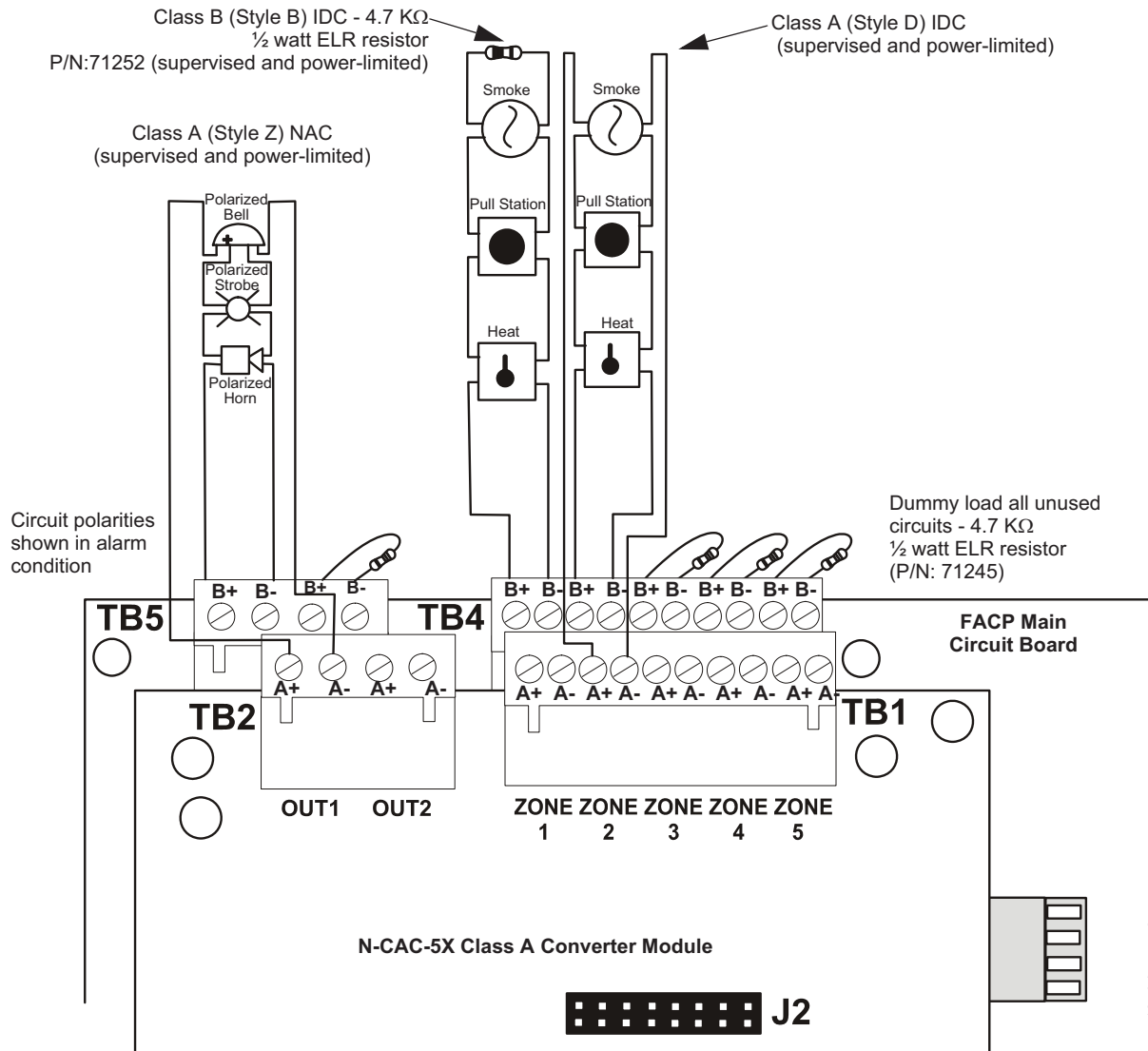

Figure 2.12 Wiring NACs and IDCs for Class A Operation

2.6.2 4XTM Municipal Box Transmitter Option Module

The 4XTM module can be plugged into connectors J4 and J5 on the main circuit board.

The following steps must be followed when installing the 4XTM module:

1. Remove all power (AC and DC) from the FACP before installing the modules
2. Cut jumper JP30 on the main circuit board to allow the control panel to supervise the placement of the 4XTM option module
3. Install the two supplied metal standoffs in the locations indicated. These standoffs provide the required earth ground protection
4. Carefully plug the connectors on the option module into connectors J4 and J5 on the FACP main circuit board, being careful not to bend any pins
5. Secure the option module to the standoff on the main circuit board with the supplied screws
6. When the installation has been completed, connect the wiring to the modules as indicated in the following sections
7. Test system for proper operation

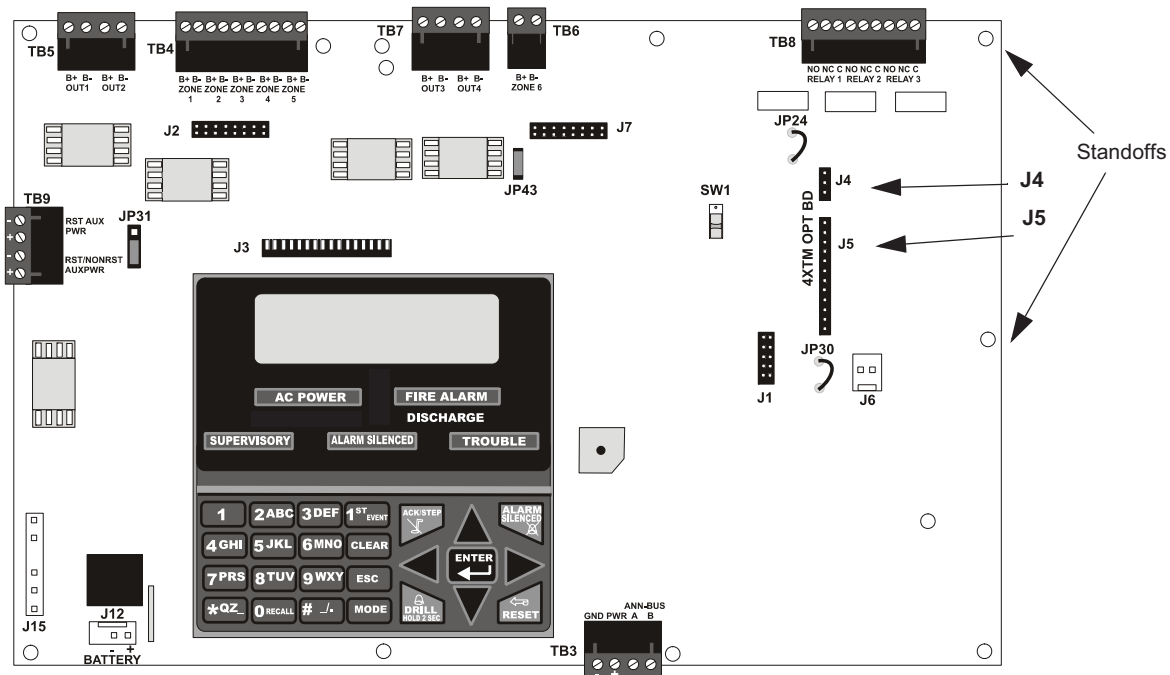

Figure 2.13 4XTM Option Module Connection

4XTM Transmitter Module Installation

The 4XTM provides a supervised output for a local energy municipal box transmitter in addition to alarm and trouble reverse polarity. A jumper option allows the reverse polarity circuit to open with a system trouble condition if no alarm condition exists. A disable switch allows disabling of the transmitter output during testing to prevent accidental calling of the monitoring service.

Local Energy Municipal Box Service (NFPA 72 Auxiliary Fire Alarm Systems):

- Supervisory Current: 5.0 mA
- Trip Current: 350 mA (subtracted from notification appliance power)
- Coil Voltage: 3.65 VDC
- Maximum Coil Resistance: 14.6 ohms
- Maximum allowable wire resistance between panel and trip coil: 3 ohms
- Municipal Box wiring can leave the building

Remote Station Service (NFPA 72 Remote Station Fire Alarm Systems) - Intended for connection to a polarity reversal circuit or a Remote Station receiving unit having compatible ratings:

- Maximum load for each circuit: 10 mA
- Reverse polarity output voltage: 24 VDC
- Remote Alarm and Remote Trouble wiring can leave the building

Before installing the module, place the disconnect switch to the down (disconnect) position to prevent accidental activation of the municipal box. Note that a Disconnect LED will illuminate after the module is installed in the FACP. In addition, the System Trouble indicator will turn on to indicate the Disconnect condition.



NOTE: The 4XTM Module is not directly suitable for transmitting reverse polarity supervisory signal. For an application using reverse polarity of a supervisory signal, refer to the Appendix titled "FACP with Keltron" on page 129.

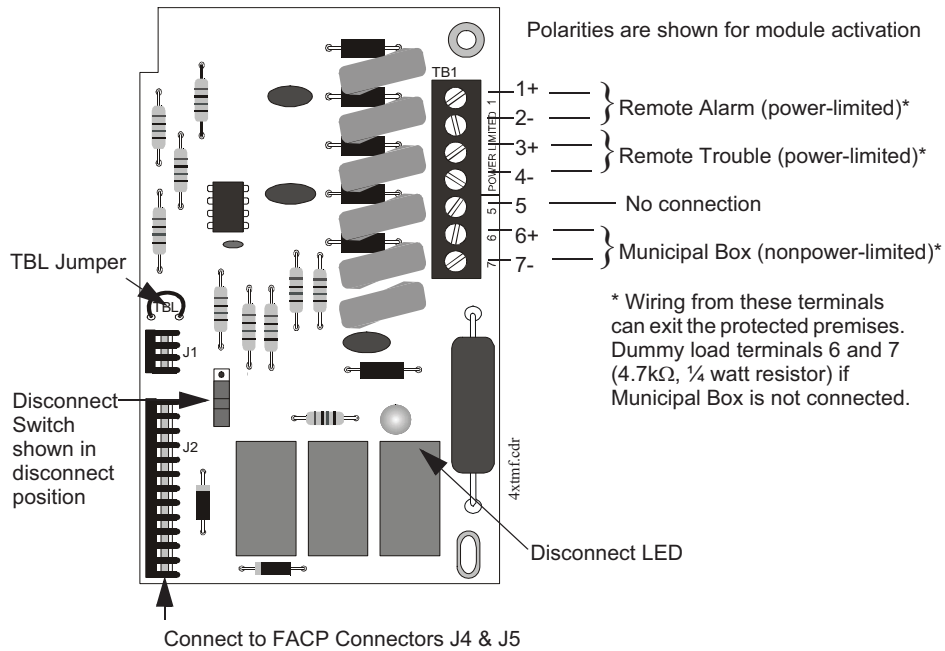

Figure 2.14 4XTM Transmitter Module

2.7 ANN-BUS Devices



WARNING: DISCONNECT ALL SOURCES OF POWER

DISCONNECT ALL SOURCES OF POWER (AC AND DC) BEFORE INSTALLING OR REMOVING ANY MODULES OR WIRING.

A variety of optional devices can be connected to the FACP ANN-BUS communication circuit.

Compatible devices include:

- N-ANN-80 LCD Annunciator
- N-ANN-S/PG Serial/Parallel Printer Interface Module
- N-ANN-I/O LED Driver Module
- N-ANN-LED Annunciator Module (annunciates alarms, troubles and supervisories)
- N-ANN-RLY Relay Module

2.7.1 ANN-BUS Wiring

This section contains information on calculating ANN-BUS wire distances and the types of wiring configurations (Class B).

Calculating Wiring Distance for ANN-BUS Modules

The following instructions will guide the installer in determining the type of wire and the maximum wiring distance that can be used with FACP ANN-BUS accessory modules.

To calculate the wire gauge that must be used to connect ANN-BUS modules to the FACP, it is necessary to calculate the total worst case current draw for all modules on a single 4-conductor bus. The total worst case current draw is calculated by adding the individual worst case currents for each module. The individual worst case values are shown in the following table:

Model Number	Worst Case Current Draw ¹
N-ANN-80 LCD Annunciator	0.040 amps
N-ANN-S/PG Serial/Parallel Printer Interface Module	0.040 amps
N-ANN-I/O LED Driver Module	0.200 amps
N-ANN-LED Annunciator Module	0.068 amps
N-ANN-RLY Relay Module	0.075 amps

¹ Total worst case current draw on a single ANN-BUS cannot exceed 0.5 amp.

After calculating the total worst case current draw, Table 2.1 specifies the maximum distance the modules can be located from the FACP on a single wire run. The table ensures 6.0 volts of line drop maximum. In general, the wire length is limited by resistance, but for heavier wire gauges, capacitance is the limiting factor.

These cases are marked in the chart with an asterisk (*). Maximum length can never be more than 6,000 feet (1,800 m), regardless of gauge used. The formula used to generate this chart is shown in the note below.

Wiring Distance: ANN-BUS Modules to FACP ¹				
Total Worst Case Current Draw (amps)	22 Gauge	18 Gauge	16 Gauge	14 Gauge
0.100	1,852 ft.	4,688 ft.	* 6,000 ft.	*6,000 ft.
0.200	926 ft.	2,344 ft.	3,731 ft.	5,906 ft.
0.300	617 ft.	1,563 ft.	2,488 ft.	3,937 ft.
0.400	463 ft.	1,172 ft.	1,866 ft.	2,953 ft.
0.500	370 ft.	938 ft.	1,493 ft.	2,362 ft.

Table 2.1 Wiring Distances

1 The following formulas were used to generate the wire distance chart:

$$\text{Maximum Resistance (Ohms)} = \frac{6.0 \text{ Volts}}{\text{Total Worst Case Current Draw (amps)}}$$

$$\text{Maximum Wire Length (feet)} = \frac{\text{Maximum Resistance (Ohms)}}{\text{Rpu}} * 500$$

(6,000 feet maximum)

where: Rpu = Ohms per 1,000 feet for various Wire Gauges (see table below)

Wire Gauge	Ohms per 1,000 feet (Rpu)
22	16.2
18	6.4
16	4.02
14	2.54

Exception: When using the N-ANN-RLY module, the installer must ensure that the maximum 24VDC power line drop does not exceed 0.3 volts. This results in the following wiring limitations:

Wire Gauge	Maximum Wire Length
18	312 feet
16	497 feet
14	787 feet
12	1,250 feet

Wiring Distance Calculation Example:

Suppose a system is configured with the following ANN-BUS modules:

- 2 N-ANN-80 Remote LCD Annunciators
- 1 N-ANN-S/PG Serial/Parallel Printer Interface Module
- 1 N-ANN-I/O LED Driver Module

The total worst case current is calculated as follows:

N-ANN-80 Current Draw	= 2 X 0.040 amps	= 0.080 amps
N-ANN-S/PG Current Draw	= 1 X 0.040 amps	= 0.040 amps
N-ANN-I/O Current Draw	= 1 X 0.200 amps	= 0.200 amps
Total Worst Case Current Draw		= 0.320 amps

Using this value and referring to the Wiring Distance Table 2.1 on page 32, it can be found that the available options are:

- ✓ 463 feet maximum using 22 Gauge wire
- ✓ 1,172 feet maximum using 18 Gauge wire
- ✓ 1,866 feet maximum using 16 Gauge wire
- ✓ 2,953 feet maximum using 14 Gauge wire

Wiring Configuration

Figure 2.15 illustrates the wiring between the FACP and ANN-BUS devices.

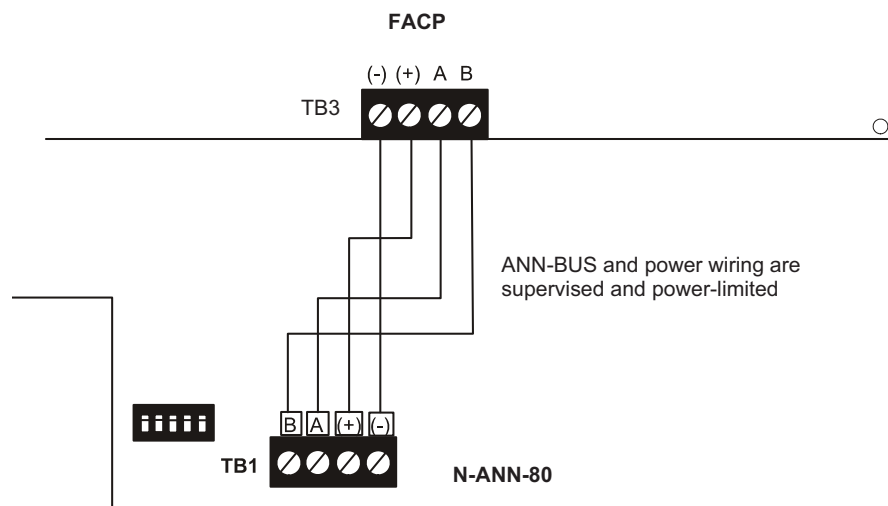

Figure 2.15 FACP wiring to ANN-BUS Device

Powering ANN-BUS Devices from Auxiliary Power Supply

Figure 2.16 illustrates the powering of ANN-BUS devices from an auxiliary power supply such as the FCPS-24S6/8, when the maximum number of ANN-BUS devices exceeds the ANN-BUS power requirements.

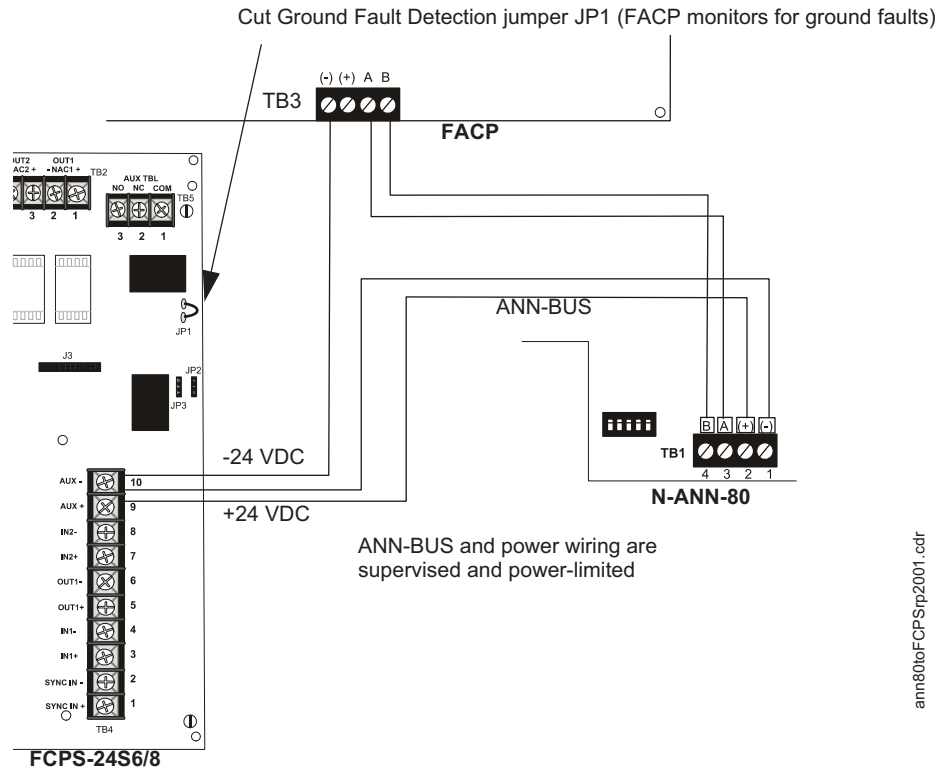

Figure 2.16 Powering ANN-BUS Devices from FCPS-24S6/8

2.7.2 ANN-BUS Device Addressing

Each ANN-BUS device requires a unique address (ID Number) in order to communicate with the FACP. A 5-position DIP switch on each device is used to set this address. The address set for these devices must also be programmed at the FACP for the specific device (refer to the programming section titled “ANN-BUS” on page 71).

A maximum of 8 devices can be connected to the FACP ANN-BUS communication circuit. Device addresses do not need to be sequential and can be set to any number between 01 and 08. Note that 00 is not a valid address. The following table shows the DIP switch setting for each address.



NOTE: address (ID Number) DIP switches on some devices may have more than 5 switch positions. Unless otherwise specified in the documentation supplied with each device, switch positions 6 and above must be set to **OFF**.

Address	Switch 5	Switch 4	Switch 3	Switch 2	Switch 1
not valid	OFF	OFF	OFF	OFF	OFF
01	OFF	OFF	OFF	OFF	ON
02	OFF	OFF	OFF	ON	OFF
03	OFF	OFF	OFF	ON	ON
04	OFF	OFF	ON	OFF	OFF
05	OFF	OFF	ON	OFF	ON
06	OFF	OFF	ON	ON	OFF
07	OFF	OFF	ON	ON	ON
08	OFF	ON	OFF	OFF	OFF

2.7.3 N-ANN-80 Remote LCD Annunciator

The N-ANN-80 LCD Annunciator is a compact, 80 character, backlit LCD remote fire annunciator which mimics the FACP display. It also provides system status indicators for AC Power, Alarm, Trouble, Supervisory and Alarm Silenced conditions. Communication between the N-ANN-80 and FACP is accomplished over a two wire serial interface employing the ANN-BUS communication format. The devices are powered, via two additional wires, from either the host FACP or remote UL-listed, filtered, power supply.

2.7.4 Specifications

- Operating Voltage Range: 18 VDC to 28 VDC
- Current Consumption @ 24 VDC nominal (filtered and nonresettable):
 - ✓ Normal/Standby (no activity): 37.0 mA
 - ✓ Trouble: 39.0 mA
 - ✓ Alarm: 40.0 mA
 - ✓ AC Fail (not backlit): 15.0 mA
- For use indoors in a dry location

2.7.5 Installation

Ensure that all power (AC and DC) has been removed from the FACP before installing the annunciator.

Mounting

The N-ANN-80 can be surface mounted using the optional ANN-SB80KIT-B (black) or ANN-SB80KIT-W (white) surface mounting box or semi-flush mounted to a single, double or 4" square electrical box. Select and remove the appropriate knockout(s), pull the necessary wires through the knockouts and mount the annunciator in or on the wall depending on the type of installation desired.

The N-ANN-80 cover must be attached to the annunciator backplate before mounting the annunciator to the electrical box/wall. The cover cannot be reattached or removed after the annunciator has been mounted.

Opening/Closing Annunciator

The following procedure details the steps used to open the annunciator in order to access the terminal block and DIP switches (refer to figure below):

1. Turn the key switch to the ON (Unlocked) position by turning the key counter-clockwise
2. Push in the snap latch located on the right side of the unit while pulling the cover open
3. To close the cover, make certain the key switch is in the ON (Unlocked) position. Swing the cover closed, snapping it shut

- Turn the key switch to the OFF (Locked) position by turning clockwise and remove the key

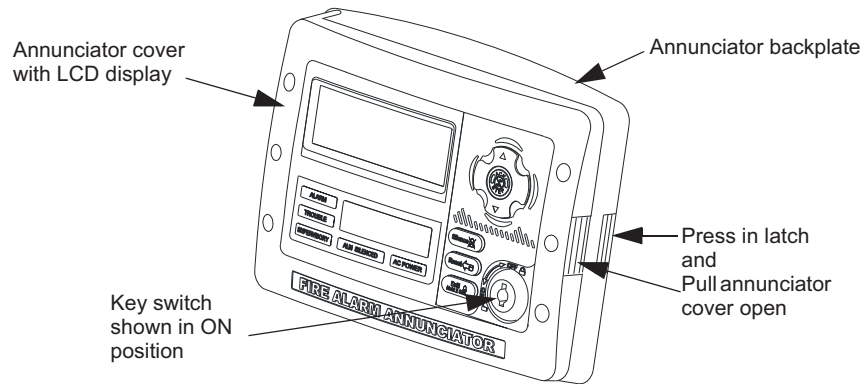

Wiring N-ANN-80 to FACP

The following steps can be used as a guide to wire the annunciator. Make certain all power has been removed from the FACP prior to annunciator installation.

- Route wires from hole in backplate, through wiring channel and then to N-ANN-80 terminal block TB1.

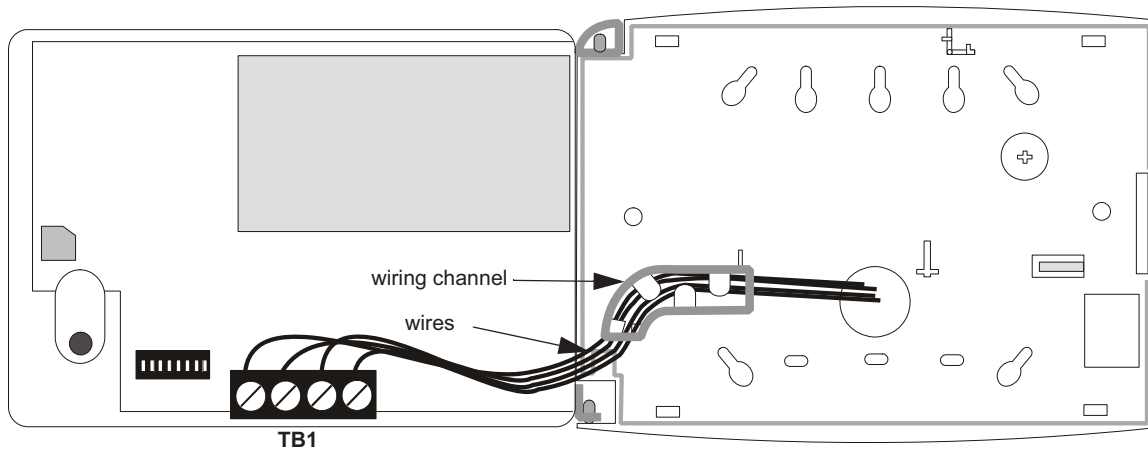

- Remove appropriate amount of wire insulation.
- Connect the wiring from the FACP ANN-BUS to annunciator TB1 terminals 3 (A) & 4 (B). Make certain to connect A to A and B to B.
- If appropriate, connect the wiring going to the next device on the ANN-BUS to TB1 terminals 3 & 4. Make certain to connect A to A and B to B.
- Connect the wiring from the 24 VDC power source to annunciator TB1 terminals 1 (-) & 2 (+). Make certain to observe proper polarity.
- If appropriate, connect the power wiring going to the next device to terminals 1 (-) & 2 (+). Make certain to observe proper polarity.
- After all connections are made, remove extra wire from inside annunciator by dressing it neatly through wire channel, with any excess wire pushed back through hole into electrical box.

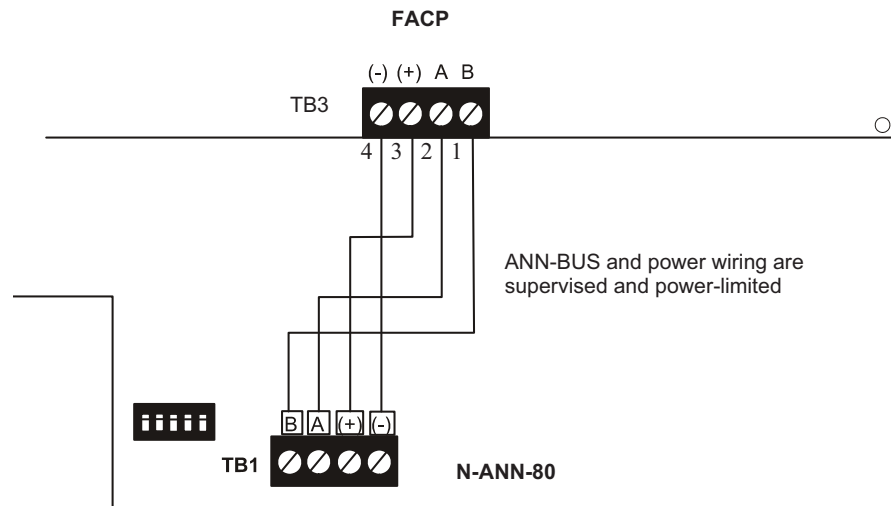

Figure 2.17 N-ANN-80 Wiring to FACP

The following table shows the N-ANN-80 connections to the FACP.

FACP (TB3)	N-ANN-80 (TB1)
Terminal 4 GND (-)	Terminal 1 (-)
Terminal 3 PWR (+)	Terminal 2 (+)
Terminal 2 A (ANN-BUS)	Terminal 3 (A)
Terminal 1 B (ANN-BUS)	Terminal 4 (B)

Programming

Following installation and wiring of the N-ANN-80 LCD annunciator to the FACP, the annunciator must be added to the system via FACP programming. Refer to the programming section titled “ANN-BUS” on page 71 in this manual for detailed programming information. Select the LCD option for programming.

2.7.6 N-ANN-S/PG Serial/Parallel Printer Interface Installation

The N-ANN-S/PG Serial/Parallel Interface module allows the ancillary connection of a serial or parallel printer to the FACP for a real-time log of system events, detector status reports and event history. Note that either a serial or parallel printer may be installed, not both. Proceed with the installation as described in the following:

1. Ensure that all power (AC and DC) has been removed from the FACP.

2. Connect the N-ANN-S/PG to the FACP as illustrated in Figure 2.18

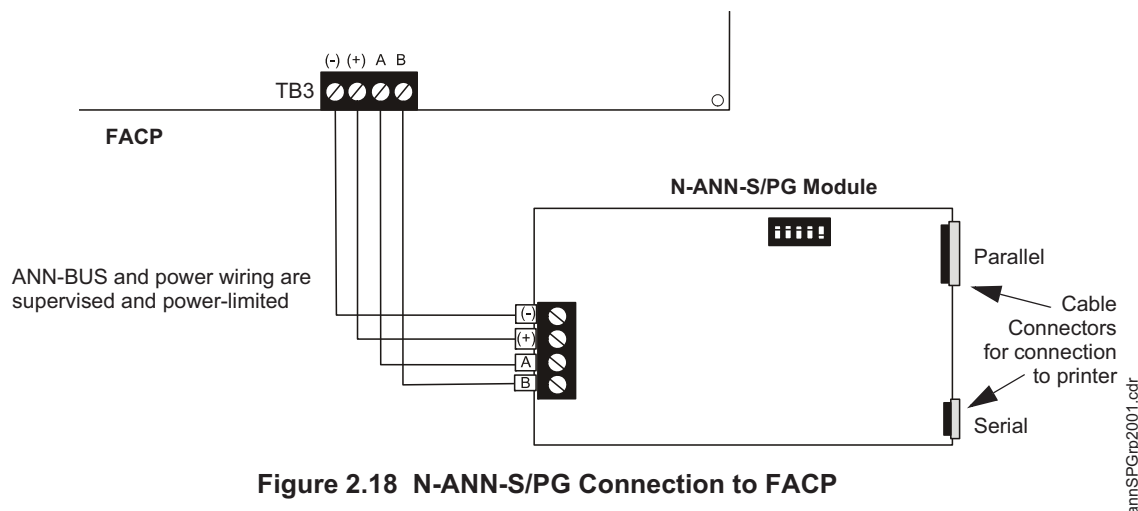

Figure 2.18 N-ANN-S/PG Connection to FACP

3. Using the DIP switches on the back of the N-ANN-S/PG module, assign an ID number (address) to the module
4. Select the address and configuration options for the N-ANN-S/PG module as described in the Programming section of this manual (refer to “ANN-BUS” on page 71)
Note that the Auto-configure feature allows the programmer to quickly bring all installed ANN-BUS modules online (refer to “Auto-Configure” on page 72)
5. Connect a printer to the N-ANN-S/PG Parallel or Serial connector (refer to Figure 2.18 on page 38)

Specifications

- Operating Voltage: 24 VDC
- Current (Alarm and Standby): 45 mA
- Ambient Temperature: 32°F to 120°F (0°C to 49°C)
- Max. Wiring Distance from FACP: 6,000 ft. (1,800 m)
- Mounting: Surface
- Dimensions: 6”W x 7-3/4”H x 1-7/16”D (15.2 cm W x 19.7 cm H x 3.7 cm D)
- For indoor use in a dry location only

PRN-6 Printer Installation

When connected to the FACP via the N-ANN-S/PG module, the PRN-6 prints the status changes within the control panel and time-stamps the printout with the time of day and date that the event occurred. It provides 80 columns of data on standard 9” x 11” tractor-feed paper. This section contains information on connecting a printer to the control panel and setting the printer options.

■ Connecting PRN-6 Printer

Remote printers require a primary AC power source. If required for the fire alarm system configuration (for example, a Proprietary Fire Alarm System), a remote printer requires a secondary power source (battery backup). Since a secondary power source is not provided as a standard feature, a separate UL-listed Uninterruptible Power Supply (UPS) should be used. The building emergency power supply may be used, as long as it meets the power continuity requirements of NFPA 72. Refer to NFPA 72 for further details.

Connect the remote printer to the FACP via the N-ANN-S/PG module using a standard DB-25 cable. One end of the cable will plug into the DB-25 connector on the PRN-6 printer and the other end plugs into the parallel connector on the N-ANN-S/PG module. Note that the 9-pin DB-9 port on the N-ANN-S/PG is used to connect a serial printer. The 25-pin port is used for a Centronics parallel printer cable. Connect either a serial or parallel printer, but not both at the same time.

■ Setting Printer Options

Refer to the documentation supplied with the PRN-6 printer for instructions on using the printer menu controls. Set the printer options (under the menu area) as shown in the following table:

Option	Setting	Option	Setting
Font	HS Draft	CPI	10CPI
LPI	6 LPI	Skip	0.5
ESC Character	ESC	Emulate	Epson FX-850
Bidirectional Copy	ON	I/O	
CG-TAB	Graphic	Buffer	40K
Country	E-US ASCII	Serial	
Auto CR	OFF	Baud	9600 or 2400
Color Option	Not Installed	Format	7 Bit, Even, 1 Stop
Formien		Protocol	XON/XOFF
Lines	6LPI=60	Character Set	Standard
Standard	Exec 10.5	Sl.Zero	On
		Auto LF	On
		PAPER	
		BIN 1	12/72"
		BIN 2	12/72"
		SINGLE	12/72"
		PUSH TRA	12/72"
		PULL TRA	12/72"
		PAP ROLL	12/72"

Table 2.2 PRN-6 Setup Options

2.7.7 N-ANN-I/O LED Driver Module

The N-ANN-I/O is an LED driver module that can be used in a wide variety of applications, including as an interface with most customized graphic annunciators. The N-ANN-I/O can drive up to 40 LEDs. The following sections describe hardware installation. Refer to the section titled "ANN-BUS" on page 71 for programming information.

N-ANN-I/O Board Layout

Figure 2.19 illustrates the N-ANN-I/O board showing locations of screw terminals for connection to the FACP, pin connectors for connecting LEDs and the DIP switch for selecting the ANN-BUS ID number.

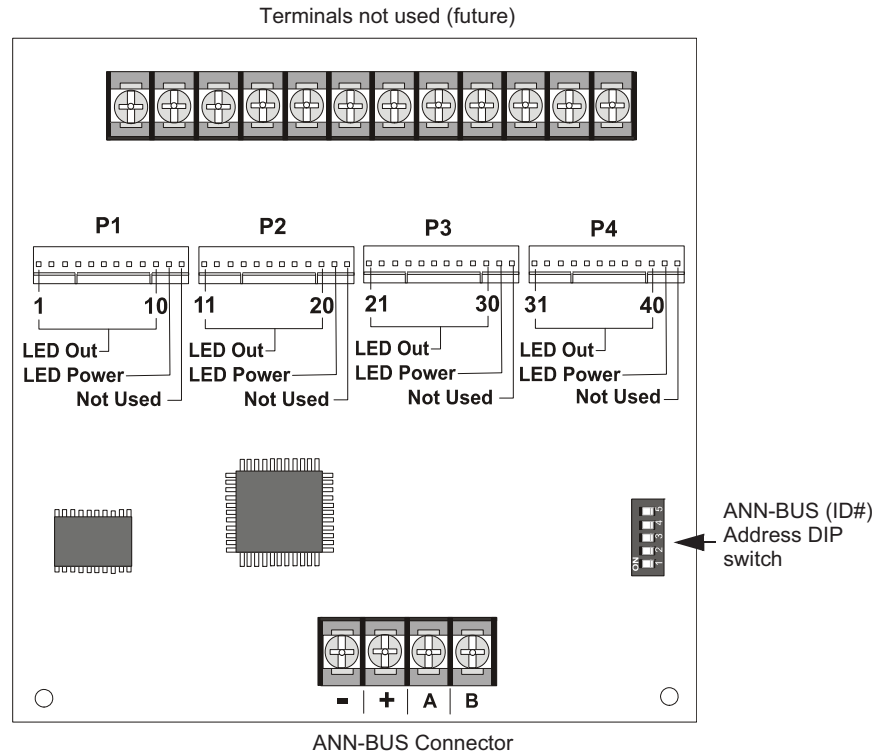

Figure 2.19 N-ANN-I/O Board Layout

2.7.8 Specifications

- Max. ANN-BUS Voltage: 28 VDC
- Max. Current:
 - ✓ Alarm: 200 mA
 - ✓ Standby: 35 mA
 - ✓ Each LED: 10 mA
- Operating Temperature: 32°F to 120°F (0°C to 49°C)
- For indoor use in a dry location only

N-ANN-I/O Connection to FACP

The N-ANN-I/O connects to the FACP via the ANN-BUS as illustrated in Figure 2.20. After the N-ANN-I/O is connected to the panel, it must be added to the system via FACP programming.

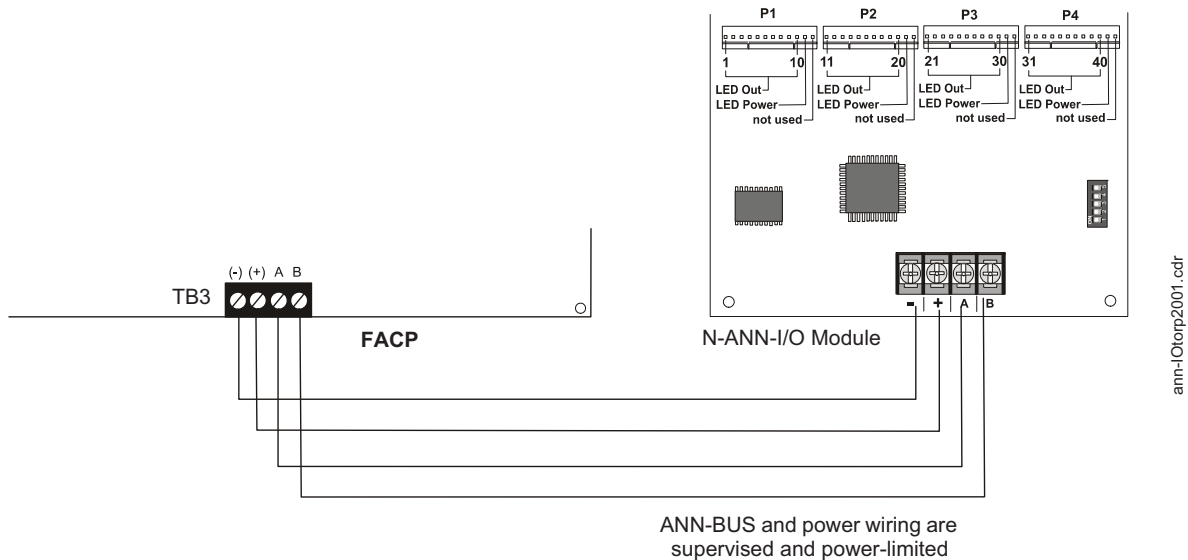

Figure 2.20 N-ANN-I/O Connection to FACP

N-ANN-I/O Module LED Wiring

There are four 12-pin connectors on the N-ANN-I/O module for connecting LEDs. Each set of 10 LEDs get their power from Pin 11 of the corresponding connector. Internal resistors are sized so that there is approximately 10 mA of current for each LED. No series resistors are required. LED outputs are mapped to output circuits. Refer to the section titled “N-ANN-I/O LED Zone Assignments” on page 74 of this manual.

The LEDs are wired as illustrated in Figure 2.21. Note that the illustration depicts only connectors P1 and P2. Wiring is identical for P3 (LEDs 21-30) and P4 (LEDs 31-40).

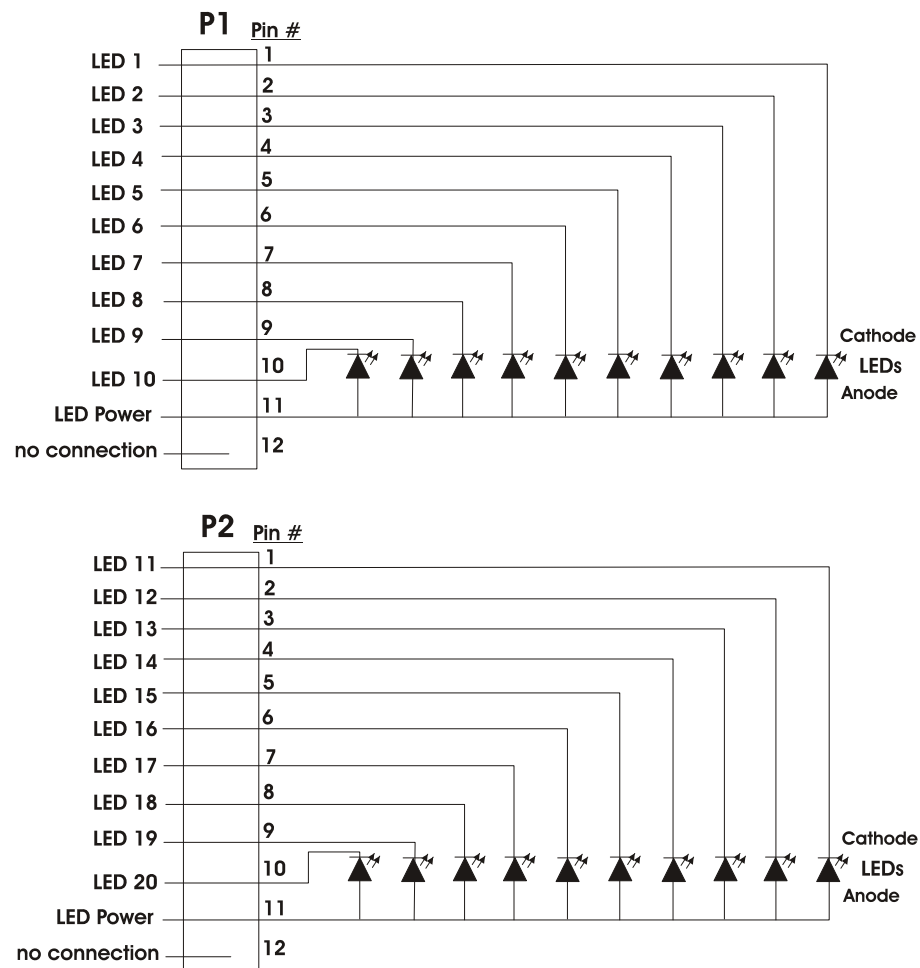

Figure 2.21 N-ANN-I/O LED Wiring

2.7.9 N-ANN-LED Annunciator Module

The N-ANN-LED annunciator modules provide LED annunciation of general system faults and input zones when used with a compatible FACP. The N-ANN-LED module provides alarm (red), trouble (yellow) and supervisory (yellow) indication for up to ten input zones.

Canadian Applications: The N-ANN-LED is supplied standard with the Canadian version of the FACP. It is mounted to the dress panel included with this model.

Specifications

- Max. ANN-BUS Voltage: 24 VDC
- Max. Current:
 - ✓ Alarm: 68 mA
 - ✓ Standby: 28 mA
- Operating Temperature: 32° F to 120° F (0° C to 49° C)
- For indoor use in a dry location only

Mounting/Installation

Install the N-ANN-LED Module as described in the documentation supplied with the annunciator.

N-ANN-LED Board Layout and Connection to FACP

Figure 2.22 illustrates the N-ANN-LED board showing locations of screw terminals for connection to the FACP and the DIP switches for selecting the ANN-BUS ID number.

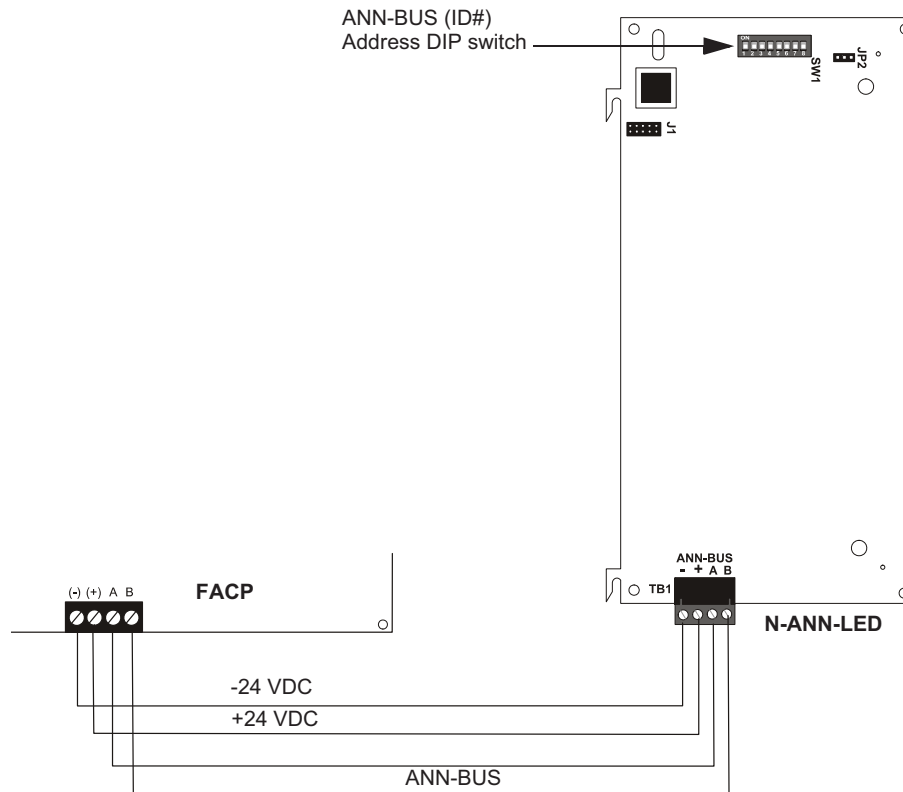

Figure 2.22 N-ANN-LED Board Layout and Connection to FACP

2.7.10 N-ANN-RLY Relay Module

The N-ANN-RLY relay module provides 10 programmable Form-C relays when used with a compatible FACP.

Specifications

- Operating Voltage: 24 VDC
- Max. Current:
 - ✓ Alarm: 75 mA
 - ✓ Standby: 15 mA
- Relay Contact Ratings:
 - ✓ 2.0 amps @ 30 VDC (resistive)
 - ✓ 0.5 amps @ 30 VAC (resistive)
- Operating Temperature: 32° F to 120° F (0° C to 49° C)
- For indoor use in a dry location only

Mounting/Installation

The N-ANN-RLY relay module can be mounted inside the FACP main circuit board chassis. An optional ANN-MBRLY mounting bracket allows mounting of the N-ANN-RLY in the lower right hand corner of the FACP cabinet instead of or in conjunction with the mounting provisions under the main FACP circuit board chassis. Refer to the documentation supplied with the module for information on installation.

N-ANN-RLY Board Layout and Connection to FACP

Figure 2.22 illustrates the N-ANN-RLY board showing locations of screw terminals for connection to the FACP and the DIP switches for selecting the ANN-BUS ID number.

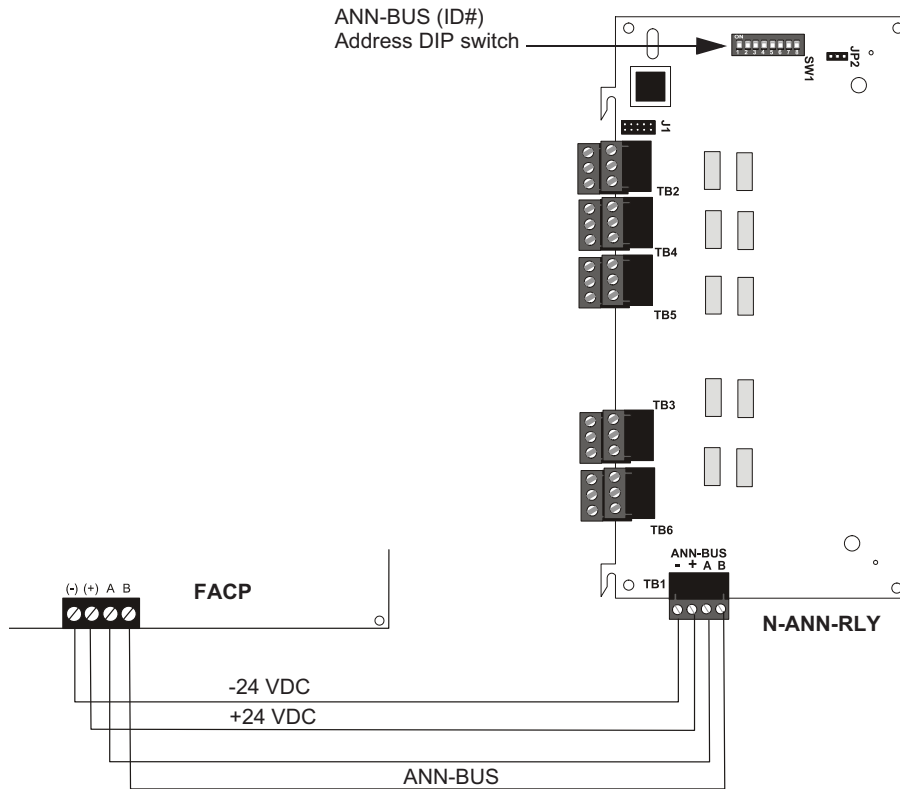

Figure 2.23 N-ANN-RLY Board Layout and Connection to FACP

Section 3: Programming

NOTICE TO USERS, INSTALLERS, AUTHORITIES HAVING JURISDICTION AND OTHER INVOLVED PARTIES			
This product incorporates field-programmable software. In order for the product to comply with the requirements in the Standard for Control Units and Accessories for Fire Alarm Systems, UL 864, certain programming features or options must be limited to specific values or not used at all as indicated below.			
Program feature or option	Permitted in UL 864? (Y/N)	Possible settings	Settings permitted in UL 864
N-ANN-80 Lock Enable	Y	Lock Enable Yes Lock Enable No Refer to Lock Enable in “ANN-80 Options” on page 75	Lock Enable Yes
Combo	Y	Refer to Table 3.1 on page 51.	One Waterflow and one Supervisory device
Combo w/AutoResettable Superv	Y	Refer to Table 3.1 on page 51.	One Waterflow and one Supervisory device

3.1 User Programming

The FACP is completely field programmable using the panel keypad and requires no special software skills. *While programming the FACP, the fire protection capabilities of the control panel are enabled. Programming Mode times-out after 10 minutes of inactivity.*

Program Templates have been provided to allow the panel to be quickly programmed with typical job-site configurations. Refer to “Circuit Mapping and Cross-Zoning” on page 102 for an explanation of mapping and cross-zoning and “FACP Configuration Templates” on page 107 for a detailed description of each template.

Site-specific programming may be accomplished:

- by Manual programming or editing, using the FACP keypad

The *System All Normal* screen will be displayed in a programmed system with no active alarms, troubles or supervisories, as illustrated below:

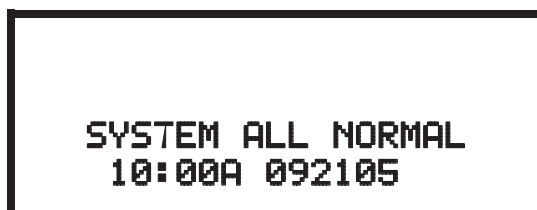

Read Status mode can be entered while the panel is in any mode of operation. If an alarm or supervisory event exists at the panel, the event must be cleared before entering Programming mode. *The exception to this is the programmer/operator can access Programming mode if the supervisory is due to the **Disable Release** event. Refer to Table 3.1 on page 51.*

To access any of the programming or read status features, the *Enter* or *Mode* key must be pressed, which will cause the LCD to display the following:



Pressing *1*, while this screen is being displayed, will cause the control panel to enter the Read Status Mode which allows the user to view the programmed features and status of the control panel. The Read Status feature is not password protected. Refer to “Read Status” on page 91 for a detailed description of this feature.

Pressing *2* will select user Programming Mode which may only be accomplished by an authorized person. After pressing *2*, a screen will prompt for a password. After entering the correct password, the user may select from a list of programming options.

Exit Programming and Read Status Mode

The programmer can exit any mode by repeatedly pressing the keypad *ESC* (Escape) key until the display reads System All Normal. Ten minutes of inactivity will also cause the panel to exit Programming Mode. *Note that the data which is entered during Programming mode is automatically saved by the panel as soon as the data is entered. If the Reset key is pressed or power is lost before exiting Programming mode, all data just entered will not be lost.*

User Programming Levels

There are two user programming levels:

- User Master Program Level 1 is used for programming panel specific data relating to device types, zoning, messages, control panel functions, etc.
- User Maintenance Program Level 2 is used by a qualified operator to access features such as Disable/Enable, View and Clear History, Walktest and System Time Change.

3.2 Initial Power-up

The following sections describe the initial programming procedures for a new system. The same procedures are used to modify programming in an existing system.

After completing the wiring of devices to the FACP, apply power to the control panel. If wiring has not been completed and/or End-of-Line resistors are not installed at the panel, a trouble condition will be indicated at the panel and a trouble message will be displayed on the LCD. Following is an example of a possible trouble message that may be displayed.



```
OPEN PULL STATION
ZONE 1 OPEN FAULT
09:03A 012106
```

3.3 Programming Screens Description

Two options are available when the *Enter* key is pressed: Read Status and Programming Mode. The Read Status and Programming options have multiple functions or features which may be chosen. To view all of the choices, it is necessary that the programmer scroll through a number of additional *subscreens*. These selections are displayed on multiple screens to make them more readable for the programmer. Refer to “Master Programming Level” on page 48, for additional information on the various screens.

The title of the main option screen will always be displayed at the top of the subscreens for the programmer’s convenience. If additional subscreens exist, an Up or Down arrow will be displayed in the upper right corner of the screen being viewed. The programmer can then press the keypad Up or Down arrow key to view the new subscreen. To select one of the choices in a screen, the programmer presses the keypad numerical key corresponding to the desired choice.

Note that subscreens may also have multiple options which require viewing more than one screen. The same process, as detailed in the previous paragraphs, is followed to view all option choices.

3.4 Programming and Passwords

There are two factory set programming passwords which will access the Programming screens as indicated in the following examples. From either of the screens, access to specific system and device features or programming may be obtained. All user programming entries are stored in nonvolatile memory. The factory set passwords can be changed by the user as described in "Password Change" on page 79. If an invalid password is entered, the blinking cursor will return to the first password character position. To exit Programming or Read Status mode at any time, press the ESC (Escape) key repeatedly. Note that as soon as program data is entered, the data is automatically saved by the panel. If the *Reset* key is pressed or power is lost before exiting Programming mode, the data just entered will not be lost.

To access user Programming mode, press the *Enter* or *Mode* key. The LCD will display the following:



To enter the user Programming mode, press 2. The display will read as follows:



Entering the Master level password (default 00000) will cause the following screen to appear:

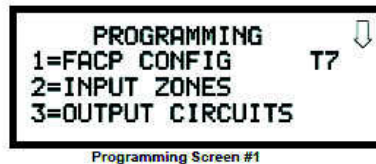

If the Maintenance level password (default 11111) is entered, the following screen will appear:



Note that in the two preceding screens, an arrow appears to inform the programmer that additional options can be viewed by pressing the keypad *down* arrow key.

3.5 Master Programming Level

When the Master Program Level password is entered, the control panel will enter user Programming mode. In this mode, the piezo sounder remains off, the trouble relay is activated and the system Trouble indicator flashes until Programming mode is exited. The following display will appear:



Programming Screen #1

The down arrow which appears in the display indicates that additional programming choices can be viewed by pressing the down arrow key on the keypad. If a down and up arrow appear in the display, pressing the 'down' arrow key will display the subsequent Programming Screens as illustrated below while pressing the 'up' arrow key will display the previous screen.



Programming Screen #2



Programming Screen #3



Programming Screen #4

3.5.1 FACP CONFIG (Application Templates)

For a detailed description of each Template, refer to “FACP Configuration Templates” on page 107. The FACP Configuration option allows the user to program the FACP with one of seven factory preprogrammed templates or one custom template which can be programmed by the user. The templates have been provided to allow the user to quickly program the panel with typical job-site configurations. The user may choose to select one of the templates or bypass this option, proceeding to the next sections which detail customized programming of the FACP.

PROGRAMMING
1=FACP CONFIG USER
2=INPUT ZONES
3=OUTPUT CIRCUITS

Programming Screen #1

A factory template may be chosen and later changed to better fit a site requirement. The changed template can be saved as the one custom template.

Pressing *1*, while viewing Programming Screen #1, will select the *FACP Config* option and display the following screen:

```

FACP CONFIG
1=TEMPLATE 1
2=TEMPLATE 2
3=TEMPLATE 3
  
```

FACP Config Screen #1

Pressing the down arrow key will display screens for additional Templates 1 through 7 and the Custom Template. During initialization of the panel following power-up or reset, the selected Template will be displayed by the LCD.

To select a pre-programmed template, press the number key corresponding to the desired template. Note that the factory templates may pre-set most programmable features of the FACP.

3.5.2 Input Zones

The Input Zones option allows the user to initially program or change the programming for the six input zones (circuits). Pressing *2*, while viewing Programming Screen #1, will select the Input Zones option and display a screen similar to the following:

```

INPUT ZONES
1=ZONE 1
2=ZONE 2
3=ZONE 3
  
```

Input Zone Screen #1

Pressing the down arrow key will display additional screens for Input Zones 4 through 6. To program a specific zone, press the number key corresponding to the desired zone while viewing one of the Input Zone screens.

To program Input Zone 1, press the *1* key while viewing Input Zone Screen #1. The following screens will be displayed:

```

INPUT ZONE 1
NORMAL PULL STATION

PRESS ↓ TO EDIT
  
```

Edit Input Zone Screen #1

To change the programming for the displayed zone, press the keyboard 'down' arrow key to view the Edit Zone screens.

The following examples show the editing of Input Zone 1:



Edit Input Zone Screen #2

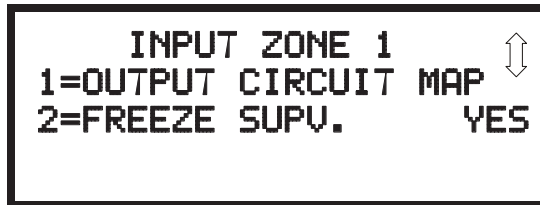

Edit Input Zone Screen #3



Edit Input Zone Screen #3

Enable/Disable Zone

To Enable or Disable the zone, press the 1 key while viewing the Edit Input Zone Screen #2. Each press of the key will toggle the screen between *Enabled Yes* and *Enabled No*. If *Enabled No* is selected, the zone will be disabled by the control panel, preventing the circuit from reporting alarms and troubles to the panel. The control panel LCD will display the zone which has been disabled and FACP will turn on the Trouble indicator.

Type

To select the type of zone being programmed, press the 2 key while viewing the Edit Input Zone Screen #2. This will cause the control panel to display the following Zone Type Screen:

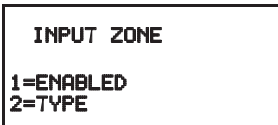

Edit Input Zone Screen #2



Zone Type Screen #1

Pressing the down arrow key displays additional zone types as indicated in the following table.

Zone Type	Action When Activated
Pull-Station	Fire Alarm
Manual Release ¹	Fire Alarm
N/A	
Normally Open Contact	Fire
N/A	
N/A	
N/A	
Waterflow	Fire
Waterflow NS (nonsilenceable)	Fire, nonsilenceable
Combo	Fire/Supervisory
Combo w/AutoResettable Superv ²	Fire/Supervisory, nonlatching
2-Wire Smoke	Fire Alarm
2-Wire Heat	Fire Alarm
N/A	
Linear Heat	Fire Alarm
N/A	
N/A	
Fire	Fire Alarm
Low Pressure	Supervisory, latching
Low Pressure AutoResettable ²	Supervisory, nonlatching
High Pressure	Supervisory
High Pressure AutoResettable ²	Supervisory, nonlatching
Disable Release ³	Supervisory, nonlatching (disables Release Circuits)
Supervisory	Supervisory, latching
Supervisory AutoResettable ²	Supervisory, nonlatching
N/A	
2nd-Shot Water Switch ⁴	Fire Alarm, nonlatching

Table 3.1 Zone Types

- 1 Activation of a Manual Release Switch will override Predischarge Delay, resulting in an immediate water release.
- 2 *AutoResettable* means that a device with this type code, when activated, will automatically reset when the corresponding condition is cleared.
- 3 *Disable Release* allows the installer to disable the releasing solenoids during system testing. *Disable Release* will only work when the system is **not** in alarm.
- 4 The *2nd-Shot Water Switch* provides the option of performing another immediate water release manually. Refer to "2nd-Shot Water Switch" on page 89.

While viewing any Zone Type screen, select the type of zone being programmed by pressing the corresponding keyboard number key. The display will return to Edit Input Zone Screen #2 and indicate the selection next to the Type option.

Output Circuit Map

Output Mapping (per input zone) allows the programmer/operator to assign the Output Circuits that will be activated when a particular Input Zone or cross-zoned releasing group goes active. Pressing 1 for *Output Circuit Map* while viewing Edit Input Zone Screen #3 will display screens which show the Output Circuits programmed to activate when the selected Input Zone (or cross-zoned releasing group) is activated. Output Map Screen #1 displays the Output Type Codes and programming for Output Circuits 1 through 3 and Output Map Screen #2 displays the Output Type Code and programming for Output Circuit 4.

INPUT ZONE #
1=OUTPUT CIRCUIT MAP
2=FREEZE SUPV.

Edit Input Zone Screen #3

As an example, if Template 1 has been selected as the FACP Configuration [refer to “FACP CONFIG (Application Templates)” on page 49], selecting the Output Circuit Map for Input Zone 1 will display the following screens:

```

OUTPUT MAP ZONE 1 ↓
1=ALARM NAC YES
2=WATERFLOW NAC NO
3=RELEASE 1 YES
  
```

Output Map Screen#1

```

OUTPUT MAP ZONE 1 ↑
4=SUPV BELL NAC N/A
  
```

Output Zone Screen#2

The screens indicate that when Input Zone 1 is activated:

- Output Circuit #1 default programmed as *Alarm NAC* will activate (Yes)
- Output Circuit #2 default programmed as *Waterflow NAC* will not activate (No)
- Output Circuit #3 default programmed as *Release 1* will activate (Yes)
- Output Circuit #4 default programmed as *Supv Bell NAC* is not mapped (N/A)

Note that the MAP may indicate that an Input Zone is programmed to a particular Output Circuit but, if it is cross-zoned with one or more other Input Zones, all must be active in order to activate the Output Circuit. Refer to the examples in “Circuit Mapping and Cross-Zoning” on page 102.

The Output Circuit Map can be customized by selecting or deselecting any of the four output circuits for activation. Pressing the number key corresponding to the selected output will toggle the display between *Yes* for activation by the Input Zone to *No* for no activation. The new customized programming is automatically saved by the panel as soon as it is entered.

Freeze Supervision

Pressing 2 for Freeze Supervision while viewing Edit Input Zone Screen #3, will program the FACP to supervise the devices connected to the selected zone for a temperature freeze condition. Each press of the 2 key will toggle the display between *Freeze Supv. Yes* and *No*. The factory default setting is No Freeze Supervision.

```

INPUT ZONE #
1=NOUN/ADJECTIVE
2=DESCRIPTION
*****

```

Noun/Adjective

The Noun/Adjective selection allows the programmer to enter specific descriptors about the detector currently being programmed. Pressing *1* while viewing Edit Input Zone Screen #3 will cause the following screen to be displayed:

Edit Input Zone Screen

```

1=STANDARD ADJECTIVE
2=STANDARD NOUN

```

Noun/Adjective Screen

Pressing *1* while viewing the Noun/Adjective Screen will cause the following screen(s) to be displayed. Note that the keyboard *down* arrow key must be pressed to see all the Adjective screens. Press the number corresponding to the adjective that is to be used as a descriptor for the location of the detector currently being programmed. When an adjective has been selected, it will appear at the top of the display as indicated by the asterisks.

```

*****
1=NORTH
2=SOUTH
3=EAST

```

Adjective Screen #1

```

*****
1=WEST
2=FRONT
3=CENTER

```

Adjective Screen #2

```

*****
1=REAR
2=UPPER
3=LOWER

```

Adjective Screen #3

```

*****
1=MAIN
2=FIRST
3=2ND

```

Adjective Screen #4

```

*****
1=3RD
2=4TH
3=5TH

```

Adjective Screen #5

```

*****
1=FLOOR1
2=FLOOR2
3=FLOOR3

```

Adjective Screen #6

```

*****
1=FLOOR4
2=FLOOR5
3=ROOM

```

Adjective Screen #7

Pressing 2 while viewing the Noun/Adjective Screen will cause the following screen(s) to be displayed. Note that the keyboard *down* arrow key must be pressed to see all the Noun screens. Press the number corresponding to the noun that is to be used as a descriptor for the location of the detector currently being programmed. When a noun has been selected, it will appear at the top of the display as indicated by the asterisks.

```
*****
1=BASEMENT
2=BOILER RM
3=CLASSROOM
```

Noun Screen #1

```
*****
1=COMPUTER RM
2=CONTROL RM
3=DATA ROOM
```

Noun Screen #2

```
*****
1=DOCUMENT RM
2=ELECTRIC RM
3=GARAGE
```

Noun Screen #3

```
*****
1=HVAC RM
2=ISLAND
3=KITCHEN
```

Noun Screen #4

```
*****
1=ROOM
2=STOREROOM
3=TELCO ROOM
```

Noun Screen #5

```
*****
1=UPS ROOM
2=VAULT
```

Noun Screen #6

Description

```
INPUT ZONE #
1=NOUN/ADJECTIVE
2=DESCRIPTION
Edit Input Zone Screen #3
```

The Description selection allows the programmer to enter additional information about the detector currently being programmed. This information will be displayed as part of the device label on the display. Pressing 2 while viewing Edit Input Zone Screen #3 will cause the following screen to be displayed:

```
ZONE # DESCRIPTION
PRESS ENTER IF DONE
*****
```

Adjective/Noun Screen

A flashing cursor will appear at the first asterisk to the left. The programmer can enter additional descriptive information about the device being programmed. This information will appear on the display along with the standard device label information.

A maximum of 20 characters (including spaces) can be entered. To enter alphanumeric characters from the keypad, repeatedly press the appropriate key until the desired character is displayed in the first position. For example, to enter the letter *B*, press the 2 (ABC) key three times to toggle through the characters *I*, *A*, and *B*. Press the right arrow key to move the cursor one position to the right and repeat the process to enter the next character. To enter a space, press the * (QZ) key four times until a blank appears in the desired position. When all characters have been entered, press the Enter key to store the information. The display will return to the Edit Detector Screen #5, displaying the new information at the bottom of the screen.

Recall/Increment Function

In addition, the user may use the Recall/Increment function at any time when the cursor is on the first letter of the Description, Adjective or Noun field as follows:

- If the zero key is pressed, a 0 is placed in the first letter position.
- If the zero key is then pressed a second time with no intervening key actions, the entire field is replaced with the field entered *for the previous device programmed*, and the cursor moves to the last character of the field (Recall function). The Recalled Adjective or Noun field may now be changed letter-by-letter.
- If the zero key is pressed again with no other intervening key actions and the last character in the field is a number 0-9, the number is incremented by one. If the last character is a letter, it changes to a 0. If the last character goes from 9 to 0 and the characters to the left of the last character are also numbers, they are also incremented (overflow).
- The above increment function may be repeated with each press of the zero key.

As an example, the user could quickly enter 'FLR_3_ROOM_305' as follows:

1. The cursor is on the first letter of the Adjective field. Press the zero key twice to display *FLR_3*.
2. With the cursor on the first letter of the Noun field, press the zero key twice to recall the display *ROOM_304*. The cursor automatically jumps from the first to the last letter of the Noun field.
3. With the cursor on the last letter of the Noun field, press the zero key again to increment the room number to *305*.
4. Press the Enter key to store the information.

3.5.3 Output Circuits

The options for the Output Circuits on the control panel main circuit board can be configured by pressing 2 while viewing Programming Screen #2. The following screens will be displayed:

PROGRAMMING
1=FACP CONFIG
2=INPUT ZONES
3=OUTPUT CIRCUITS

Programming Screen #1

OUTPUT CIRCUITS ↓
1=OUTPUT 1
2=OUTPUT 2
3=OUTPUT 3

NAC Selection Screen

OUTPUT CIRCUITS ↑
1=OUTPUT 4

NAC Selection Screen

The Output Circuits can be configured independently by pressing 1 for Output 1, 2 for Output 2, 3 for Output 3 or 4 for Output 4.

To program an Output circuit, press the number corresponding to the Output to be programmed. The following screens will be displayed for each selection:



Output Screen #1

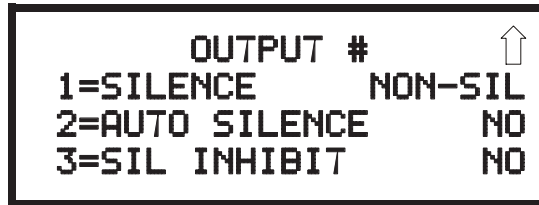

Output Screen #2

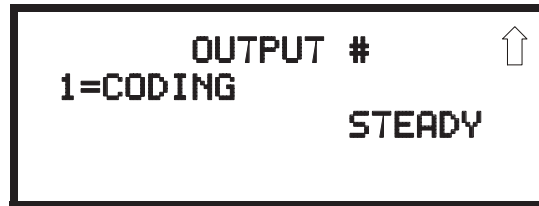

Output Screen #3

Enabled

Pressing 1 while viewing Output Screen #1 will cause the display to change to *Enabled No*. This will prevent the selected main circuit board NAC from activating its devices. Each press of the 1 key will cause the display to toggle between *Enabled Yes* and *Enabled No*.

Note that if a circuit is disabled, a *trouble* will be logged on the FACP until the circuit is enabled. The exception is when a Release Circuit is disabled, a *supervisory* will be logged on the FACP until the circuit is enabled.

Type

Pressing 2 while viewing Output Screen #1 will cause the following screen to be displayed:

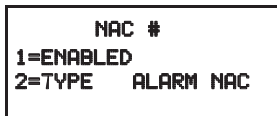

NAC Screen #1

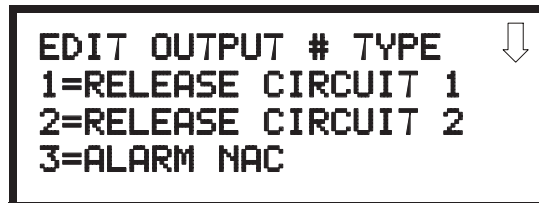

Edit Output # Type Screen

Pressing the down arrow key while viewing the Edit Output Type Screen will display additional screens with the types shown below:

- ✓ Release Circuit 1
- ✓ Release Circuit 2
- ✓ Alarm NAC
- ✓ Waterflow NAC
- ✓ Release Stage NAC
- ✓ Horn NAC
- ✓ Strobe NAC
- ✓ Supv Bell NAC
- ✓ Trouble Bell NAC

Press the number key corresponding to the desired Output Type to program the selected Output.

■ Release Circuit 1 or Release Circuit 2

If Release Circuit 1 or Release Circuit 2 is selected as the Output Type, the following subscreen will be displayed:

```
EDIT RELEASE CIR #
1=UNSUPV SHORTS
2=SUPV SHORTS
```

This screen allows the programmer to select whether or not to supervise the Releasing Circuit Output for shorts.

- UNSUPV SHORTS - this option should normally be selected when a releasing solenoid is connected to the output so the solenoid coil is not supervised for shorts
- SUPV SHORTS - this option, which supervises for shorts, should only be selected when the REL-4.7K option is installed in series with the solenoid coil



NOTE: Release circuits may be directly activated by a single input zone or may be activated using cross-zoned inputs. Refer to “Circuit Mapping and Cross-Zoning” on page 102 for a description of cross-zoning and input to output circuit mapping.

■ Release Stage NAC

If Release Stage NAC is selected as the Output Type, the following subscreen will be displayed:

```
RELEASE STAGES
1=RELEASE 1 ONLY
2=RELEASE 2 ONLY
```

An NAC can be used to signal the stages of a release operation. This screen allows the programmer to select the NAC output that will indicate the release stages for Release Circuit 1 or Release Circuit 2. For a description of this feature, refer to “Release Stages” on page 90.

Silence

Pressing *1* while viewing Output Screen #2 will cause the following screen to be displayed:

```

OUTPUT #
1=SILENCE NON-SIL
2=AUTO SILENCE NO
3=SIL INHIBITED NO
Output Screen #2

```

```

SILENCEABLE
1=SILENCEABLE
2=NON SILENCEABLE
3=SYNC MUTE

```

Silenceable Screen

Pressing *1* while viewing the Silenceable Screen will program the selected Output as a silenceable circuit. This will allow the Output to be silenced by pressing the Alarm Silence key or by the Auto Silence feature.

Pressing *2* while viewing the Silenceable Screen will program the selected Output as a nonsilenceable circuit. This will prevent the selected main circuit board Output from being silenced by pressing the Alarm Silence key or by the Auto Silence feature.

Pressing *3* while viewing the Silenceable Screen will program the selected Output as a *SYNC MUTE* (synchronized mute) circuit. Refer to “Synchronized NAC Operation” on page 61 for a description of synchronization.

Important: *When an Output Circuit with a mix of audible and visual devices is programmed for Sync Mute, only the audible devices will be turned off if the Silence key is pressed or if the Autosilence feature is enabled. The visual devices (strobes, etc.) will continue to operate.*



NOTE: If the Output Circuit has been programmed as a Releasing Circuit, the Silenceable Option will not be available and the display will indicate *N/A* next to it.

Auto Silence

The Auto Silence feature, when enabled, automatically silences all main circuit board silenceable notification appliances after a programmed length of time. To enable this feature and program the time delay before Auto Silence activation, press 2 while viewing Output Screen #2. The following screens will be displayed:



Auto Silence Screen #1

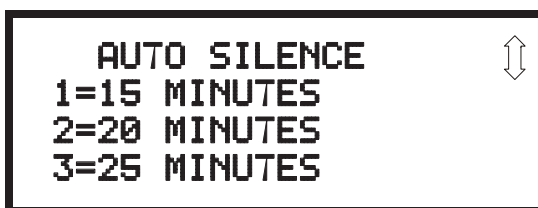

Auto Silence Screen #2



Auto Silence Screen #3

To disable the Auto Silence feature, press 1 for *No* while viewing Auto Silence Screen #1. To enable the Auto Silence feature, press the number corresponding to the time delay which will elapse before Auto Silence activates. This information will be stored in memory and the display will return to NAC Screen #1.



NOTE: If the Output Circuit has been programmed as a Releasing Circuit, the Auto Silence Option will not be available and the display will indicate *N/A* next to it.

OUTPUT #	
1=SILENCEABLE	YES
2=AUTO SILENCE	NO
3=SIL INHIBITED	NO

Output Screen #2

Silence Inhibited

The Silence Inhibit feature, when enabled, prevents the silencing of the selected main circuit board Output for a period of one minute. Resetting the FACP will also be prevented for one minute while the Output programmed for silence inhibit is activated. Pressing 3 while viewing Output Screen #2

will cause a screen to be displayed with the options *1=No Silence Inhibit* and *2=1 Min. Silence Inhibit*. Pressing *1* will disable the Silence Inhibit feature while pressing *2* will enable a 1 minute Silence Inhibit for the selected Output.

Coding

The Coding feature allows the programmer to select the type of output that the main circuit board outputs will generate when activated. Pressing *1* while viewing Output Screen #3 will cause the following displays to appear:

```

OUTPUT
#1=CODING
  
```

Output Screen #3

```

CODING
1=STEADY
2=MARCH TIME
3=CALIFORNIA
  
```

Coding Screen #1

```

CODING
1=TEMPORAL
2=FUTURE USE
3=FUTURE USE
  
```

Coding Screen #2

```

CODING
1=CROSS ZONE
2=SYNC SYSTEM SENSOR
3=SYNC WHEELLOCK
  
```

Coding Screen #3

```

CODING
1=SYNC GENTEX
2=SYNC FARADAY
3=SYNC AMSECO
  
```

Coding Screen #4

The programmer can select the notification appliance output coding by pressing the number corresponding to the desired output. The coding selections are:

- Steady - a continuous output with no coding
- March Time - 120 ppm (pulse-per-minute) output
- California - 10 seconds on and 5 seconds off
- Temporal - ½ second on, ½ second off, ½ second on, ½ second off, ½ second on, 1½ second off
- Cross-Zone:
 - ✓ 1st zone of a cross-zoned group in alarm causes programmed NAC output to pulse 1 second on and 1 second off
 - ✓ 2nd zone of a cross-zoned group in alarm causes programmed NAC output to pulse ½ second on and ½ second off - *Note: if more than three zones are cross-zoned, the programmed NAC output will continue to pulse ½ second on and ½ second off for each subsequent zone in alarm, until the final zone in the cross-zoned group goes into alarm*
 - ✓ All zones of a cross-zoned group in alarm causes the output programmed as a Releasing Circuit to perform a release and the programmed NAC output to turn on steady
- Synchronized output for System Sensor, Wheelock, Gentex, Faraday or Amseco - Refer to “Synchronized NAC Operation” on page 61 for additional information.

Selection of one of the above options will cause the control panel to store the information in memory and return the display to Output Screen #1, which will display the new coding choice.



NOTE: If the Output Circuit has been programmed as a Releasing Circuit, the Coding Option will not be available and the display will indicate *N/A* next to it.

■ Synchronized NAC Operation

Synchronization is a panel feature that controls the activation of notification appliances in such a way that all horns and strobes will turn on and off at exactly the same time. This is particularly critical when activating strobes which must be synchronized to avoid random activation and a potential hazard or confusion. The FACP can be programmed to operate with a variety of manufacturer’s devices.



NOTES:

1. The NAC1 output can be used to synchronize notification appliances connected to external panels such as remote power supplies (wire NAC1 to the power supply sync input)
 2. For Dual Hazard applications, NAC circuits are not synchronized across dual hazard areas
-

Maximum Number of Strobes for Synchronization

The maximum current draw for a Notification Appliance Circuit cannot exceed 3.0 amps. Refer to the manufacturer’s documentation supplied with the Strobes to determine the maximum current draw for each strobe and ensure that the circuit maximum is not exceeded.

To ensure proper strobe and circuit operation, there is also a limit to the number of strobes that can be attached to each circuit. Following is a list of the strobes that have been tested with this FACP and the maximum number that can be connected to each NAC. Make sure that the NAC maximum current is not exceeded:

- ✓ System Sensor: 46 Strobes
- ✓ Wheelock: 50 Strobes
- ✓ Gentex: 39 Strobes
- ✓ Faraday: 33 Strobes
- ✓ Amseco: 34 Strobes

Refer to the Device Compatibility Document for a list of compatible devices.

3.5.4 Cross Input Zones

PROGRAMMING
1=CROSS INPUT ZONES
2=ON-BOARD RELAYS
3=SYSTEM SETUP

Programming Screen

An application may require that two or more input zones become active at the same time before a particular releasing output activates. This is referred to as cross-zoning. For example, an installer may want four particular zones to become active at the same time before a releasing circuit is activated. By using the Cross Input Zone feature, the programmer can designate the input zones that must become active and the output circuits that will be affected. Refer to “Circuit Mapping and Cross-Zoning” on page 102 for additional information.

The Cross Input Zone option allows the user to view and program the groups of input zones that will be used to activate one of the releasing output circuits. Pressing 1 while viewing Programming Screen #2 will display a screen similar to the following:

```

CROSS INPUT ZONES
1=RELEASE 1 GROUPS
2=RELEASE 2 GROUPS
    
```

This screen allows the programmer to view the cross-zoned grouping for Release Circuit 1 or Release Circuit 2. In the following example, Template 7 has been chosen as the FACP Configuration [refer to “FACP CONFIG (Application Templates)” on page 49]. Pressing 1 for Release 1 Groups will display the following screen:

```

REL 1 CROSS GROUPS
1=                X 1 2
2=                NONE
3=                NONE
    
```

The display indicates that Input Zone 1 is cross-zoned with Input Zone 2. Input Zone 3 is not cross-zoned.

The user can alter the cross-zoning by pressing the number key corresponding to the Zone to be reprogrammed. Screens similar to the following will be displayed:

```

REL 1 CROSS GROUP 1 ↓
1=ZONE 1           YES
2=ZONE 2           YES
3=ZONE 3           NO
    
```

Select Cross Zone Screen #1

```

REL 1 CROSS GROUP 1 ↑
1=ZONE 4           NO
2=ZONE 5           NO
3=ZONE 6           N/A
    
```

Select Cross Zone Screen #2

In this example, since the cross-zoning for Release Circuit 1 (Zone 1) is being displayed, *Yes* is shown for Zone 1 which is cross-zoned with Zone 2. Zone 2 displays *Yes* since it is cross-zoned with Zone 1. The remaining zones display *NO* or *N/A* for no cross-zoning to Zone 1. By pressing the number key corresponding to the desired zone, the display for that zone will toggle between *Yes* and *No* indicating cross-zoning to Zone 1 or no cross-zoning to Zone 1.

3.5.5 On-Board Relays

Pressing 2 while viewing Programming Screen #2 will allow the programmer to configure the three main circuit board Form-C relays. The following screen will be displayed:

```

ON-BOARD RELAYS
1=RELAY 1      ALARM
2=RELAY 2      TROUBLE
3=RELAY 3      SUPERVSRY
  
```

Relays Selection Screen

To program Relay 1, 2 or 3, press the number corresponding to the selected relay. The following screen will be displayed:

```

RELAY #
1=TYPE          ALARM
2=LATCHING      NO
  
```

Relay Programming Screen

Pressing 1 for Type will display the following screens:

```

RELAY TYPE      ↓
1=ALARM
2=TROUBLE
3=SUPERVISORY
  
```

Relay Screen #1

```

RELAY TYPE      ↑
1=FUTURE USE
2=DISCHARGE
3=AC LOSS
  
```

Relay Screen #2

While viewing the selected screen, press the number corresponding to the desired relay type to program the main circuit board relay. The choice will be stored in memory and the display will return to the Relay Type Screen which will show the programmed type choice. Press the Escape key to return to the Relays Selection Screen and repeat the preceding procedure for the remaining relays.

Pressing 2 for Latching will toggle the display between *Latching Yes* and *No*.

If *Latching Yes* is selected, when the Relay is activated, the condition causing the activation must be cleared and the FACP must be reset to clear the Relay.

If *Latching No* is selected, when the Relay is activated, the Relay will reset as soon as the condition causing the activation is cleared. The FACP does not need to be reset.

3.5.6 System Setup

System Setup allows the programmer to configure the following control panel features:

- *Timers*: This option allows the programmer to set the Soak 1, Soak 2, Waterflow and AC Loss time delays.
- *Banner*: This option allows the user to change the top two lines of the LCD display from the factory default readout to a user defined readout when the control panel is in Normal condition.
- *Time-Date*: This feature allows the programmer to set the time, display format (24 hr or 12 hr), date and daylight savings time feature into the FACP memory
- *Trouble Reminder*: This feature, when enabled, provides an audible reminder that an alarm or trouble still exists on the FACP after the control panel has been silenced. The control panel piezo sounder will pulse once every 15 seconds during an alarm and every two minutes during a trouble condition, after the Alarm Silence or Acknowledge key is pressed. The piezo will continue to sound at these rates until the alarm or trouble condition is cleared. If the *Trouble Reminder* feature is not enabled and a trouble condition is not cleared within 24 hours, the panel will reactivate the trouble sounder and send an Abnormal 24 hour Test message via the optional communicator.
- *Charger Disable*: This option allows the programmer to disable the onboard battery charger in the event an external battery charger is being used.
- *Canadian Option*: This option allows the automatic programming of the FACP to Canadian specifications (refer to “Canadian Option” on page 70).
Important! For Canadian Applications, this option must be set to ON prior to any other panel programming.

Pressing 3 for System Setup, while viewing Programming Screen #2, will cause the following screens to be displayed:

```

PROGRAMMING
1=CROSS INPUT ZONES
2=ON-BOARD RELAYS
3=SYSTEM SETUP
Programming Screen

```

```

SYSTEM SETUP
1=FUTURE USE
2=TIMERS
3=BANNER

```

System Setup Screen #1

```

SYSTEM SETUP
1=TIME-DATE
2=TROUBLE REMIND NO
3=CHARGR DISABLE NO

```

System Setup Screen #2

```

SYSTEM SETUP
1=CANADIAN OPTION OFF

```

System Setup Screen #3

```

SYSTEM SETUP
1=FUTURE USE
2=TIMERS
3=BANNER
System Setup Screen #1

```

Timers

Timers for Soak, Waterflow Delay and AC Loss Delay can be programmed by pressing 2 while viewing System Setup Screen #1. The following screen will be displayed:

```

TIMERS
1=SOAK 1 10 MIN
2=SOAK 2 10 MIN
3=WATERFLOW DELAY 60S

```

Timer Screen #1

```

TIMERS
1=AC LOSS DELAY 2 HR

```

Timer Screen #2

■ Soak 1 or Soak 2

The factory default setting for Soak Time is 10 minutes. To select a Soak Time delay of 10 to 30 minutes, press 1 for Soak 1 (Release Circuit 1) or 2 for Soak 2 (Release Circuit 2) while viewing Timer Screen #1. The following display will appear:



Soak Time Setup Screen

Pressing 1 while viewing the Soak Time Setup Screen will program the corresponding releasing circuit to remain on during alarm activation until the alarm is cleared and the panel is reset.

Pressing 2 while viewing the Soak Time Setup Screen will display the following screen:



Soak Time Screen

This screen allows the user to program a specific length of time for the releasing circuit to remain active after an input initiating a release has cleared. A flashing cursor is positioned in the lower left corner of the display. Enter a soak time consisting of two digits, such as 10 for ten minutes. Upon entering the second digit, the time delay will be stored in the control panel memory and the display will return to the Delay Screen which will indicate the new soak time. In this example, when the input circuit which initiated a release has cleared, the soak timer will start, allowing the releasing circuit to continue releasing water for a total of ten minutes and then deactivate.



Timer Screen #1

■ Waterflow Delay

A delay can be added prior to declaring a waterflow type of alarm. Be careful to include any built-in delays of the waterflow device. The factory default setting for Waterflow delay is 00 for no delay. To select a Waterflow delay of 01 to 90 seconds for all devices programmed for Waterflow delay, press 3 while viewing Timer Screen #1 to display the following screen:

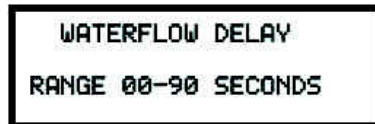

Waterflow Delay Screen

A flashing cursor is positioned in the lower left corner of the display. Enter a delay time consisting of two digits, such as 25 for twenty-five seconds. Upon entering the second digit, the time delay will be stored in the control panel memory and the display will return to the Delay Screen which will indicate the new delay time.

■ AC Loss Delay

The reporting of a loss of AC power can be delayed by programming the length of the desired delay. Press *1* while viewing Timer Screen #2 to display the following:

```

AC LOSS DELAY
RANGE 00-24 HOURS
  
```

AC Loss Delay Screen #1

```

TIMER
1=AC LOSS DELAY 2 HR
  
```

Timer Screen #2

A flashing cursor will appear in the lower left corner of the display. The factory default setting is 02 hours. Type the two digit AC loss reporting delay in hours (00 to 24 hour delay). When the second digit is entered, the display will return to AC Loss Delay Screen #1.



NOTE: Upon the loss of AC power at the control panel, relays programmed for AC Loss will transfer immediately, regardless of the AC Loss Delay setting. If no troubles other than AC Loss exist in the panel, the System Trouble relay will delay activation for the duration of the AC Loss Delay setting.

Banner

The top line of the display, which appears when the control panel is in normal mode, can be changed by using the Banner option. Pressing *2* while viewing System Setup Screen #1 will cause the following to be displayed:

```

SYSTEM SETUP
1=UTURE USE
2=TIMERS
3=BANNER
  
```

System Setup Screen #1

```

SELECT BANNER
1=FACTORY BANNER
2=USER BANNER
  
```

Select Banner Screen

Pressing *1* while viewing the Select Banner Screen will display the following screen:

```

FACTORY BANNER

PRESS ENTER IF OK
  
```

User Defined Banner Screen #1

This screen allows the user to select the factory default Banner which will be displayed when the system is in Normal Mode of operation. Press the *Enter* key to accept this as the default display. Press the *Escape* key to cancel and return to the Select Banner Screen.

Pressing 2 while viewing the Select Banner Screen will display the following screen:



User Defined Banner Screen

This screen allows the programmer to enter a custom banner. A flashing cursor will appear in the bottom left corner of the display. A maximum of 20 characters (including spaces) can be entered into the screen. After entering up to 20 characters in the screen, press *Enter* to store the entry. To quickly clear the current banner, press the *CLR* key.

To enter alphanumeric characters from the keypad, repeatedly press the appropriate key until the desired character is displayed in the first position. For example, to enter the letter *B*, press the 2 (*ABC*) key three times to toggle through the characters *A*, *B*, and *C*. Press the right arrow key to move the cursor one position to the right and repeat the process to enter the next character. To enter a space, press the * (*QZ*) key four times to place a blank in the desired position. When all characters have been entered, press the *Enter* key to store the information. The display will return to the Select Banner Screen.

Time-Date

The control panel time and date can be changed by pressing 1 while viewing the System Setup Screen #2. The following screen will be displayed:

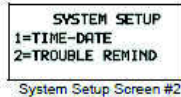

System Setup Screen #2

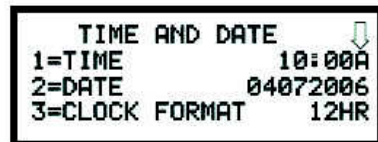

Time-Date Screen #1



Time-Date Screen #2

■ **Time**

To change the time, press 1 while viewing the Time-Date Screen. The following screen will be displayed:



Time Screen

A flashing cursor is located toward the top left of the display. Below the cursor is the current time. To change the time, enter the two-digit hours followed by the two-digit minutes. The cursor will move one position to the right each time a digit is entered. After the last minutes digit is entered, the cursor will again move one position to the right. At this point enter 1 for AM or 2 for PM. The display will then return to the Time-Date Screen which will show the new time entry. If an error is made while entering a digit, press the CLR key to delete the entire entry and beginning again.

■ Date

To change the date, press 2 while viewing the Time-Date Screen. The following screen will be displayed:

```

ENTER DATE
**--**--****
MONTH DAY YEAR
04-07-2006
  
```

Date Screen

A flashing cursor is located toward the top left of the display. Below the cursor is the current date. To change the date, enter the two-digit month followed by the two-digit day and then the two-digit year (01 for 2001, 02 for 2002, etc.). The cursor will move one position to the right each time a digit is entered. After the last year digit is entered, the display will return to the Time-Date Screen which will show the new date entry. If an error is made while entering a digit, press the CLR key to delete the entire entry and beginning again.

■ Clock Format

The clock can be configured to display 12 hour (AM & PM) or 24 hour (military) time. Pressing 3 while viewing the Time-Date screen will cause the display to toggle between 12HR and 24HR. Select 12HR for 12 hour display or 24HR for 24 hour display.



NOTE: If the clock is changed to 24 hour (military) format, the date will change to the European standard of Day-Month-Year (for display purposes only).

Daylight Savings Time

Pressing 1 while viewing Time-Date Screen #2 will cause the following screens to be displayed:

```

TIME AND DATE
1=DAYLIGHT SAVINGS
  
```

Time & Date Screen #2

```

DAYLIGHT SAVINGS
1=ENABLED      YES
2=START MONTH  MAR
3=START WEEK   WK 2
  
```

Daylight Savings Screen #1

```

DAYLIGHT SAVINGS
1=END MONTH    NOV
2=END WEEK     WK 1
  
```

Daylight Savings Screen #2

Pressing *1* while viewing Daylight Savings Screen #1 will cause the display to toggle between *Enabled Yes* and *Enabled No*. The control panel will automatically update the time for daylight savings time when *Enabled Yes* is selected.

Pressing *2* while viewing Daylight Savings Screen #1 will display another screen which allows the programmer to select the month that daylight savings time will begin. In this sub-screen, pressing *1* will select March, *2* will select April, and *3* will select May.

Pressing *3* while viewing Daylight Savings Screen #1 will display two sub-screens which allow the programmer to select the week of the month that daylight savings time will begin. In the first sub-screen, pressing *1* will select the first week, *2* will select the second week, and *3* will select the third week, while in the second sub-screen, pressing *1* will select the fourth week and *2* will select the last week of the selected month.

Pressing *1* while viewing Daylight Savings Screen #2 will display another screen which allows the programmer to select the month that daylight savings time will end. In this sub-screen, pressing *1* will select September, *2* will select October, and *3* will select November.

Pressing *2* while viewing Daylight Savings Screen #2 will display two sub-screens which allow the programmer to select the week of the month that daylight savings time will end. In the first sub-screen, pressing *1* will select the first week, *2* will select the second week, and *3* will select the third week, while in the second sub-screen, pressing *4* will select the fourth week and *5* will select the last week of the selected month.

<p>SYSTEM SETUP 1=TIME-DATE 2=TROUBLE REMIND 3=CHARGR DISABLE</p>
--

System Setup Screen #2

Trouble Reminder

The Trouble Reminder feature causes the control panel piezo to sound a reminder ‘beep’ for alarms and troubles, after the panel has been silenced. Refer to “System Setup” on page 64, for a detailed description of this feature. Pressing *2* while viewing System Setup Screen #2 will cause the display to toggle to *Trouble Remind Yes*, which enables this feature. Each press of the *2* key will cause the display to toggle between *Trouble Remind Yes* and *Trouble Remind No*.

Note that if the Trouble Reminder feature is not enabled, a trouble existing on the panel for more than 24 hours will cause the FACP to resound the trouble sounder.

Charger Disable

Pressing *3* while viewing System Setup Screen #2 will allow the programmer to enable or disable the onboard battery charger. If an external battery charger is being used, the onboard battery charger must be disabled. Each press of the *3* key will toggle between *Chargr Disable No* and *Chargr Disable Yes*.

Canadian Option

Pressing *1* while viewing System Setup Screen #3 will configure the FACP to comply with Canadian requirements. The display will change to *Canadian Opt. On*. Each press of the *2* key will cause the display to toggle between *Canadian Opt. On* and *Canadian Opt. Off*. The factory default setting is *Canadian Opt. Off*.

The Canadian Options configures the FACP with the following as required by Canada:

- The following zone type codes are not available:
 - ✓ non-latching supervisory
 - ✓ non-latching drill
- Any allowed zone type programmed as Auto-Resettable will be changed to latching version of that zone type (N.O. Contact AR will be changed to N.O. Contact, Combo with AR Supervisory will be changed to Combo, 2-wire Heat AR will be changed to 2-wire Heat, Low Pressure AR will be changed to Low Pressure, High Pressure AR will change to High Pressure and Supervisory AR will change to Supervisory)
- The auto-silence feature can be enabled or disabled. If this feature is enabled, the alarm signals will be turned off after 20 minutes of activation

- The installer must write in the Date of Final Assembly on the Master Marking and Warranty label, located on the FACP backbox door

3.5.7 ANN-BUS

PROGRAMMING
1=ANN-BUS
2=HISTORY
3=WALKTEST
Programming Screen #3

Optional ANN-BUS devices available for the FACP include annunciators, relay modules and printer connection for acquiring hardcopy printouts of panel data. Pressing 1 while viewing Programming Screen #3 will cause the control panel to display the following screens.

```

ANN-BUS
1=BUS ENABLED      NO
2=BUS MODULES
3=AUTO CONFIGURE
  
```

ANN-BUS Screen #1

```

ANN-BUS
1=ANN-S/PG OPTIONS
2=ANN-80 OPTIONS
3=ANN-RLY OPTIONS
  
```

ANN-BUS Screen #2

An N-ANN-S/PG Printer module, N-ANN-80 LCD annunciator module and N-ANN-RLY relay module can be programmed in the FACP. These devices communicate with the FACP over the ANN-BUS terminals on the control panel.

ANN-BUS Enabled

The ANN-BUS must be enabled if any modules are installed on the ANN-BUS terminals. To enable the ANN-BUS, press 1 while viewing ANN-BUS screen #1 so that the display reads *ANN-BUS Enabled Yes*. Each press of the 1 key will cause the display to toggle between *ANN-BUS Enabled Yes* and *ANN-BUS Enabled No*.

ANN-BUS Modules

If an ANN-BUS module is installed, press 2 while viewing ANN-BUS screen #1 to select ANN-BUS addresses for the module(s). The following screen will be displayed.

```

ANN-BUS MODULES
1=ADDR. 1    NONE
2=ADDR. 2    NONE
3=ADDR. 3    NONE
  
```

On Board DACT Screen #1

Pressing the down arrow key will allow the programmer to view additional screens displaying Addresses 1 - 8. Pressing the number corresponding to the desired address will display a screen with technical information about the selected module.

In the technical information screen, pressing *1* for *Type* will display the following screens:

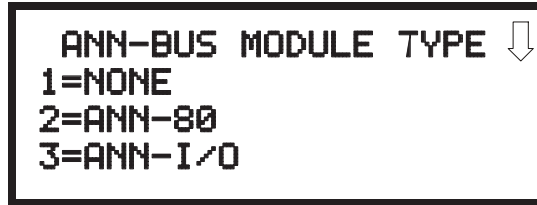

ANN-BUS MODULE TYPE ↓
1=NONE
2=ANN-80
3=ANN-I/O

Module Type Screen #1

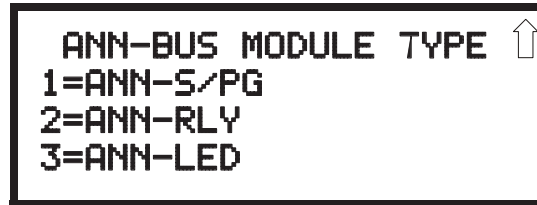

ANN-BUS MODULE TYPE ↑
1=ANN-S/PG
2=ANN-RLY
3=ANN-LED

Module Type Screen #2

Press the number corresponding to the module type, if any, that is installed with the selected address. *This will enable the module.*

Auto-Configure

The ANN-BUS Auto-Configure features allows the programmer to quickly bring all installed ANN-BUS modules online. The software will search for all ANN-BUS modules and automatically program the device type and address into the system. Pressing *3* while viewing ANN-BUS Screen #1 will begin the Auto-Configure process and cause the following screen to be displayed:



ANN-BUS
AUTO-CONGFIGURE
N PROGRESS
PLEASE WAIT

Auto-Configure Screen

PROGRAMMING
1=ANN-S/PG OPTIONS
2=ANN-I/O OPTIONS
3=ANN-80 OPTIONS

ANN-BUS Screen #2

ANN-S/PG Options

The Printer Option allows the user to configure the optional printer. Pressing *1* while viewing the ANN-BUS Screen #2 will display the following screens:

```

ANN-S/PG OPTIONS
1=PORT          PARALLEL
2=PRINTER SUPV NO
3=OFFLINE TIMER 60
  
```

Printer Options Screen #1

```

ANN-S/PG OPTIONS
1=BAUD RATE    N/A
2=DATA BITS    N/A
3=PARITY       N/A
  
```

Printer Options Screen #2

```

ANN-S/PG OPTIONS
1=STOP BITS    N/A
  
```

Printer Options Screen #3

Pressing *1* for Port while viewing Printer Options screen #1 will allow the programmer to select between a Parallel and Serial Port for printer connection. Each press of the *1* key will cause the display to toggle between *Port PAR* (parallel) and *Port SER* (serial). It is important to note that the interface selected determines which options are available to the user.

If the Parallel Port option is selected, the user has the option to supervise the printer and select an offline timer for the supervision by pressing *2* for Printer Supervision while viewing Print Options screen #1. Each press of the *2* key will cause the display to toggle between *Printer Supv NO* for no supervision and *Printer Supv YES* for printer supervision. Note that this option is not selectable if the Serial Port option has been selected.

If the Parallel Port option is selected, the user has the ability to select an *Offline Timer* by pressing *3* while viewing Print Options screen #1. The resultant screen allows the programmer to program the *Offline Timer* for a delay of between 0 and 255 seconds before loss of printer supervision is reported as a trouble.

If the Serial Port option is selected, the *Printer Supv* and *Offline Timer* options will not be available. The Baud Rate, Data Bits, Parity and Stop Bits options are only available when the Serial Port option has been selected.

Pressing *1* for *Baud Rate* while viewing Printer Options screen #2 will cause a screen to appear which allow the user to select a Baud Rate of *19200, 9600 or 2400*.

Pressing *2* for *Data Bits* while viewing Printer Options screen #2 will cause screens to appear which allow the user to select *5, 6, 7, or 8 Data Bits*.

Pressing *3* for *Parity* while viewing Printer Options screen #2 will cause a screen to appear which allows the user to select between *No Parity, Even Parity, or Odd Parity*.

Pressing *1* for *Stop Bits* while viewing Printer Options screen #3 will cause a screen to appear which allows the user to select between *0.5, 1.0, or 2.0 Stop Bits*.

N-ANN-I/O LED Zone Assignments

The information displayed by LEDs on every N-ANN-I/O module is not programmable and will therefore be as indicated in the following table.

LED	Zone (any address)
1	AC Fault
2	General Alarm
3	General Supervisory
4	General Trouble
5	Alarm Silenced
6	Earth Fault
7	Battery Fault
8	Charger Fault
9	Disable
10	Maintenance
11	Zone 1 Alarm
12	Zone 2 Alarm
13	Zone 3 Alarm
14	Zone 4 Alarm
15	Zone 5 Alarm
16	Zone 6 Alarm
17	Not Used
18	Not Used
19	Not Used
20	Not Used
21	Zone 1 Trouble
22	Zone 2 Trouble
23	Zone 3 Trouble
24	Zone 4 Trouble
25	Zone 5 Trouble
26	Zone 6 Trouble
27	Not Used
28	Not Used
29	Not Used
30	Not Used
31	Zone 1 Supervisory
32	Zone 2 Supervisory
33	Zone 3 Supervisory
34	Zone 4 Supervisory
35	Zone 5 Supervisory
36	Zone 6 Supervisory
37	Not Used
38	Not Used
39	Not Used
40	Not Used

ANN-80 Options

Pressing 2 while ANN-BUS screen #2 will display the following screen:

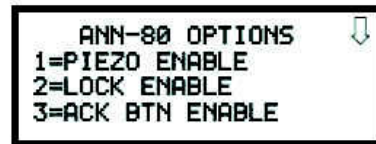

ANN-80 Options Screen #1

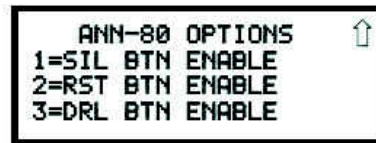

ANN-80 Options Screen #2

The *Piezo Enable* option allows the programmer to select whether the piezo sounder on any installed N-ANN-80 annunciator will ever sound. Pressing 1 while viewing the ANN-80 Options Screen #1 causes the display to toggle between *Piezo Enable Yes* and *Piezo Enable No*.

The *Lock Enable* option allows the programmer to select whether or not the N-ANN-80 LCD annunciator must be unlocked by its key before any annunciator key presses will function. Pressing 2 while viewing the ANN-80 Options Screen #1 causes the display to toggle between *Lock Enable Yes* (annunciator must be unlocked for keys to function) and *Lock Enable No* (lock position is ignored).

The Acknowledge Button Enable (*ACK BTN ENABLE*) option allows the programmer to select whether the Ack/Step button on any installed N-ANN-80 LCD annunciator will function normally or always be ignored. Pressing 3 while viewing the ANN-80 Options Screen #1 causes the display to toggle between *Ack Btn Enable Yes* (Ack/Step button functions normally) and *Ack Btn Enable No* (Ack/Step button never functions).

The Silence Button Enable (*SIL BTN ENABLE*) option allows the programmer to select whether the Silence button on any installed N-ANN-80 LCD annunciator will function normally or always be ignored. Pressing 1 while viewing the ANN-80 Options Screen #2 causes the display to toggle between *Sil Btn Enable Yes* (Silence button functions normally) and *Sil Btn Enable No* (Silence button never functions).

The Reset Button Enable (*RST BTN ENABLE*) option allows the programmer to select whether the Reset button on any installed N-ANN-80 LCD annunciator will function normally or always be ignored. Pressing 2 while viewing the ANN-80 Options Screen #2 causes the display to toggle between *Rst Btn Enable Yes* (Reset button functions normally) and *Rst Btn Enable No* (Reset button never functions).

The Drill Button Enable (*DRL BTN ENABLE*) option allows the programmer to select whether the Drill button on any installed N-ANN-80 LCD annunciator will function normally or always be ignored. Pressing 3 while viewing the ANN-80 Options Screen #2 causes the display to toggle between *Drl Btn Enable Yes* (Drill button functions normally) and *Drl Btn Enable No* (Drill button never functions).

ANN-RLY Options

Pressing 1 for *ANN-RLY Options* while viewing ANN-BUS Screen #3 will cause the following screen to be displayed:

```

PROGRAMMING
1=ANN-RLY OPTIONS
2=ANN-LED OPTIONS
  
```

ANN-BUS Screen #3

```

ANN-RLY OPTIONS
1=RELAY 1    IN ZONE 1
2=RELAY 2    IN ZONE 2
3=RELAY 3    IN ZONE 3
  
```

ANN-RLY Options Screen

The N-ANN-RLY module provides ten Form-C relays which can be programmed for various functions. The initial screen displays Relays 1 through 3. Pressing the down arrow key will display the remaining relays for this module.

To program any of the N-ANN-RLY relays, while viewing the appropriate ANN-RLY Option screen, press the number key corresponding to the relay to be programmed. Following is a list of the available programming options for each relay:

- General Alarm
- General Trouble
- General Supervisory
- Future Use
- Future Use
- Future Use
- General Discharge
- Discharge Release 1
- Discharge Release 2
- AC Loss
- Waterflow Delay
- Future Use
- Future Use
- Future Use
- General 2nd Shot Release
- 2nd Shot Release 1
- 2nd Shot Release 2
- Input Zone 1
- Input Zone 2
- Input Zone 3
- Input Zone 4
- Input Zone 5
- Input Zone 6

3.5.8 History

PROGRAMMING
 1=ANN-BUS
 2=HISTORY
 3=WALKTEST
 Programming Screen #3

The History option allows an authorized user to view or erase events which have occurred in the control panel. Pressing 2 while viewing Programming Screen #3 will display the History options as shown in the following display:

```

  HISTORY
  1=VIEW EVENTS
  2=ERASE HISTORY
  
```

History Screen

View Events

Pressing 1 while viewing the History Screen will allow the user to select the events to be viewed as illustrated in the following:

```

  HISTORY
  1=VIEW ALL
  2=VIEW ALARMS
  3=VIEW OTHER EVENTS
  
```

View Events Screen

While displaying the View Events screen, press 1 to view all events, 2 to view only alarms, or 3 to view other events. Use the up and down arrow keys to scroll through all of the displayed events.

Erase History

The Erase History option allows a user to erase all events from the history file. This will provide a clean slate in order to use the history file to track future events. Pressing 2 while viewing the History Screen will display the following screen:

```

  ERASE HISTORY
  PROCEED ?
  1=YES          2=NO
  
```

Erase History Screen

Pressing 1 while viewing the Erase History Screen will erase all events from the History file. After the History file has been erased, the display will return to the History Screen.

3.5.9 Walktest

PROGRAMMING

1=ANN-BUS
2=HISTORY
3=WALKTEST

Programming Screen #3

Walktest allows an individual to test the fire alarm system without the necessity to reset the control panel after each device activation. Pressing 3 while viewing the Programming Screen #3 will cause the following Walktest options to be displayed:

```

WALKTEST
1=SILENT
2=AUDIBLE
3=VIEW EVENTS
  
```

Walktest Screen

To perform a silent walktest which will not sound the NACs, press 1 while viewing the Walktest Screen. To perform an audible walktest, which will sound the NACs, press 2 while viewing the Walktest Screen. When either option is chosen, the panel will enter Walktest Mode and the following screen will be displayed:

```

UNIT IN WALKTEST
  
```

Walktest Active Screen

The user can now perform a one-person walktest by activating devices throughout the system. As each device is activated, the screen will display the information about the activated device as shown below. Note that the colon (:) in the time is replaced with an asterisk (*) to distinguish the walktest screen from an actual alarm screen.

```

ALARM ZONE 1
  <ADJ> <NOUN>
                Z01
10*00A 010805
  
```

After completion of the Walktest, press the *Esc* (Escape) key to exit Walktest Mode and return to the Walktest Screen. The results of the Walktest can now be viewed by pressing 3 while viewing the Walktest Screen. The following screen will be displayed:

```

WALKTEST EVENTS
  
```

Use the up and down arrow keys to view all of the walktest results which will be displayed as illustrated in the preceding screen. Note that the Walktest log is stored in RAM. If all power (AC and DC) is removed from the FACP, the Walktest log information will be lost. This information is also overwritten when subsequent walktests are performed.

3.5.10 Clear Program

Pressing *1* while viewing Programming Screen #4, will select the Clear Program option. The control panel will provide a warning to the user by prompting with the following display:

```

PROGRAMMING
1=CLEAR PROGRAM
2=PASSWORD CHANGE
  
```

Programming Screen #4

```

WARNING!
SYSTEM CHANGE
PROCEED?
1=YES          2=NO
  
```

Pressing *1* for *Yes* will cause the control panel to carry out the selected clear option. Pressing *2* for *No* will prevent programming from being cleared.

3.5.11 Password Change

The factory set passwords, which have been programmed into the control panel, can be changed by selecting the Password Change option. Pressing *2* while viewing Programming Screen #4 will cause the following screen to be displayed:

```

PASSWORD CHANGE
1=MASTER
2=MAINTENANCE
  
```

Password Change Screen

Press *1* to change the Master Programming Level password or *2* to change the Maintenance Level password. *Note that the passwords will not be displayed on annunciators.*

The following screen will appear when either change option is selected:

```

ENTER NEW FIVE DIGIT
PASSWORD
  
```

Enter Password Screen

A flashing cursor will appear in the center of the display. Enter a new five digit password (such as *10101* for the Master Level). After the fifth digit is entered, the following screen will be displayed:

```

VERIFY NEW
PASSWORD
  
```

Password Change Screen

The new five digit password must be re-entered to accept the change. The display will then return to the initial Password Change Screen.

3.6 Maintenance Programming Level

To access Maintenance Programming mode, press the *Enter* key. The LCD will display the following:



```
1=READ STATUS
2=PROGRAMMING
```

To enter the Maintenance Programming mode, press 2. The display will read as follows:



```
PROGRAMMING
ENTER PASSWORD
```

When the Maintenance level password (default *1111*) is entered, the following screen will appear:



```
PROGRAMMING
1=INPUT ZONES
2=HISTORY
3=WALKTEST
```

Note that in the preceding screens, an arrow appears to inform the programmer that additional options can be viewed by pressing the keypad *down* arrow key, as shown in the following screen.



```
PROGRAMMING
1=TIME-DATE
```

3.6.1 Input Zones - Enable/Disable

PROGRAMMING
 1=INPUT ZONES
 2=HISTORY
 3=WALKTEST
 Maintenance Screen #1

The Input Zones option allows the user to enable or disable desired zones. Pressing *1* for Input Zones, while viewing Maintenance Screen #1 will cause the following screens to be displayed:

```

POINT PROGRAM
1=ZONE 1
2=ZONE 2
3=ZONE 3
  
```

Zone Select Screen

Pressing the down arrow key will display additional Zones 4 - 6. Select the number corresponding to the desired zone. A screen will appear which will allow enabling or disabling of the selected zone, as illustrated in the following example:

```

INPUT ZONE 1
1=ENABLED YES
TYPE PULL STATION
  
```

Enable/Disable Select Screen

Pressing *1* repeatedly will cause the display to toggle between *Enabled Yes* and *Enabled No*.

3.6.2 History

Pressing *2* while viewing Maintenance Screen #1 will cause the following screen to be displayed:

```

HISTORY
1=VIEW EVENTS
2=ERASE HISTORY
  
```

History Screen

The History feature allows the operator to view control panel events which have been stored in a history file in memory and erase the contents of the history file

Pressing *1* while viewing the History screen will cause the following screen to be displayed:

```

HISTORY
1=VIEW ALL
2=VIEW ALARMS
3=VIEW OTHER EVENTS
  
```

To view all the events which have occurred in the control panel since the history file was last erased, press *1* while viewing the Events screen. To view only alarms which have occurred, press *2* while viewing the Events screen. To view events other than alarms, press *3*. The most recent event will be displayed on the screen. To view all of the selected events, press the up or down arrow keys to scroll through the list of events. If no events have occurred, the display will read *NO EVENTS IN HISTORY*.

Pressing *2* while viewing the History Screen will cause the following screen to be displayed:

```

ERASE HISTORY
PROCEED ?
1=YES          2=NO
  
```

Erase History Screen

Pressing *1* while viewing the Erase History Screen will erase all events from the History file. The display will then return to the History Screen. Pressing *2* will cause the display to return to the History Screen without erasing the History file.

3.6.3 Walktest

To perform a walktest, press *3* while viewing Maintenance Screen #1. The following screen will be displayed:

```

PROGRAMMING
1=INPUT ZONES
2=HISTORY
3=WALKTEST
  
```

Maintenance Screen #1

```

WALKTEST
1=SILENT
2=AUDIBLE
3=VIEW EVENTS
  
```

Walktest Screen

The operator can press *1* to perform a silent walktest or *2* to perform an audible walktest. The display will read *UNIT IN WALKTEST*. To end the Walktest, press the *Esc* (Escape) key.

Pressing *3* after the walktest has been completed, will allow the operator to view the results of the walktest.

3.6.4 Time-Date

To program the time and date into the control panel, press *1* while viewing Maintenance Screen #2. The following display will appear:

```

PROGRAMMING
1=TIME-DATE
  
```

Maintenance Screen #2

```

TIME AND DATE
1=TIME      01:00A
2=DATE      01012009
3=CLOCK FORMAT  12HRS
  
```

Time and Date Screen

To change the time, press *1* to display the following screen:

```

ENTER TIME AS 12HRS
      :
      01:00
1=AM      2=PM
  
```

Time Screen

A flashing cursor will appear on the left side of the display. Enter the four digit number corresponding to the time (0000 - 1259). When the fourth digit is entered, the cursor will move one position to the right. Press *1* for AM or *2* for PM to complete entering the time. The display will return to the Time and Date Screen displaying the new time.

To change the date, press *2* while viewing the Time and Date Screen. The following screen will be displayed:

```

ENTER DATE
**-*--**-*
MONTH DAY YEAR
01-01-2009
  
```

Date Screen

A flashing cursor will appear on the left side of the display. Enter the two digit month, two digit day and four digit year. The cursor will move one position to the right after each entry. When the fourth digit of the year has been entered, the display will return to the Time and Date Screen which will show the new date.

To change between 12 hour and 24 hour format, press *3* for Clock Format while viewing the Time and Date screen. Each press of the *3* key will toggle the display between 12 HR and 24 HR format.

Section 4: Operating Instructions

Factory programmed Templates have been provided to facilitate the installation and configuration of the Fire Alarm Control Panel. The factory default programming for this panel is Template #1. Refer to “FACP Configuration Templates” on page 107 for a detailed description of the FACP operation for Template #1.

4.1 Panel Control Buttons

4.1.1 Acknowledge/Step

The first press of the *Acknowledge/Step* key silences the piezo sounder, changes flashing LEDs to steady and also changes the status field on the LCD display from capital letters to small letters (*TROUBL* to *Troubl*). When the piezo is silenced, an *acknowledge* message is sent to the printer and the history file. *Acknowledge* also sends a *silence piezo* command to the optional annunciators connected to the FACP. The Acknowledge key will have no effect on the Notification Appliance Circuits.

When more than one event exists, the first press of the Acknowledge/Step key functions as described in the preceding paragraph. Subsequent pressing of the key *steps* through each active event.

4.1.2 Alarm Silenced

The *Alarm Silenced* key performs the same functions as Acknowledge/Step, except it will not step through each event when multiple events are present at the panel. In addition, if an alarm exists, it turns off all silenceable NACs (Notification Appliance Circuits) and causes the Alarm Silenced indicator to turn on. It also sends an ‘alarm silenced’ message to the printer, history file and optional annunciators. A subsequent new alarm will resound the system NACs. The Alarm Silenced indicator is turned off by pressing the Reset key, the Drill key or subsequent activation of the NACs.



NOTES:

1. If Silence Inhibit has been enabled, NACs cannot be silenced for one minute following initiation of an alarm.

When the system is configured for dual hazard operation, an alarm in one hazard area may reactivate notification appliance circuits programmed for that area only.

4.1.3 Drill/Hold 2 Sec

When the *Drill* key is held for a minimum of two seconds (time required to prevent accidental activations), the FACP turns on all NAC outputs and turns off the Alarm Silenced indicator if it was previously on. The *EVAC IN SYSTEM* message is shown on the LCD display. The same message is sent to the printer and history file. The *Alarm Silence* key can be used to turn off all silenceable NAC outputs following activation by the *Drill* key.

4.1.4 Reset

Pressing and releasing the *Reset* key turns off all NACs, temporarily turns off resettable power to 4-wire detectors, causes a *RESET IN SYSTEM* message to be displayed on the LCD and sends the same message to the printer and history file. It also performs a lamp test by turning on all LEDs, piezo sounder and LCD display segments after the *Reset* key is released. Any alarm or trouble that exists after a reset will resound the system.

Note that if Silence Inhibit has been enabled, the FACP cannot be reset for one minute following initiation of an alarm.

4.2 Indicators

The six indicators, which are located on the front panel, operate as follows:

AC Power

This is a green indicator which illuminates if AC power is applied to the FACP. A loss of AC power will turn off this indicator.

Fire Alarm

This red indicator flashes when one or more alarms occur. It illuminates steady when the *Acknowledge/Step* or *Alarm Silence* key is pressed. The Fire Alarm indicator turns off when the *Reset* key is pressed. The indicator will remain off if all alarms have been cleared.

Supervisory

This is a yellow indicator that flashes when one or more supervisory conditions occur, such as a sprinkler valve tamper condition. It illuminates steady when the *Acknowledge/Step* or *Alarm Silence* key is pressed. It turns off when the *Reset* key is pressed and remains off if all supervisory alarms have been cleared.

Trouble

This is a yellow indicator that flashes when one or more trouble conditions occur. It stays on steady when the *Acknowledge/Step* or *Alarm Silence* key is pressed. The indicator turns off when all trouble conditions are cleared. This indicator will also illuminate if the microprocessor watchdog circuit is activated.

Alarm Silenced

This is a yellow indicator that illuminates after the *Alarm Silence* key is pressed while an alarm condition exists. It turns off when the *Drill* or *Reset* key is pressed.

Discharge

This is a red indicator that illuminates steadily when the water releasing circuit is activated.

4.3 Normal Operation

With no alarms or troubles in the system, the display message is *System All Normal* along with the current time and date as shown below. To set the time and date, refer to the appropriate section in this manual.

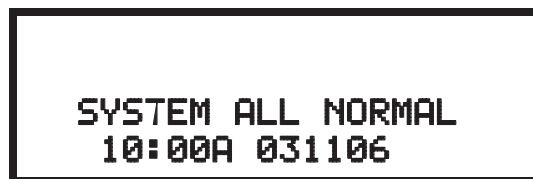

The FACP performs the following functions at regular intervals in Normal mode:

- ✓ Monitors AC input voltage and battery voltage
- ✓ Monitors and reports status option cards and control panel
- ✓ Refreshes LCD display and updates time
- ✓ Scans control panel keypad for key presses
- ✓ Tests memory
- ✓ Updates and reads all communications busses (EIA-485, etc.)

- ✓ i³ smoke detectors will be polled for maintenance and freeze conditions (temperature of 45°F or less) on initial entry into Normal mode. Thereafter, each device will be polled every hour for freeze and every four hours for maintenance conditions



NOTE: To ensure that the system is functioning properly, the FACP will perform a freeze check five minutes after the panel is reset, followed by a maintenance check. If there is no freeze or maintenance condition, the panel will continue to monitor for freeze conditions every hour and maintenance conditions every four hours.

4.4 Trouble Operation

With no alarms in the system, the detection of a trouble will cause the following:

- The piezo pulse 1 second On and 1 second Off
- The system Trouble indicator to flash one second On and one second Off
- The output circuits programmed as Trouble Bell NAC to activate
- The trouble relay to activate
- *TROUBL* with device type, noun/adjective, address and trouble description will appear on the LCD display
- The same message, along with the time and date, is sent to the optional printer and the history buffer.

Note that specific troubles will initiate additional actions; for example, loss of AC power will turn off the AC Power indicator, etc.

Input Zone

For Input Zones, the following is a typical message that could appear on the LCD display for a device trouble:

```

TROUBL PULL STATION
  <ADJ> <NOUN>
ZONE 1 OPEN FAULT
  10:00A 030806
  
```

The information displayed in the above example provides the following information:

- First line in display:
 - ✓ The type of event; in this example *OPEN* indicating a circuit trouble
 - ✓ Device type identifier; in this example, *PULL STATION* indicates a manual device. Other device type identifiers which can be displayed include *2-WIRE SMOKE* for Smoke Detector, *2-WIRE HEAT* for Heat Detector, etc.
- Second line in display:
 - ✓ <ADJ>; refers to the user programmed adjective descriptor from library list resident in the control panel or custom entry via PC.
 - ✓ <NOUN>; refers to the user programmed noun descriptor from library list resident in the control panel or custom entry via PC.
- Third line in display indicates Zone and the fault condition. Other possible troubles include:
 - *OPEN* - indicating an open circuit
 - *DIRTY* - maintenance alert indicating that a detector is near but below the allowed alarm limit and is in need of maintenance before the performance is compromised

- Fourth line in display:
 - ✓ Time; the current time in this example is *10:00A* which represents 10:00 AM
 - ✓ Date; the current month, day and year in this example is *03* for March, *08* for the 8th day of the month and *06* for the year 2006

Pressing the *Acknowledge/Step* or *Alarm Silence* key will cause the pulsing piezo to silence and the system Trouble indicator to change from flashing to on steady. This block acknowledgment occurs regardless of the number of troubles, alarms and supervisory events active in the system. When the *Acknowledge/Step* key is pressed and at least one new alarm or trouble exists in the system, the ‘acknowledge’ message is sent to the printer and history file. If the trouble clears, either before or after the *Acknowledge/Step* key is pressed, the ‘clear trouble’ message is sent to the printer and history file.

If all troubles clear and there are no supervisory or fire conditions active in the system, the system returns to normal mode operation and the *System All Normal* message is shown on the LCD display and sent to the history and printer files. The auto-restore feature will restore cleared troubles even if the troubles were never acknowledged. Note that pressing the *Alarm Silence* key when only troubles exist in the system will have the same effect as pressing the *Acknowledge/Step* key except the Alarm Silenced indicator will light.

4.5 Alarm Operation

For a detailed description of the alarm operation for each preprogrammed Template, refer to “FACP Configuration Templates” on page 107 and “Circuit Mapping and Cross-Zoning” on page 102. Alarm operation is similar to trouble operation with the following differences:

- The piezo sounder produces a steady output as opposed to a pulsed output
- The Fire Alarm indicator flashes 1 second On and 1 second Off
- The LCD displays *Alarm* along with the device name, type, adjective/noun, associated zones and time/date
- Alarms latch and *are not allowed to clear automatically*
- Timers for Silence Inhibit, Autosilence and Trouble Reminder are started
- Soak and Waterflow Delay Timers are started (if enabled) for appropriate circuits
- Alarms activate the general alarm relay
- Silenced alarms are resounded
- Release Solenoid circuits are activated to produce a water release
- The trouble relay is not activated
- Store event in history buffer

A typical alarm display would be as illustrated below:

```

ALARM  PULL STATION
      <ADJ> <NOUN>
ZONE 1
 10:00A 030809
  
```

Note that the device type, which in this example is *PULL STATION*, can be any other programmable alarm type.

The information displayed in the above example provides the following information:

- First line in display:
 - ✓ The type of event; in this example *ALARM* indicating an alarm condition
 - ✓ Device type identifier; in this example, *PULL STATION* indicates a manual pull box. Other device type identifiers which can be displayed include *2-WIRE SMOKE* for Smoke Detector, *2-WIRE HEAT* for Heat Detector, etc.

- Second line in display:
 - ✓ <ADJ>; refers to the user programmed adjective descriptor from library list resident in the control panel or custom entry via PC.
 - ✓ <NOUN>; refers to the user programmed noun descriptor from library list resident in the control panel or custom entry via PC.
- Third line in display: *Zone 1* indicates the zone programmed to this device which, in this example, is Input Zone 1.
- Fourth line in display:
 - ✓ Time; the current time in this example is *10:00A* which represents 10:00 AM
 - ✓ Date; the current month, day and year in this example is *03* for March, *08* for the 8th day of the month and *09* for the year 2009

4.6 Supervisory Operation

Supervisory operation is similar to alarm operation but with the following differences:

- The piezo sounder pulses ½ second On and ½ second Off
- The Supervisory indicator flashes ½ second On and ½ second Off
- The LCD displays the status label *Active Supervisory* along with the device name, type, adjective/noun, associated zones and time/date
- The output circuits programmed as Supervisory NAC are activated
- The supervisory relay is activated
- The alarm relay is not activated
- Silenced alarms are not resounded
- Timers are not started
- Store event in history buffer

A typical Supervisory event would be displayed as illustrated in the following:

```

FREEZE SUPERVISORY
  <ADJ> <NOUN>
ZONE 05 FROZEN SUPRV
10:00A 030806
```

In the preceding example:

- *FROZEN SUPRV* - indicates zone detector is below approximately 45°F

Note that, like alarms, supervisory signals latch (except when programmed for supervisory autoresettable). Supervisory alarms do not cause resound as do other alarm conditions. Open circuits in supervisory wiring are processed by the control panel the same way as other trouble conditions. Refer to “Alarm Operation” on page 87, for a description of the information displayed on the control panel LCD.

4.7 Disable/Enable Operation

Input zones which are disabled do not cause an alarm or any zone activation. Disabled NACs are held in the off state. Disabled zones/NACs are treated as if they were in trouble, with the exception being the LCD status label that will be displayed is *DISABL*.

Note that disabled Releasing Circuits are treated as **supervisory** events.

4.8 Waterflow Circuits Operation

If an alarm exists from a zone that is a waterflow non-silenceable type, the Alarm Silence key will not function.

4.9 2nd-Shot Water Switch

Following an initial waterflow release, an input circuit with the nonlatching Type Code of 2nd-Shot Water Switch, when activated, will cause another waterflow release to occur immediately. If a manual switch is connected to the circuit, an operator has the option to perform any number of additional waterflow releases following an initial release.

4.10 Detector Functions

Maintenance Alert

i³ smoke detectors will be polled for maintenance and freeze conditions (temperature less than 45°F) on initial entry into Normal mode. Thereafter, each device will be polled every hour for freeze and every four hours for maintenance conditions. All alarm and system trouble conditions are annunciated on the control panel's LCD.



NOTE: To ensure that the system is functioning properly, the FACP will perform a freeze check five minutes after the panel is reset, followed by a maintenance check. If there is no freeze or maintenance condition, the panel will continue to monitor for freeze conditions every hour and maintenance conditions every four hours.

Time Functions: Real-Time Clock

The FACP includes a crystal-based clock that provides time of day, date and day of week. Time is displayed as 12 or 24 hour time with month/day/year and is stored in RAM. Daylight savings time change-over is programmable and automatic. If both AC and battery are lost, the time must be reprogrammed.

4.11 Coded NAC Operation

The NAC circuits resident on the control panel main circuit board can be programmed for coded operation. The available options which can be programmed for coded operation are as follows:

- Steady - Steady output with no pulsing
- March Time - Pulses at 120 ppm (pulses per minute)
- California Code - 10 seconds On, 5 seconds Off
- Temporal Code - Pulses at ½ second On, ½ second Off, ½ second On, ½ second Off, ½ second On, 1½ second Off
- Cross-Zone:
 - ✓ 1st zone of a cross-zoned group in alarm causes programmed NAC output to pulse 1 second on and 1 second off
 - ✓ 2nd zone of a cross-zoned group in alarm causes programmed NAC output to pulse ½ second on and ½ second off - *Note: if more than three zones are cross-zoned, the programmed NAC output will continue to pulse ½ second on and ½ second off for each subsequent zone in alarm, until the final zone in the cross-zoned group goes into alarm*
 - ✓ all zones of a cross-zoned group in alarm causes the output programmed as a Releasing Circuit to perform a water release and the programmed NAC output to turn on steady

- Synchronized output for System Sensor, Wheelock, Gentex, Faraday or Amseco - Refer to “Synchronized NAC Operation” on page 61 for additional information.

4.12 Release Stages

Outputs programmed as Release Stage NACs indicate the two stages of a release operation:

- ✓ the activation of an output programmed as a Releasing Circuit will cause the programmed indicating NAC output to turn on steady
- ✓ upon completion of the release, the programmed indicating NAC output will pulse at a 20 pulse-per-minute rate

4.13 Special System Timers

4.13.1 Silence Inhibit Timer

This option, if selected, prevents the *Alarm Silence* key from functioning for 60 seconds following an alarm. A new alarm during the initial 60 second period will not cause the timer to restart with a new 60 seconds. *Silence Inhibit operation requires the approval of the local AHJ.*

4.13.2 Autosilence Timer

If Autosilence is selected, the notification appliances, programmed as silenceable, will automatically be silenced after a programmable duration of from 5 to 30 minutes. Pressing the *Drill* key will restart the timer. *Autosilence operation requires the approval of the local AHJ.*

4.13.3 Trouble Reminder

If selected, this feature causes a reminding ‘beep’ every 15 seconds during an alarm (after the *Alarm Silence* key is pressed) and every two minutes during a trouble condition (after the *Acknowledge/Step* or *Alarm Silence* key is pressed). The ‘beeps’ from the onboard piezo sounder will occur until the alarm or fault is cleared.

Note that if Trouble Reminder feature is not selected and the trouble is not cleared within 24 hours, the piezo will resound, indicating that the trouble condition still exists.

4.13.4 Soak Timers

Two Soak Timers allow the user to program a time between 10 and 30 minutes for each water releasing circuit to remain active. Soak Timer 1 is used for Releasing Solenoid Circuit 1 and Soak Timer 2 is used for Releasing Solenoid Circuit 2. Following an alarm condition in which the releasing circuit is activated, the water release will stop when the corresponding Soak Timer reaches zero.

4.13.5 Waterflow Delay Timer

If selected, this option will delay the activation of a waterflow type alarm for a programmable time duration from 1 to 90 seconds. This delay is in addition to any time delay inherent in the waterflow device. *This feature requires the approval of the local AHJ.*

4.14 Walktest

Walktest is a feature which allows one person to test the fire alarm system. An audible walktest will momentarily sound the Notification Appliance Circuits in the building and store the walktest information in a file at the panel. A silent walktest will not sound the NACs but will store the

walktest information in a file which can be viewed at the panel. Disabled NAC devices will not activate during walktest. In addition, i³ smoke detectors will enter their own test mode causing their LEDs to flash twice every five seconds (refer to i³ specification document).

Alarm/Shorted Condition

When in audible Walktest, the panel responds to each new alarm and activates its programmed control outputs for four seconds, if those outputs have been programmed for silenceable activation. It also stores each alarm in the walktest history file which can be sent to an optional printer. The stored display will be the same as if the device actually activated except the colon (:) in the time stamp is replaced with an asterisk (*).

Open Condition

Initiating Device Circuits as well as all main circuit board NACs are monitored for fault conditions during Walktest mode. When a new trouble condition occurs, the FACP will activate all NACs programmed for Walktest, then shut them off after eight seconds.

While in Walktest, the trouble relay is activated and the system Trouble indicator flashes (as in all of the Program and status change operations). The alarm relay is not activated.

4.15 Read Status

Read Status functions do not require a password. The control panel will continue to provide fire protection while in Read Status mode. This mode can be entered while the control panel is in alarm or trouble. If a new alarm occurs during these functions, the Read Status is exited to prevent confusion.

Read Status Entry

When the operator presses the control panel *Enter* key, the LCD will display the following:



```
1=READ STATUS MODE
2=PROGRAMMING MODE
```

Pressing *1*, while this screen is being displayed, will cause the control panel to enter the Read Status mode which allows the user to view and print the programmed features and status of the control panel.

The following screens will be displayed:

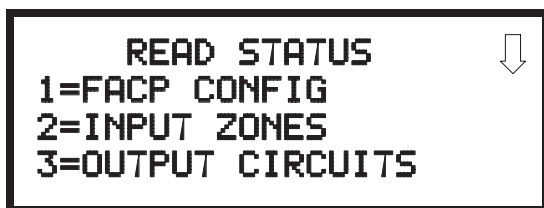

Read Status Screen #1

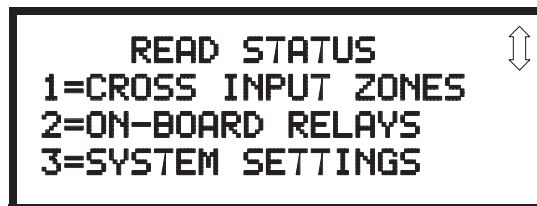

Read Status Screen #2

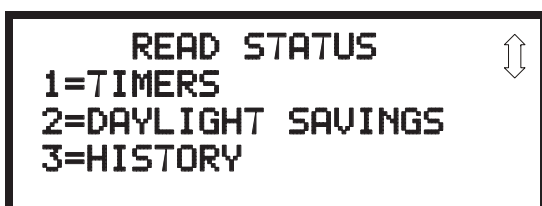

Read Status Screen #3



Read Status Screen #4

4.15.1 FACP Configuration

Pressing *1* while viewing Read Status Screen #1 will display the type of configuration programmed into the FACP (refer to “FACP CONFIG (Application Templates)” on page 49). As an example, if Template 7 was programmed as the FACP configuration, the following screen will be displayed:

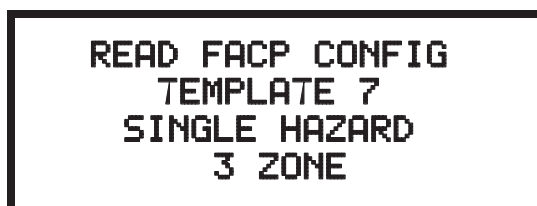

4.15.2 Input Zones

Pressing *2* while viewing Read Status Screen #1 will cause the following screens to be displayed:

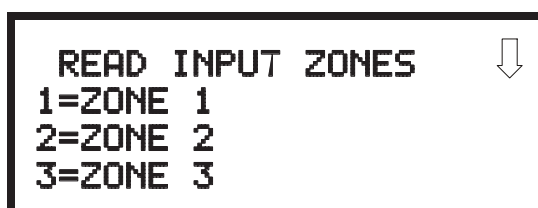

Pressing the down arrow key will allow the selection of Zones 4-6.

The operator selects the zone which is to be viewed by pressing the number corresponding to the desired zone in each screen. For example, if 1 is pressed in the first screen, the display will change to a screen similar to the following:

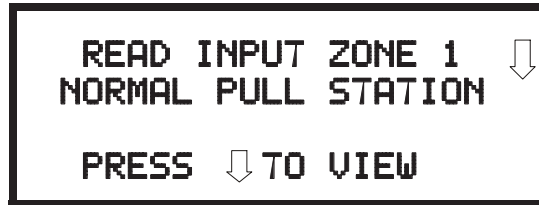

Pressing the down arrow key, while viewing the screen shown above, will allow the operator to view additional programming information about the selected device, such as:

- Enable/Disable Status
- Device Type
- Output Circuit MAP
- Adjective/Noun descriptor

4.15.3 Output Circuits

Pressing 3 while viewing Read Status Screen #1 will display the following screens:

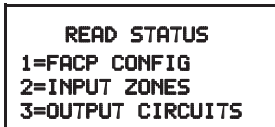

Read Status Screen #1

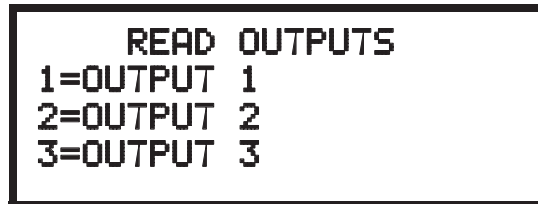

Read Outputs Screen #1

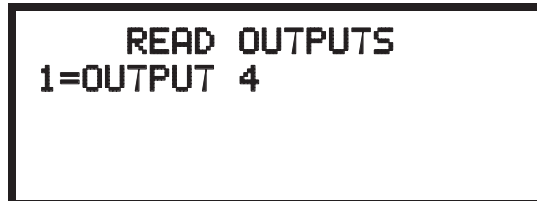

Read Outputs Screen #2

The operator can press 1 to view the programmed options for Output 1, 2 to view the programmed options for Output 2, 3 to view the programmed options for Output 3, or 4 to view the programmed options for Output 4.

The resulting screens will display the following information:

- Enable/Disable Status
- Circuit Type
- Silenceable/Nonsilenceable
- Auto Silence Enable/Disable and time delay (in minutes)
- Silence Inhibit Enabled/Disabled
- Coding Selection (Temporal, Steady, etc.)

4.15.4 Cross Input Zones

READ STATUS
1=CROSS INPUT ZONES
2=ON-BOARD RELAYS
3=SYSTEM SETTINGS

Read Status Screen #2

Pressing *1* while viewing Read Status Screen #2 will display the following screens:

```

CROSS INPUT ZONES
1=RELEASE 1
2=RELEASE 2
  
```

Cross Input Zone Screen

Pressing *1* for Release 1 or *2* for Release 2 will display the cross-zoning, if any, for the selected Releasing Circuit as illustrated in the following screen:

```

CROSS ZONE REL 1
X 1 4
  NONE
  NONE
  
```

Cross Input Zone Screen

The Cross Zone Release screen displays the zones that have been cross-zoned. In this example, Zone 1 is cross-zoned with Zone 4.

4.15.5 On-Board Relays

Pressing *2* while viewing Read Status Screen #2 will display the following screen:

```

ON-BOARD RELAYS
1=RELAY 1
2=RELAY 2
3=RELAY 3
  
```

To view the information about a relay, press the number key corresponding to the desired relay. The following screen will be displayed:

```

          RELAY #
TYPE      ALARM
LATCHING      NO
  
```

4.15.6 System Settings

Pressing 3 while viewing Read Status Screen #2 will display the following screens:

```

SYSTEM SETTINGS  ↓
FUTURE USE
TROUBLE REMIND   NO
CHARGER DISABLE  NO
  
```

```

SYSTEM SETTINGS  ↑↓
FACTORY BANNER
  
```

```

SYSTEM SETTINGS  ↑
CANADIAN OPTION  NO
  
```

The operator can view the system settings options that have been programmed into the FACP.

4.15.7 Timers

Pressing 1 while Read Status Screen #3 will display the following screens:

```

READ STATUS
1=TIMERS
2=DAYLIGHT SAVINGS
3=HISTORY
  
```

Read Status Screen #3

```

          TIMERS  ↓
SOAK  1      10 MIN
SOAK  2      10 MIN
WATERFLOW DELAY  0 S
  
```

```

          TIMERS  ↑
AC LOSS DELAY    2 HR
  
```

These screens allow the operator to view the various timer settings.

4.15.8 Daylight Savings

Pressing 2 while Read Status Screen #3 will cause the following screens to be displayed:

```

DAYLIGHT SAVINGS ↓
ENABLED           YES
START MONTH      MAR
START WEEK       WK 2
  
```

```

DAYLIGHT SAVINGS ↑
END MONTH        NOV
END WEEK         WK 1
  
```

These screens allow the operator to view settings that have been programmed for Daylight Savings Time.

4.15.9 History

Pressing 3 while viewing Read Status Screen #3 will display the following screens:

```

HISTORY
1=VIEW ALL
2=VIEW ALARMS
3=VIEW OTHER EVENTS
  
```

The operator can view all events which have been stored in the history file, only alarms or other events, such as troubles or supervisories, by pressing the corresponding number key.

4.15.10 Print

```

READ STATUS
1=PRINT
2=ANN-BUS
  
```

Read Status Screen #4

To print control panel data, press 1 while viewing Read Status Screen #4. This allows printing to the printer connected to the N-ANN-S/PG module. The following screens will be displayed:

```

PRINT
1=HISTORY
2=WALKTEST LOG
3=EXIT PRINTING
  
```



Pressing *1* allows the user to print the History file which will detail all of the system activities since the file was last cleared from memory.

Pressing *2* allows the user to print the Walktest log which will detail all of the system activations during walktest since the log was last cleared. Refer to “Walktest” on page 78 for additional information on the display.

Pressing *3* will exit the Print operation.

4.15.11 ANN-BUS

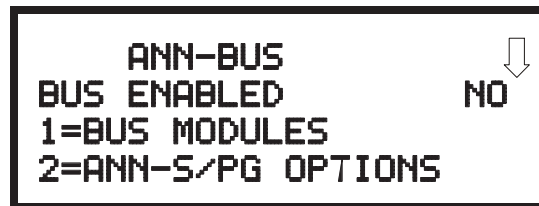
Pressing *2* while viewing Read Status Screen #4 will display the settings for the ANN-BUS options as shown in the following screens:



ANN-BUS Screen #1

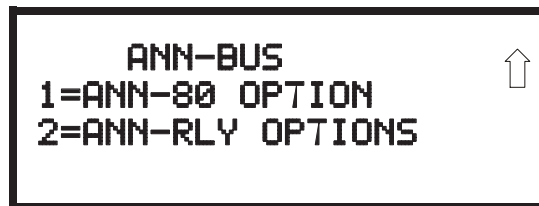

ANN-BUS Screen #2

ANN-BUS Screen #1 indicates whether the ANN-BUS is enabled (Yes/No).

Pressing *1* while viewing ANN-BUS Screen #1 will display BUS Module addresses 1-8 and the devices, if any, located at those addresses.

Pressing *2* while viewing ANN-BUS Screen #1 will display the programmed options for the N-ANN-S/PG Module devices connected to the ANN-BUS.

Pressing *1* while viewing ANN-BUS Screen #2 will display the programmed options for the N-ANN-80 LCD annunciators connected to the ANN-BUS.

Pressing *2* while viewing ANN-BUS Screen #2 will display the programmed options for the N-ANN-RLY devices connected to the ANN-BUS.



NOTE: The N-ANN-I/O and N-ANN-LED modules do not require any additional programming configuration.

Section 5: Power Supply Calculations

5.1 Overview

This section contains instructions and tables for calculating power supply currents in alarm and standby conditions. This is a four-step process, consisting of the following:

1. Calculating the total amount of AC branch circuit current required to operate the system
2. Calculating the power supply load current for non-fire and fire alarm conditions and calculating the secondary (battery) load
3. Calculating the size of batteries required to support the system if an AC power loss occurs
4. Selecting the proper batteries for your system

5.2 Calculating the AC Branch Circuit

The control panel requires connection to a separate, dedicated AC branch circuit, which must be labeled **FIRE ALARM**. This branch circuit must connect to the line side of the main power feed of the protected premises. No other non-fire alarm equipment may be powered from the fire alarm branch circuit. The branch circuit wire must run continuously, without any disconnect devices, from the power source to the control panel. Overcurrent protection for this circuit must comply with Article 760 of the National Electrical Codes as well as local codes. Use 14 AWG (2.00 mm²) wire with 600 volt insulation for this branch circuit.

Use Table 5.1 , to determine the total amount of current, in AC amperes (A), that must be supplied to the system.

Device Type	Number of Devices		Current Draw (AC amps)		Total Current per Device
RP-2001/C or RP-2001E	1	X	3.66 or 2.085	=	
	[]	X	[]	=	
	[]	X	[]	=	
Sum Column for AC Branch Current Required				=	

Table 5.1 AC Branch Circuit Requirements

5.3 Calculating the System Current Draw

5.3.1 Overview

The control panel must be able to power all internal and external devices continuously during the non-fire alarm condition. To calculate the non-fire alarm load on the system power supply when primary power is applied, use Calculation Column 1 in Table 5.3 on page 100. The control panel must support a larger load current during a fire alarm condition. To calculate the fire alarm load on the power supply, use Calculation Column 2 in Table 5.3 on page 100. The secondary power source (batteries) must be able to power the system during a primary power loss. To calculate the non-fire alarm load on the secondary power source, use Calculation Column 3 in Table 5.3 on page 100.

When calculating current draw and the battery size, note the following:

- ‘Primary’ refers to the main power source for the control panel
- ‘Secondary’ refers to the control panel’s backup batteries
- All currents are given in amperes (A). Table 5.2 shows how to convert milliamperes and microamperes to full amperes.

To convert...	Multiply	Example
Milliamperes (mA) to amperes (A)	$\text{mA} \times 0.001$	$3 \text{ mA} \times 0.001 = 0.003\text{A}$
Microamperes (μA) to amperes (A)	$\mu\text{A} \times 0.000001$	$300 \mu\text{A} \times 0.000001 = 0.0003 \text{ A}$

Table 5.2 Converting to Full Amperes

5.3.2 How to Use Table 5.3 on page 100 to Calculate System Current Draw

Use Table 5.3 on page 100 to calculate current draws as follows:

1. Enter the quantity of devices in all three columns.
2. Enter the current draw where required. Refer to the Device Compatibility Document for compatible devices and their current draw.
3. Calculate the current draws for each in all columns.
4. Sum the total current for each column.
5. Copy the totals from Column 2 and Column 3 to Table 5.4 on page 101.

Following are the types of current that can be entered into Table 5.3 on page 100:

- ✓ **Calculation Column 1** - The primary supply current load that the control panel must support during a non-fire alarm condition, with AC power applied.
- ✓ **Calculation Column 2** - The secondary supply current load that the control panel must support during a fire alarm condition.
- ✓ **Calculation Column 3** - The standby current drawn from the batteries in a non-fire alarm condition during a loss of AC power.

Table 5.3 contains three columns for calculating current draws. For each column, calculate the current and enter the total (in amperes) in the bottom row. When finished, copy the totals from Calculation Column 2 and Calculation Column 3 to Table 5.4 on page 101.

Device Type	Calculation Column 1 Primary, Non-Fire Alarm Current (amps)			Calculation Column 2 Secondary, Fire Alarm Current (amps)			Calculation Column 3 Secondary, Non-Fire Alarm Current (amps)		
	Qty	X [current draw]=	Total	Qty	X [current draw] =	Total	Qty	X [current draw]=	Total
Main Circuit Board	1	X[0.122]=	0.122	1	X[0.185] ^{1, 2} =	0.185	1	X[0.122]=	0.122
N-CAC-5X	[]	X[0.001]=		[]	X[0.001]=		[]	X[0.001]=	
4XTM	[] (1 max.)	X[0.005]=		[]	X[0.011] ¹ =		[]	X[0.005]=	
N-ANN-80	[]	X[0.037]=		[]	X[0.040]=		[]	X[0.015]=	
N-ANN-I/O	[]	X[0.035]=		[]	X[0.200]=		[]	X[0.035]=	
N-ANN-RLY	[]	X[0.015]=		[]	X[0.075]=		[]	X[0.015]=	
N-ANN-(R)LED	[]	X[0.028]=		[]	X[0.068]=		[]	X[0.028]=	
N-ANN-S/PG	[]	X[0.045]=		[]	X[0.045]=		[]	X[0.045]=	
2-wire Detector Heads	[]	X[] ³ =		[] ⁴	X[0.040]=		[]	X[] ³ =	
4-wire Detector Heads	[]	X[] ³ =		[] ⁴	X[0.040]=		[]	X[] ³ =	
Power Supervision Relays ⁵	[]	X[0.025]=		[]	X[0.025]=		[]	X[0.025]=	
NAC #1 ⁶				[]	X[]=				
NAC #2				[]	X[]=				
NAC #3									
NAC #4									
Current Draw from TB9 (nonalarm ⁷)	[]	=		[]	=		[]	=	
Sum each column⁸ for totals	Primary Non-Alarm =			Secondary Alarm =			Secondary Non-Alarm =		

Table 5.3 System Current Draw Calculations

- 1 If using the Reverse Polarity Alarm output, add 0.005 amps; if using the Reverse Polarity Trouble output, add another 0.005 amps.
- 2 The current shown represents one zone (IDC) on the main circuit board in alarm. One zone consumes 0.040 amps.
- 3 Refer to the Device Compatibility Document for standby current.
- 4 Enter the number of IDCs used minus one.
- 5 Must use compatible listed Power Supervision Relay.
- 6 Current limitation of Terminal TB5 circuits is 3.0 amps per NAC
- 7 The total standby current must include both the resettable (TB9 Terminals 3 & 4) and nonresettable/resettable (TB9 Terminals 1 & 2) power. Caution must be taken to ensure that current drawn from these outputs during alarm does not exceed maximum ratings specified. Current limitations of TB9, Terminals 1 & 2 = 0.500 amps, filtered, 24 VDC +/-5%, 120 Hz ripple @ 10 mV_{RMS}, nonresettable power and TB9, Terminals 3 & 4 = 0.500 amps, filtered, 24 VDC +/-5%, 120 Hz ripple @ 10mV_{RMS}, resettable power.
- 8 Total current draw listed above cannot exceed 7.0 amps

5.4 Calculating the Battery Size

Use Table 5.4 to calculate the total Standby and Alarm load in ampere hours (AH). This total load determines the battery size (in AH), required to support the control panel under the loss of AC power. Complete Table 5.4 as follows:

1. Enter the totals from Table 5.3 on page 100, Calculation Columns 2 and 3 where shown
2. Enter the NFPA Standby and Alarm times (refer to 'NFPA Requirements' below)
3. Calculate the ampere hours for Standby and Alarm, then sum the Standby and Alarm ampere hours
4. Multiply the sum by the derating factor of 1.2 to calculate the proper battery size (in AH)
5. Write the ampere hour requirements on the Protected Premises label located inside the cabinet door

Secondary Standby Load (total from Table 5.3 Calculation Column 3) []	Required Standby Time (24 hours) X[]	= AH
Secondary Alarm Load (total from Table 5.3 Calculation Column 2) []	Required Alarm Time (for 5 min., enter 0.084, for 10 min., enter 0.168) X[]	= AH
Sum of Standby and Alarm Ampere Hours		= AH
Multiply by the Derating Factor		X 1.2
Battery Size, Total Ampere Hours Required		= AH

Table 5.4 Total Secondary Power Requirements at 24 VDC

5.4.1 NFPA Battery Requirements

NFPA 72 Local, Central and Proprietary Fire Alarm Systems require 24 hours of standby power followed by 5 minutes in alarm

5.4.2 Selecting and Locating Batteries

Select batteries that meet or exceed the total ampere hours calculated in Table 5.4. The control panel can charge batteries in the 7 AH to 26 AH range. The control panel cabinet is capable of housing batteries up to 18 AH. Batteries larger than 18 AH require the NFS-LBB or other UL listed external battery cabinet.

For Canadian Applications, the minimum battery size is 12 AH and the maximum battery size is 18 AH.

Appendix A: Circuit Mapping and Cross-Zoning

A.1 Input-to-Output Circuit Mapping and Cross-Zone Operation

The flexible cross-zoning and input-to-output (I/O) mapping capability of this fire panel provides a powerful toolset to accommodate many site-specific configurations. To simplify initial setup, preconfigured application templates that employ cross-zoning and I/O mapping are included from the factory. Refer to “FACP Configuration Templates” on page 107 for a description of each supplied template.

The following sections provide some examples of setting up your own cross-zoned or I/O mapped system.

The Installer is responsible for completely testing the proper operation of the fire panel as set up by programming.



NOTES:

1. Any general system trouble, such as a battery fault, will activate any output circuit programmed as *TROUBLE NAC* in the *OUTPUT CIRCUITS* menu. Circuit mapping does not apply.
 2. Any input zone programmed for supervisory operation or as a *DISABLE RELEASE* switch in the *INPUT CIRCUITS* menus will activate any output circuit programmed as *SUPV BELL NAC* in the *OUTPUT CIRCUITS* menus. Circuit mapping does not apply.
 3. The programming menus will prevent you from mapping any incompatible input zone and output circuit types together, such as mapping a supervisory input zone to a releasing output circuit.
 4. Timers and/or delays are not represented in these examples.
-

A.1.1 Mapping Input Zones to Output Circuits for Direct Activation

Using the INPUT ZONES menus, you can assign any input zone to directly activate (without cross-zoning) any of the four output circuits provided they are assigned matching operational types (see the OUTPUT CIRCUIT MAP menu within the INPUT ZONES menus).

Example 1: A waterflow input zone assigned to directly activate an alarm output circuit by setting the OUTPUT CIRCUIT MAP assignment to YES.

- Output Circuit 1 is programmed as alarm NAC using the *OUTPUT CIRCUITS* menus.
- Output Circuit 2 is programmed as Release Circuit 1 using the *OUTPUT CIRCUITS* menus.
- Output Circuit 3 is programmed as Release Circuit 2 using the *OUTPUT CIRCUITS* menus.
- Output Circuit 4 is programmed as supervisory NAC using the *OUTPUT CIRCUITS* menus.
- Input Zone 1 is programmed as a waterflow zone using the *INPUT ZONES* menus.

Waterflow Input Zone 1 will directly activate Output Circuit 1 (Alarm NAC) but not Output Circuits 2, 3 or 4.

ZONE 1 TYPE	
1=N/A	
2=N/A	
3=WATERFLOW	

OUTPUT MAP ZONE 1	
1=ALARM NAC	YES
2=RELEASE 1	NO
3=RELEASE 2	NO

OUTPUT MAP ZONE 1	
1=SUPV BELL NAC	N/A

Example 2: A single hazard application where a smoke detector input zone will directly activate both an alarm NAC circuit and a releasing output circuit.

- Output Circuit 1 is programmed as alarm NAC using the *OUTPUT CIRCUITS* menus.
- Output Circuit 2 is programmed as Release Circuit 1 using the *OUTPUT CIRCUITS* menus.
- Output Circuit 3 is programmed as waterflow NAC using the *OUTPUT CIRCUITS* menus.
- Output Circuit 4 is programmed as supervisory NAC using the *OUTPUT CIRCUITS* menus.
- Input Zone 1 is programmed as a smoke detector zone using the *INPUT ZONES* menus.

Smoke detector Input Zone 1 will directly activate Output Circuits 1 (Alarm NAC) and 2 (Release 1) but not output circuits 3 or 4.

ZONE 1 TYPE	
1=2-WIRE SMOKE	
2=2-WIRE HEAT	
3=N/A	

OUTPUT MAP ZONE 1	
1=ALARM NAC	YES
2=RELEASE 1	YES
3=WATERFLOW NAC	NO

OUTPUT MAP ZONE 1	
1=SUPV BELL NAC	N/A

A.1.2 Mapping Input Zones to Release Circuits for Cross Zone Activation

Using the *OUTPUT CIRCUITS* menus, this fire panel will allow you to assign a release circuit *type* of operation to any two of the four output circuits. Up to two releasing circuits (or hazards), called RELEASE 1 and RELEASE 2, may be created. Input zones may be assigned in various ways to activate either one or both of the release circuits. The fire panel treats RELEASE 1 and RELEASE 2 functions independently from each other, although they may share input circuits for activation.

Cross-zoning is set up in the *CROSS INPUT ZONES* menus, where you can create up to three groups of input zones for each release circuit. When cross zone groups have been set up, the *OUTPUT CIRCUIT MAP* associated with the input zones will automatically show *YES* for release output circuits. This extremely flexible cross-zone with grouping capability is used in the following examples.

Example 3: A single hazard, cross-zoned application using two smoke detector input zones and one releasing output circuit. Input Zones 1 and 2 are cross-zoned to activate output circuit 2, which is programmed as a RELEASE 1.

- Output Circuit 1 is programmed as alarm NAC using the *OUTPUT CIRCUITS* menus.
- Output Circuit 2 is programmed as Release Circuit 1 using the *OUTPUT CIRCUITS* menus.
- Output Circuit 3 is programmed as alarm NAC using the *OUTPUT CIRCUITS* menus
- Output Circuit 4 is programmed as supervisory NAC using the *OUTPUT CIRCUITS* menus.
- Either of smoke detector Input Zones 1 or 2 will directly activate Output Circuit 1 (Alarm NAC).
- Smoke detector Input Zone 2 will also directly activate Output Circuit 3 (Alarm NAC) but not Output Circuits 2 or 4.
- Smoke detector Input Zones 1 and 2 are cross-zoned (both must be in alarm) to activate Output Circuit 2 (Release 1) but not Output Circuit 4.

ZONE 1 TYPE	
1=	2-WIRE SMOKE
2=	2-WIRE HEAT
3=	N/A

ZONE 2 TYPE	
1=	2-WIRE SMOKE
2=	2-WIRE HEAT
3=	N/A

OUTPUT MAP ZONE 1		
1=	ALARM NAC	YES
2=	RELEASE 1	YES
3=	ALARM NAC	NO

OUTPUT MAP ZONE 2		
1=	ALARM NAC	YES
2=	RELEASE 1	YES
3=	ALARM NAC	YES

OUTPUT MAP ZONE 1		
1=	SUPV BELL NAC	N/A

OUTPUT MAP ZONE 2		
1=	SUPV BELL NAC	N/A

REL 1 CROSS GROUP 1		
1=	ZONE 1	YES
2=	ZONE 2	YES
3=	ZONE 3	NO

Example 4: A dual hazard, cross-zoned application using four input zones and two releasing output circuits. Input Zones 1 and 2 are cross-zoned to activate Output Circuit 2, which is programmed as RELEASE 1. Input Zones 3 and 4 are cross-zoned to activate Output Circuit 3, which is programmed as a RELEASE 2.

- Output Circuit 1 is programmed as alarm NAC using the *OUTPUT CIRCUITS* menus.
- Output Circuit 2 is programmed as Release Circuit 1 using the *OUTPUT CIRCUITS* menus.
- Output Circuit 3 is programmed as Release Circuit 2 using the *OUTPUT CIRCUITS* menus
- Output Circuit 4 is programmed as supervisory NAC using the *OUTPUT CIRCUITS* menus.
- Any of smoke detector Input Zones 1 through 4 will directly activate Output Circuit 1 (Alarm NAC) but not Output Circuits 2, 3 or 4.
- Smoke detector Input Zones 1 and 2 are cross-zoned (both must be in alarm) to activate Output Circuit 2 (Release 1) but not Output Circuits 3 or 4.
- Smoke detector Input Zones 3 and 4 are cross-zoned (both must be in alarm) to activate Output Circuit 3 (Release 2) but not Output Circuits 2 or 4.

ZONE 1 TYPE	
1=2-WIRE SMOKE	
2=2-WIRE HEAT	
3=N/A	

ZONE 3 TYPE	
1=2-WIRE SMOKE	
2=2-WIRE HEAT	
3=N/A	

ZONE 2 TYPE	
1=2-WIRE SMOKE	
2=2-WIRE HEAT	
3=N/A	

ZONE 4 TYPE	
1=2-WIRE SMOKE	
2=2-WIRE HEAT	
3=N/A	

OUTPUT MAP ZONE 1	
1=ALARM NAC	YES
2=RELEASE 1	YES
3=RELEASE 2	NO

OUTPUT MAP ZONE 2	
1=ALARM NAC	YES
2=RELEASE 1	YES
3=RELEASE 2	NO

OUTPUT MAP ZONE 1	
1=SUPV BELL NAC	N/A

OUTPUT MAP ZONE 2	
1=SUPV BELL NAC	N/A

OUTPUT MAP ZONE 3	
1=ALARM NAC	YES
2=RELEASE 1	NO
3=RELEASE 2	YES

OUTPUT MAP ZONE 4	
1=ALARM NAC	YES
2=RELEASE 1	NO
3=RELEASE 2	YES

OUTPUT MAP ZONE 3	
1=SUPV BELL NAC	N/A

OUTPUT MAP ZONE 4	
1=SUPV BELL NAC	N/A

REL 1 CROSS GROUP 1	
1=ZONE 1	YES
2=ZONE 2	YES
3=ZONE 3	NO

REL 2 CROSS GROUP 1	
1=ZONE 1	NO
2=ZONE 2	NO
3=ZONE 3	YES

REL 2 CROSS GROUP 1	
1=ZONE 4	YES
2=ZONE 5	NO
3=ZONE 6	NO

A.1.3 Complex Examples of Cross Zoning and I/O Mapping for Release Circuits

Following are some complex examples of cross-zoning for more demanding applications that are possible with this fire panel. Input zone entries in a single cross-zone group are effectively AND'ed together while the cross-zone groups are effectively OR'ed together. For the purpose of describing this, the following *language* is used:

R1	=	RELEASE 1
R2	=	RELEASE 2
Z1	=	INPUT ZONE 1
Z2	=	INPUT ZONE 2
Z3	=	INPUT ZONE 3
Z4	=	INPUT ZONE 4
Z5	=	INPUT ZONE 5
Z6	=	INPUT ZONE 6
OR	=	any input zone may cause a release
AND	=	all input zones must be active for a release

Example 5: Release Circuit 1 activates if either Input Zone 1 or 2 are active in addition to Input Zone 3 being active.

- $R1 = (Z1 \text{ AND } Z3) \text{ OR } (Z2 \text{ AND } Z3)$
- Set Zones 1 and 3 to *YES* in Cross Zoning Group 1 for RELEASE 1 in the *CROSS INPUT ZONES* menus.
- Set Zones 2 and 3 to *YES* in Cross Zoning Group 2 for RELEASE 1 in the *CROSS INPUT ZONES* menus.
- Set all other zones to *NO* in Cross Zoning Groups 1, 2 and 3 for RELEASE 1 in the *CROSS INPUT ZONES* menus.

Example 6: Release Circuit 1 activates if Input Zones 1 and 2 and 3 are all active.

- $R1 = Z1 \text{ AND } Z2 \text{ AND } Z3$
- Set Zones 1, 2 and 3 to *YES* in Cross Zoning Group 1 for RELEASE 1 in the *CROSS INPUT ZONES* menus.
- Set all other zones to *NO* in Cross Zoning Groups 1, 2 and 3 for RELEASE 1 in the *CROSS INPUT ZONES* menus.

Example 7: Release Circuit 1 activates if Input Zones 1 and 2 and 3 are all active. Release Circuit 2 activates if Input Zones 2 and 3 and 4 are all active.

- $R1 = Z1 \text{ AND } Z2 \text{ AND } Z3$
- $R2 = Z2 \text{ AND } Z3 \text{ AND } Z4$
- Set Zones 1, 2 and 3 to *YES* in Cross Zoning Group 1 for RELEASE 1 in the *CROSS INPUT ZONES* menus.
- Set Zones 2, 3 and 4 to *YES* in Cross Zoning Group 1 for RELEASE 2 in the *CROSS INPUT ZONES* menus.
- Set all other zones to *NO* in Cross Zoning Groups 1, 2 and 3 for RELEASE 1 in the *CROSS INPUT ZONES* menus.
- Set all other zones to *NO* in Cross Zoning Groups 1, 2 and 3 for RELEASE 2 in the *CROSS INPUT ZONES* menus.

Example 8: Release Circuit 1 activates if Input Zone 1 activates followed in time by Input Zone 2 activating.

- This kind of sequential reaction is not possible at this time.

Appendix B: FACP Configuration Templates

The RP-2001/E has been provided with preprogrammed templates which allow the user to quickly configure the FACP [refer to “FACP CONFIG (Application Templates)” on page 49]. The user also has the option to reprogram selected portions of the template for customized applications. The following pages of this appendix describe the programming for each of the templates.



NOTE: The RP-2001/E Pre-Action/Deluge Control Panel can be configured using preprogrammed Templates 1 through 7.

Important! Each Template has been programmed with specific Input Zone Types and Output Circuit Types. If the FACP is configured with one of the preprogrammed Templates, the user must ensure that the devices connected to each Input Zone and Output Circuit are compatible with the programmed types. (The user can reprogram the circuit types if desired).

B.1 Template 1: Single Hazard - 3 Zone

Template 1: SINGLE HAZARD - 3 ZONE

	INPUT ZONES					
	1	2	3	4	5	6
OUTPUT CIRCUITS	2-WIRE SMOKE	FIRE	WATERFLOW	MANUAL RELEASE	PULL STATION	SUPV.
#1 ALARM NAC	X	X		X	X	
#2 WATERFLOW NAC			X			
#3 RELEASE SOLENOID 1	X	X		X	X	
#4 SUPV. BELL NAC						X

Table Legend:

X = direct correlation between Input Zone and Output Circuit (input zone activation will turn on corresponding output circuit).

Input Zone Types:

- Zone 1 = 2-wire smoke
- Zone 2 = Fire
- Zone 3 = Waterflow - no waterflow delay since Waterflow Delay Timer is set to 0
- Zone 4 = Manual Release
- Zone 5 = Pull Station
- Zone 6 = Supervisory

Output Circuit Types:

- Output 1 = Alarm NAC, silenceable, coded for steady on
- Output 2 = Waterflow NAC - no waterflow delay since Waterflow Delay Timer is set to 0, silenceable, coded for steady on
- Output 3 = Release Solenoid 1 (unsupervised for shorts)
- Output 4 = Supervisory Bell NAC, silenceable, coded for steady on

Timers

- Soak Timer 1 - set for 10 minutes
- Soak Timer 2 - set for 10 minutes
- Waterflow Delay Timer - set for 0 seconds
- AC Loss Delay Timer - set for 2 hours

Operation

- Activation of Input Zone 1 (2-Wire Smoke) **or** Zone 2 (Fire) **or** Zone 4 (Manual Release) **or** Zone 5 (Pull Station) will operate the Alarm NAC Output #1 and Release Solenoid 1 Output #3. Release Solenoid 1 will turn off water release following time-out of the 10 minute Soak Timer 1
- Activation of Input Zone 3 (Waterflow) will operate the Waterflow NAC Output #2. There is no FACP initiated delay in activation since the Waterflow Delay Timer is set to 0 seconds
- Activation of Input Zone 6 (Supervisory) will operate the Supervisory Bell NAC Output #4

FACP Relay Operation

The following description of FACP relay operations are in addition to normal system operation.

- Alarm Relay - activation of Input Zone 1 (2-Wire Smoke) or Zone 2 (Fire) or Zone 3 (Waterflow - with Waterflow Delay time) or Zone 4 (Manual Release) or Zone 5 (Pull Station) will operate Alarm Relay
- Trouble Relay - any system trouble will activate the Trouble Relay
- Supervisory - activation of Zone 6 (Supervisory) will operate the Supervisory Relay

Device Installation Example for Template 1

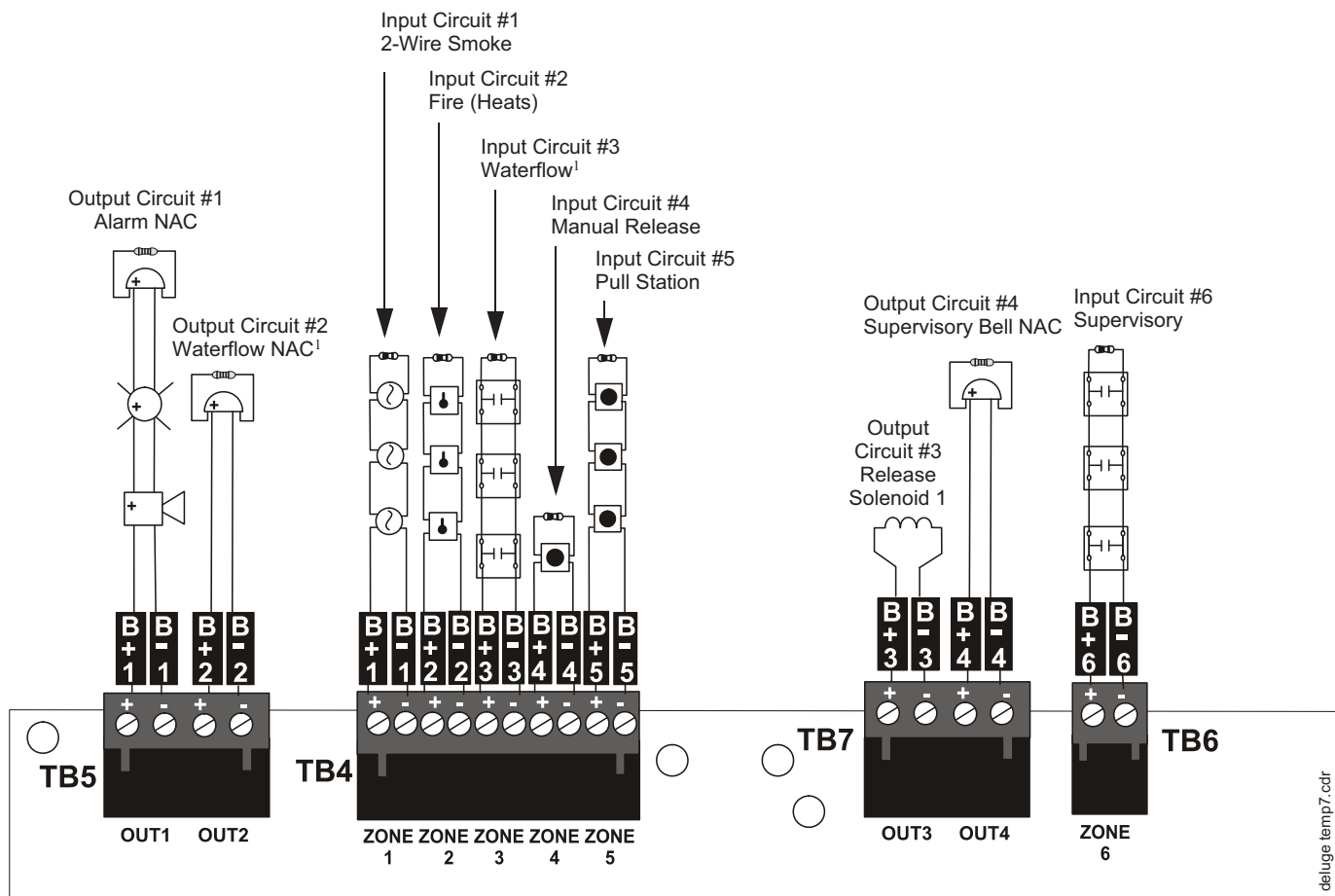

Notes:

1. No Waterflow Delay is programmed.
2. All End-of-Line Resistors, illustrated in this example, are 4.7K Ω , 1/2 watt (PN: 71252).
3. All devices are connected as Class B circuits. For details on connecting as Class A circuits, refer to "N-CAC-5X Class A Converter Module" on page 27.

B.2 Template 2: Single Hazard - Cross-Zone With Manual Release

Template 2: CROSS-ZONE WITH MANUAL RELEASE SWITCH

	INPUT ZONES					
	1	2	3	4	5	6
OUTPUT CIRCUITS	2-WIRE SMOKE	FIRE	WATERFLOW	MANUAL RELEASE	PULL STATION	SUPV.
#1 ALARM NAC	X	X		X	X	
#2 WATERFLOW NAC			X			
#3 RELEASE SOLENOID 1	C1	C1		X	X	
#4 SUPV. BELL NAC						X

Table Legend:

X = direct correlation between Input Zone and Output Circuit (input zone activation will turn on corresponding output circuit).

C_x = cross-zone where x is the number of the Release Solenoid. All inputs with the same Release Solenoid number must be active at the same time to turn on the corresponding solenoid output circuit

Input Zone Types:

- Zone 1 = 2-wire smoke
- Zone 2 = Fire
- Zone 3 = Waterflow - activation delayed for 60 seconds (Waterflow Delay set to 60 secs.)
- Zone 4 = Manual Release
- Zone 5 = Pull Station
- Zone 6 = Supervisory

Output Circuit Types:

- Output 1 = Alarm NAC, silenceable, coded for steady on
- Output 2 = Waterflow NAC - activation delayed for 60 seconds (Waterflow Delay set to 60 sec), silenceable, coded for steady on
- Output 3 = Release Solenoid 1 (unsupervised for shorts)
- Output 4 = Supervisory Bell NAC, silenceable, coded for steady on

Timers

- Soak Timer 1 - set for 10 minutes
- Soak Timer 2 - set for 10 minutes
- Waterflow Delay Timer - set for 60 seconds
- AC Loss Delay Timer - set for 2 hours

Operation

- Activation of both Input Zone 1 (2-Wire Smoke) **and** Zone 2 (Fire) at the same time, **or** Zone 4 (Manual Release) **or** Zone 5 (Pull Station) will operate the Release Solenoid 1 Output #3. Release Solenoid will turn off water release following time-out of the 10 minute Soak Timer 1. Activation of any one of these zones will operate Alarm NAC Output #1
- Activation of Input Zone 3 (Waterflow) will operate the Waterflow NAC Output #2. There is a 60 second FACP initiated delay in activation since Waterflow Delay Timer is set to 60 seconds
- Activation of Input Zone 6 (Supervisory) will operate the Supervisory Bell NAC Output #4

FACP Relay Operation

The following description of FACP relay operations are in addition to normal system operation.

- Alarm Relay - activation of Input Zone 1 (2-Wire Smoke) or Zone 2 (Fire) or Zone 3 (Waterflow - with Waterflow Delay time) or Zone 4 (Manual Release) or Zone 5 (Pull Station) will operate Alarm Relay
- Trouble Relay - any system trouble will activate the Trouble Relay
- Supervisory - activation of Zone 6 (Supervisory) will operate the Supervisory Relay

Device Installation Example for Template 2

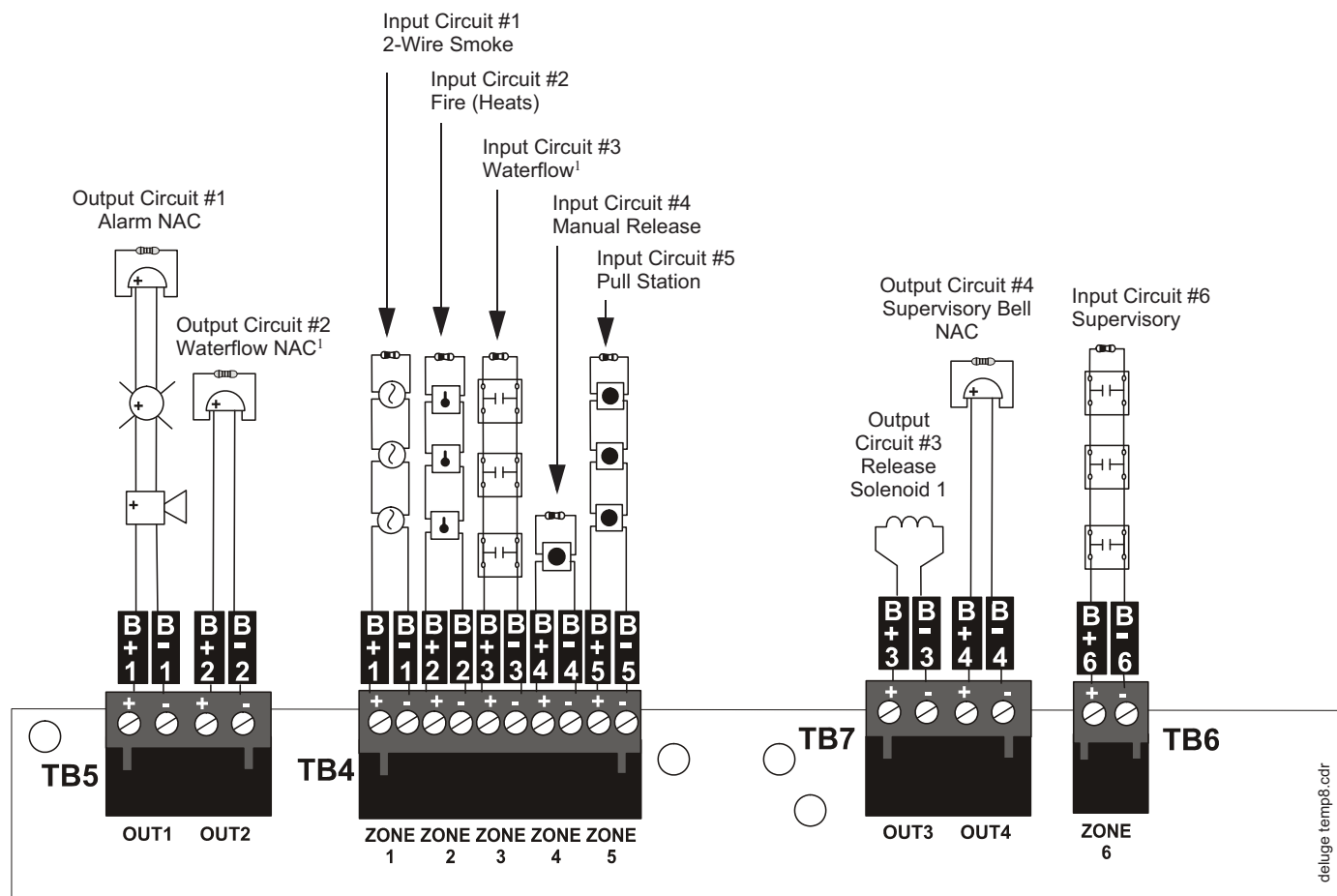

Notes:

1. Waterflow Delay is programmed for 60 seconds.
2. All End-of-Line Resistors, illustrated in this example, are 4.7KΩ, 1/2 watt (PN: 71252).
3. All devices are connected as Class B circuits. For details on connecting as Class A circuits, refer to “N-CAC-5X Class A Converter Module” on page 27.

B.3 Template 3: Dual Hazard - Combined Release

Template 3: DUAL HAZARD - COMBINED RELEASE

	INPUT ZONES					
	1	2	3	4	5	6
OUTPUT CIRCUITS	2-WIRE SMOKE	FIRE	WATERFLOW	MANUAL RELEASE	PULL STATION	SUPV.
#1 ALARM NAC	X	X	X	X	X	
#2 SUPV BELL NAC						X
#3 RELEASE SOLENOID 1	X	X		X	X	
#4 RELEASE SOLENOID 2	X	X		X	X	

Table Legend:

X = direct correlation between Input Zone and Output Circuit (input zone activation will turn on corresponding output circuit).

Input Zone Types:

- Zone 1 = 2-wire smoke
- Zone 2 = Fire
- Zone 3 = Waterflow - activation delayed for 10 seconds (Waterflow Delay set to 10 secs.)
- Zone 4 = Manual Release
- Zone 5 = Pull Station
- Zone 6 = Supervisory

Output Circuit Types:

- Output 1 = Alarm NAC, silenceable, coded for steady on
- Output 2 = Supervisory Bell NAC, silenceable, coded for steady on
- Output 3 = Release Solenoid 1 (unsupervised for shorts)
- Output 4 = Release Solenoid 2 (unsupervised for shorts)

Timers

- Soak Timer 1 - set for 10 minutes
- Soak Timer 2 - set for 10 minutes
- Waterflow Delay Timer - set for 10 seconds
- AC Loss Delay Timer - set for 2 hours

Operation

- Activation of Input Zone 1 (2-Wire Smoke) **or** Zone 2 (Fire) **or** Zone 4 (Manual Release) **or** Zone 5 (Pull Station) will operate the Alarm NAC Output #1, Release Solenoid 1 Output #3 and Release Solenoid 2 Output #4. Release Solenoid 1 will turn off water release following time-out of the 10 minute Soak Timer 1 and Release Solenoid 2 will turn off water release following time-out of the 10 minute Soak Timer 2
- Activation of Input Zone 3 (Waterflow) will operate the Alarm NAC Output #1. There is a 10 second FACP initiated delay in activation since Waterflow Delay Timer is set to 10 seconds
- Activation of Input Zone 6 (Supervisory) will operate the Supervisory Bell NAC Output #2

FACP Relay Operation

The following description of FACP relay operations are in addition to normal system operation.

- Alarm Relay - activation of Input Zone 1 (2-Wire Smoke) or Zone 2 (Fire) or Zone 3 (Waterflow - with Waterflow Delay time) or Zone 4 (Manual Release) or Zone 5 (Pull Station) will operate Alarm Relay
- Trouble Relay - any system trouble will activate the Trouble Relay
- Supervisory - activation of Zone 6 (Supervisory) will operate the Supervisory Relay

Device Installation Example for Template 3

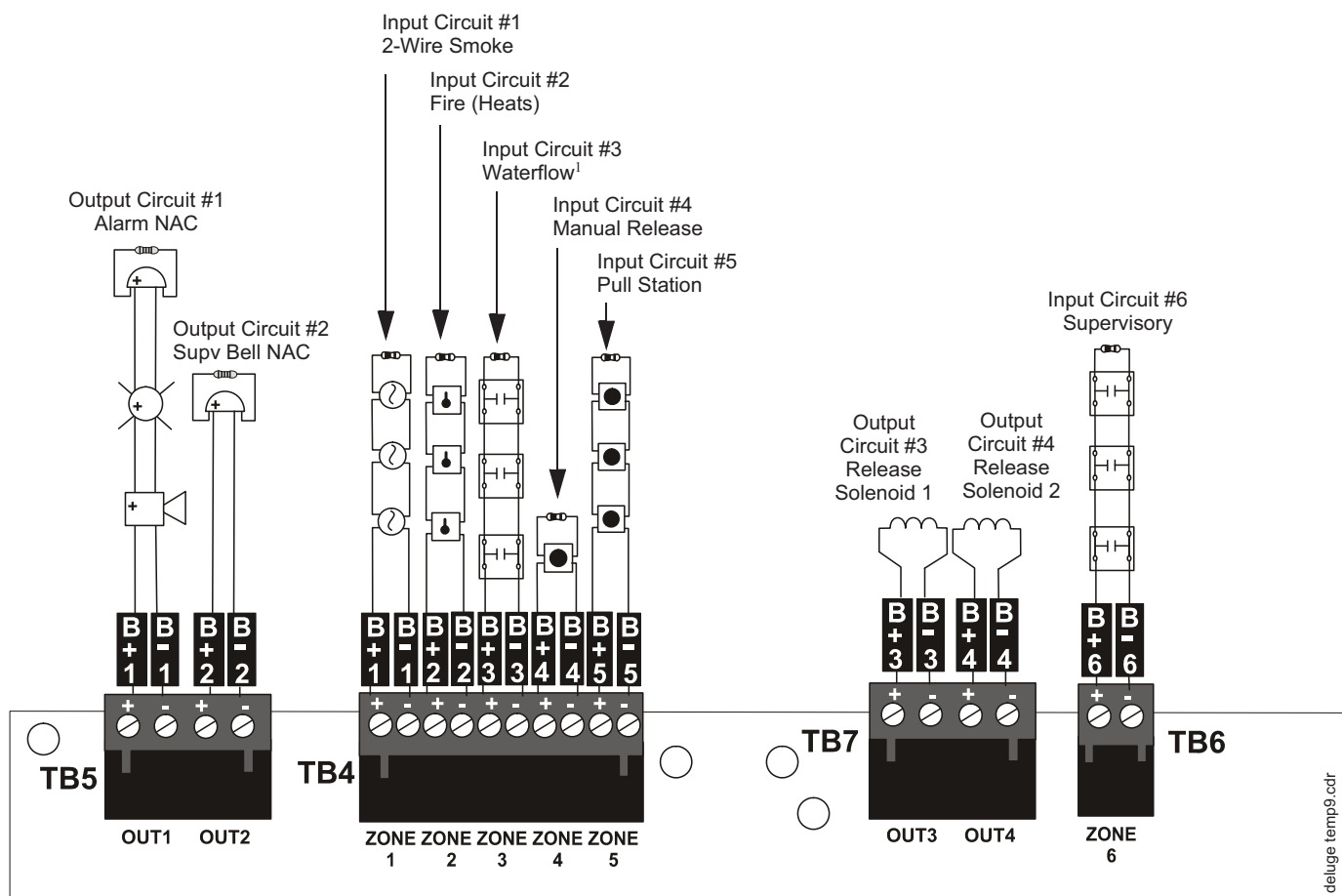

Notes:

1. Waterflow Delay is programmed for 10 seconds.
2. All End-of-Line Resistors, illustrated in this example, are 4.7KΩ, 1/2 watt (PN: 71252).
3. All devices are connected as Class B circuits. For details on connecting as Class A circuits, refer to “N-CAC-5X Class A Converter Module” on page 27.

B.4 Template 4: Dual Hazard - Split Release

Template 4: DUAL HAZARD - SPLIT RELEASE

	INPUT ZONES					
	1	2	3	4	5	6
OUTPUT CIRCUITS	2-WIRE SMOKE	FIRE	WATERFLOW	SUPV.	MANUAL RELEASE	PULL STATION
#1 ALARM NAC	X	X	X		X	X
#2 SUPV BELL NAC				X		
#3 RELEASE SOLENOID 1	X				X	X
#4 RELEASE SOLENOID 2		X			X	X

Table Legend:

X = direct correlation between Input Zone and Output Circuit (input zone activation will turn on corresponding output circuit).

Input Zone Types:

- Zone 1 = 2-wire smoke
- Zone 2 = Fire
- Zone 3 = Waterflow - activation delayed for 10 seconds (Waterflow Delay Timer 10 set to secs.)
- Zone 4 = Supervisory
- Zone 5 = Manual Release
- Zone 6 = Pull Station

Output Circuit Types:

- Output 1 = Alarm NAC, silenceable, coded for steady on
- Output 2 = Supervisory Bell NAC, silenceable, coded for steady on
- Output 3 = Release Solenoid 1 (unsupervised for shorts)
- Output 4 = Release Solenoid 2 (unsupervised for shorts)

Timers

- Soak Timer 1 - set for 10 minutes
- Soak Timer 2 - set for 10 minutes
- Waterflow Delay Timer - set for 10 seconds
- AC Loss Delay Timer - set for 2 hours

Operation

- Activation of Input Zone 1 (2-Wire Smoke) will operate Release Solenoid 1 Output #3 and Alarm NAC Output #1. Activation of Input Zone 2 (Fire) will operate Release Solenoid 2 Output #4 and Alarm NAC Output #1. Activation of Input 5 (Manual Release) **or** Input 6 (Manual Pull Station) will operate Solenoid 1 Output #3 **and** Solenoid 2 (Output #4) **and** Alarm NAC Output #1. Release Solenoid 1 will turn off water release following time-out of the 10 minute Soak Timer 1 and Release Solenoid 2 will turn off water release following time-out of the 10 minute Soak Timer 2
- Activation of Input Zone 3 (Waterflow) will operate the Alarm NAC Output #1. There is a 10 second FACP initiated delay in activation since Waterflow Delay Timer is set to 10 seconds
- Activation of Input Zone 4 (Supervisory) will operate the Supervisory Bell NAC Output #2

FACP Relay Operation

The following description of FACP relay operations are in addition to normal system operation.

- Alarm Relay - activation of Input Zone 1 (2-Wire Smoke) or Zone 2 (Fire) or Zone 3 (Waterflow - with Waterflow Delay time) or Zone 5 (Manual Release) or Zone 6 (Pull Station) will operate Alarm Relay
- Trouble Relay - any system trouble will activate the Trouble Relay
- Supervisory - activation of Zone 4 (Supervisory) will operate the Supervisory Relay

Device Installation Example for Template 4

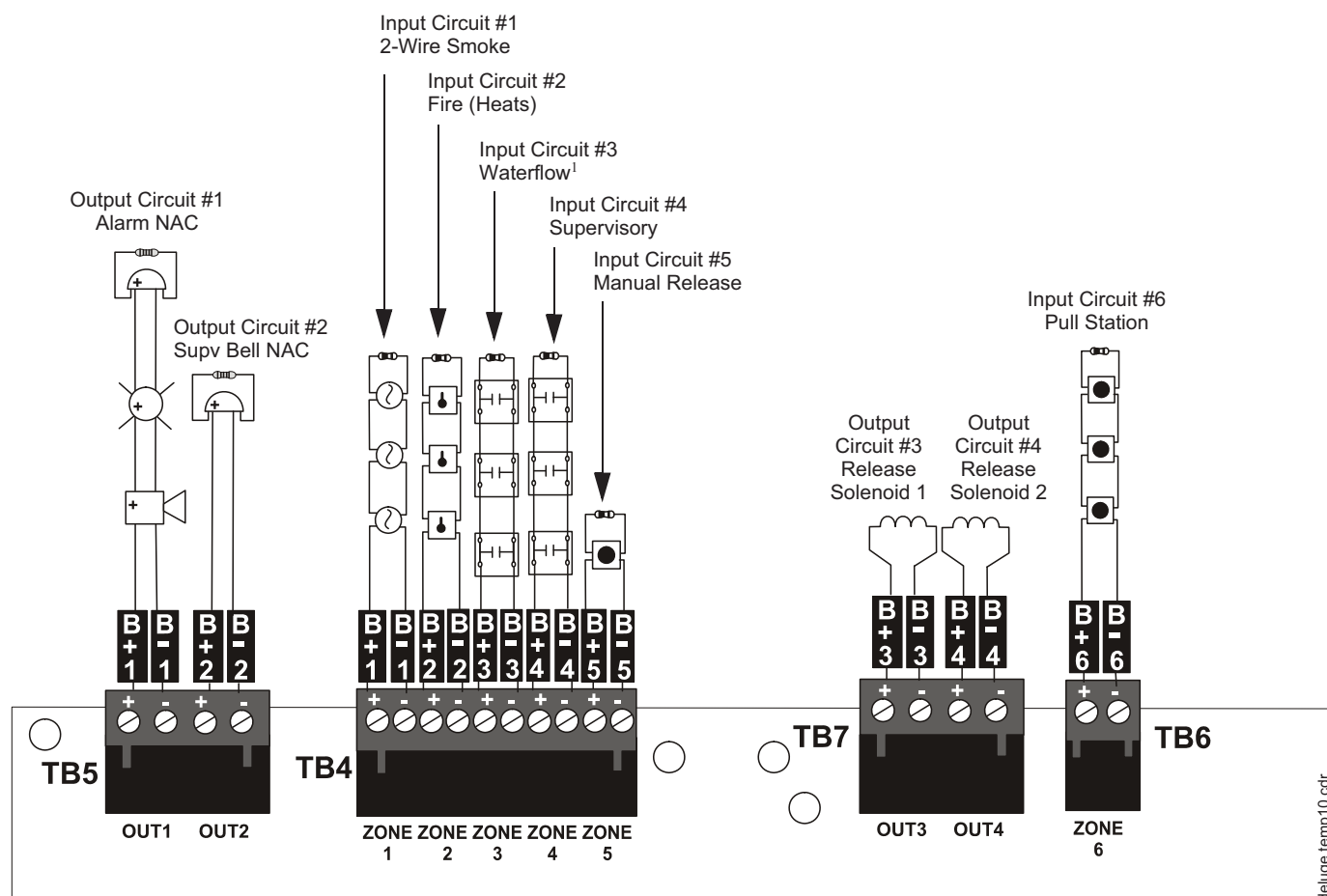

Notes:

1. Waterflow Delay is programmed for 10 seconds.
2. All End-of-Line Resistors, illustrated in this example, are 4.7K Ω , 1/2 watt (PN: 71252).
3. All devices are connected as Class B circuits. For details on connecting as Class A circuits, refer to “N-CAC-5X Class A Converter Module” on page 27.

B.5 Template 5: Single Hazard - 3 Zones and Low Pressure

Template 5: SINGLE HAZARD - 3 ZONES AND LOW PRESSURE

	INPUT ZONES					
	1	2	3	4	5	6
OUTPUT CIRCUITS	2-WIRE SMOKE	FIRE	WATERFLOW	MANUAL RELEASE	PULL STATION	LOW PRESS.
#1 ALARM NAC	X	X		X	X	
#2 WATERFLOW NAC			X			
#3 SUPV. BELL NAC						X
#4 RELEASE SOLENOID 1	X	X		X	X	

Table Legend:

X = direct correlation between Input Zone and Output Circuit (input zone activation will turn on corresponding output circuit).

Input Zone Types:

- Zone 1 = 2-wire smoke
- Zone 2 = Fire
- Zone 3 = Waterflow - activation delayed for 10 seconds (Waterflow Delay set to 10 secs.)
- Zone 4 = Manual Release
- Zone 5 = Pull Station
- Zone 6 = Low Pressure

Output Circuit Types:

- Output 1 = Alarm NAC, silenceable, coded for steady on
- Output 2 = Waterflow NAC - activation delayed for 10 secs. (Waterflow Delay set to 10 secs.), silenceable, coded for steady on
- Output 3 = Supervisory Bell NAC, silenceable, coded for steady on
- Output 4 = Release Solenoid 1 (unsupervised for shorts)

Timers

- Soak Timer 1 - set for 10 minutes
- Soak Timer 2 - set for 10 minutes
- Waterflow Delay Timer - set for 10 seconds
- AC Loss Delay Timer - set for 2 hours

Operation

- Activation of Input Zone 1 (2-Wire Smoke) **or** Zone 2 (Fire) **or** Zone 4 (Manual Release) **or** Zone 5 (Pull Station) will operate the Alarm NAC Output #1 and Release Solenoid 1 Output #4. Release Solenoid 1 will turn off water release following time-out of the 10 minute Soak Timer 1
- Activation of Input Zone 3 (Waterflow) will operate the Waterflow NAC Output #2. There is a 10 second FACP initiated delay in activation since Waterflow Delay Timer is set to 10 seconds
- Activation of Input Zone 6 (Low Pressure) will operate the Supervisory Bell NAC Output #3

FACP Relay Operation

The following description of FACP relay operations are in addition to normal system operation.

- Alarm Relay - activation of Input Zone 1 (2-Wire Smoke) or Zone 2 (Fire) or Zone 3 (Waterflow - with Waterflow Delay time) or Zone 4 (Manual Release) or Zone 5 (Pull Station) will operate Alarm Relay
- Trouble Relay - any system trouble will activate the Trouble Relay
- Supervisory - activation of Zone 6 (Supervisory) will operate the Supervisory Relay

Device Installation Example for Template 5

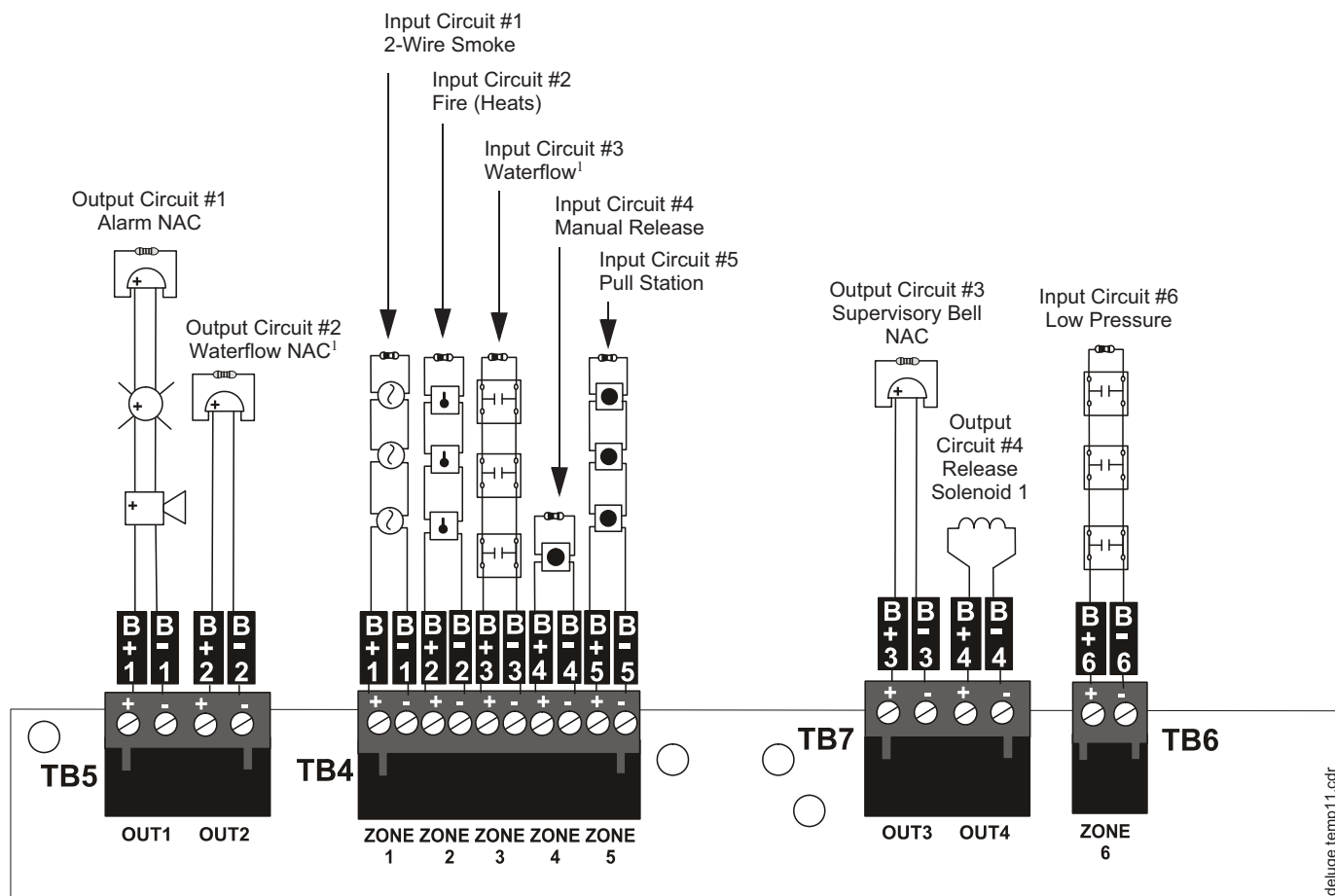

Notes:

1. Waterflow Delay is programmed for 10 seconds.
2. All End-of-Line Resistors, illustrated in this example, are 4.7K Ω , 1/2 watt (PN: 71252).
3. All devices are connected as Class B circuits. For details on connecting as Class A circuits, refer to "N-CAC-5X Class A Converter Module" on page 27.

deluge.temp11.cdr

B.6 Template 6: Single Hazard - 2 Zones Cross-Zoned With All Active

Template 6: SINGLE HAZARD - 2 ZONES CROSS-ZONES WITH ALL ACTIVE

	INPUT ZONES					
	1	2	3	4	5	6
OUTPUT CIRCUITS	2-WIRE SMOKE	FIRE	WATERFLOW	MANUAL RELEASE	PULL STATION	LOW PRESS.
#1 ALARM NAC	X	X		X	X	
#2 WATERFLOW NAC			X			
#3 SUPV. BELL NAC						X
#4 RELEASE SOLENOID 1	C1	C1		X	X	

Table Legend:

X = direct correlation between Input Zone and Output Circuit (input zone activation will turn on corresponding output circuit).

Cx = cross-zone where x is the number of the Release Solenoid. All inputs with the same Release Solenoid number must be active at the same time to turn on the corresponding solenoid output circuit

Input Zone Types:

- Zone 1 = 2-wire smoke
- Zone 2 = Fire
- Zone 3 = Waterflow - activation delayed for 10 seconds (Waterflow Delay set to 10 secs.)
- Zone 4 = Manual Release
- Zone 5 = Pull Station
- Zone 6 = Low Pressure

Output Circuit Types:

- Output 1 = Alarm NAC, silenceable, coded for steady on
- Output 2 = Waterflow NAC - activation delayed for 10 seconds (Waterflow Delay set to 10 secs.), silenceable, coded for steady on
- Output 3 = Supervisory Bell NAC, silenceable, coded for steady on
- Output 4 = Release Solenoid 1 (unsupervised for shorts)

Timers

- Soak Timer 1 - set for 10 minutes
- Soak Timer 2 - set for 10 minutes
- Waterflow Delay Timer - set for 10 seconds
- AC Loss Delay Timer - set for 2 hours

Operation

- Activation of both Input Zone 1 (2-Wire Smoke) **and** Zone 2 (Fire) at the same time, **or** Zone 4 (Manual Release) **or** Zone 5 (Pull Station) will operate the Release Solenoid 1 Output #4. Release Solenoid will turn off water release following time-out of the 10 minute Soak Timer 1. Activation of any one of these zones will operate Alarm NAC Output #1
- Activation of Input Zone 3 (Waterflow) will operate the Waterflow NAC Output #2. There is a 10 second FACP initiated delay in activation since Waterflow Delay Timer is set to 10 seconds
- Activation of Input Zone 6 (Low Pressure) will operate the Supervisory Bell NAC Output #3

FACP Relay Operation

The following description of FACP relay operations are in addition to normal system operation.

- Alarm Relay - activation of Input Zone 1 (2-Wire Smoke) or Zone 2 (Fire) or Zone 3 (Waterflow - with Waterflow Delay time) or Zone 4 (Manual Release) or Zone 5 (Pull Station) will operate Alarm Relay
- Trouble Relay - any system trouble will activate the Trouble Relay
- Supervisory - activation of Zone 6 (Supervisory) will operate the Supervisory Relay

Device Installation Example for Template 6

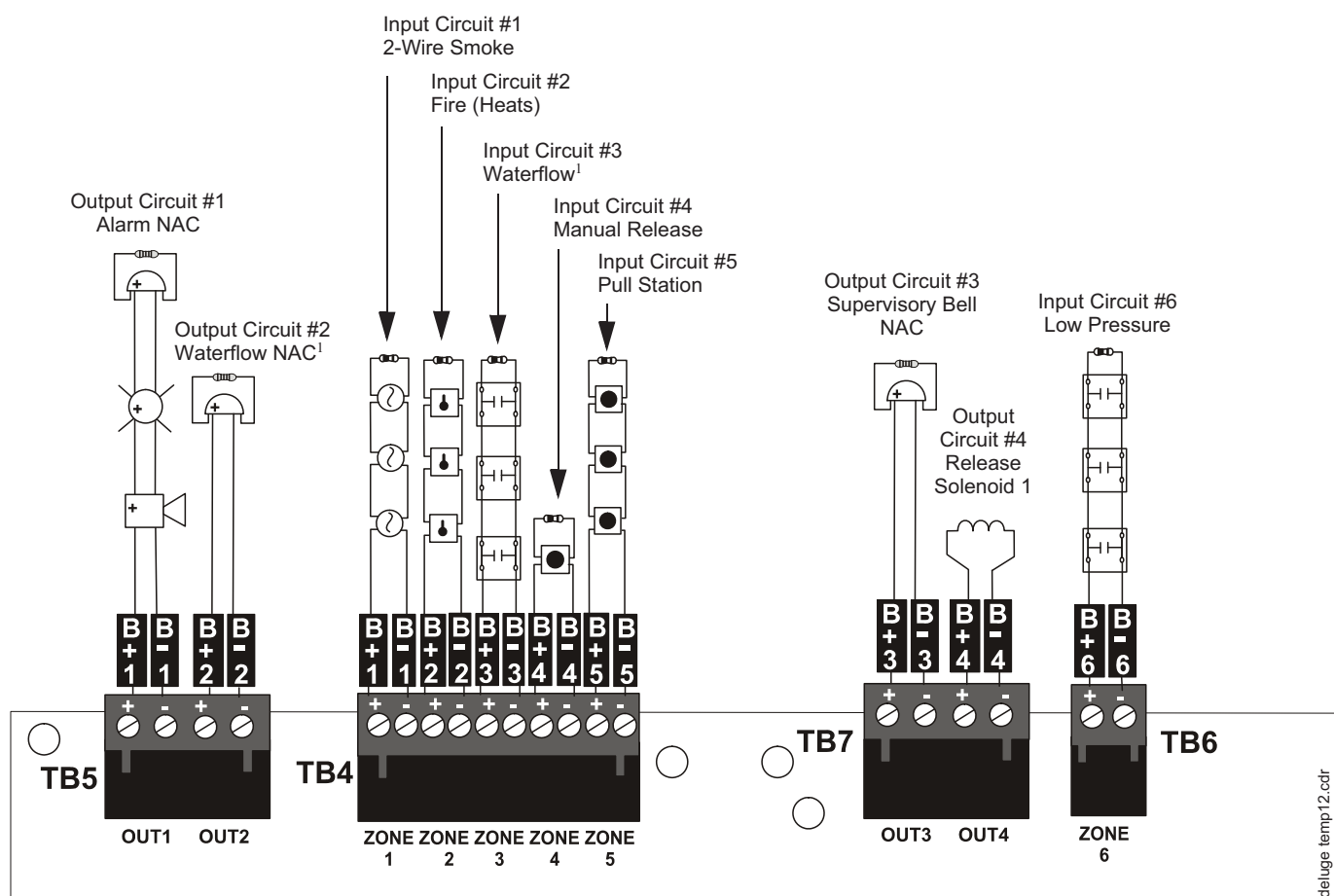

Notes:

1. Waterflow Delay is programmed for 10 seconds.
2. All End-of-Line Resistors, illustrated in this example, are 4.7K Ω , " watt (PN: 71252).
3. All devices are connected as Class B circuits. For details on connecting as Class A circuits, refer to "N-CAC-5X Class A Converter Module" on page 27.

B.7 Template 7: Single Hazard - Dual Zone

Template 7: SINGLE HAZARD - DUAL ZONE

	INPUT ZONES					
	1	2	3	4	5	6
OUTPUT CIRCUITS	2-WIRE SMOKE	FIRE	LOW PRESS.	WATERFLOW	PULL STATION	MANUAL RELEASE
#1 ALARM NAC	X	X		X	X	X
#2 WATERFLOW NAC				X		
#3 RELEASE SOLENOID 1	X	X			X	X
#4 WATERFLOW NAC				X		

Table Legend:

X = direct correlation between Input Zone and Output Circuit (input zone activation will turn on corresponding output circuit).

Input Zone Types:

- Zone 1 = 2-wire smoke
- Zone 2 = Fire
- Zone 3 = Low Pressure
- Zone 4 = Waterflow - activation delayed for 10 seconds (Waterflow Delay set to 10 secs.)
- Zone 5 = Pull Station
- Zone 6 = Manual Release

Output Circuit Types:

- Output 1 = Alarm NAC, silenceable, coded for steady on
- Output 2 = Waterflow NAC - activation delayed for 10 seconds (Waterflow Delay set to 10 secs.), silenceable, coded for steady on
- Output 3 = Release Solenoid 1 (unsupervised for shorts)
- Output 4 = Waterflow NAC - activation delayed for 10 seconds (Waterflow Delay set to 10 secs.), silenceable, coded for steady on

Timers

- Soak Timer 1 - set for 10 minutes
- Soak Timer 2 - set for 10 minutes
- Waterflow Delay Timer - set for 10 seconds
- AC Loss Delay Timer - set for 2 hours

Operation

- Activation of Input Zone 1 (2-Wire Smoke) **or** Zone 2 (Fire) **or** Zone 5 (Pull Station) **or** Zone 6 (Manual Release) will operate the Alarm NAC Output #1 and Release Solenoid 1 Output #3. Release Solenoid will turn off water release following time-out of the 10 minute Soak Timer 1
- Activation of Input Zone 4 (Waterflow) will operate the Alarm NAC Output #1, Waterflow NAC Output #2 and Waterflow NAC Output #4. There is a 10 second FACP initiated delay in activation of these outputs since the Waterflow Delay Timer is set to 10 seconds
- Activation of Input Zone 3 (Low Pressure) will not operate any Output Circuits (see Relays)

FACP Relay Operation

The following description of FACP relay operations are in addition to normal system operation.

- Alarm Relay - activation of Input Zone 1 (2-Wire Smoke) or Zone 2 (Fire) or Zone 3 (Waterflow - with Waterflow Delay time) or Zone 4 (Manual Release) or Zone 5 (Pull Station) will operate Alarm Relay
- Trouble Relay - any system trouble will activate the Trouble Relay
- Supervisory - activation of Zone 3 (Low Pressure) will operate the Supervisory Relay

Device Installation Example for Template 7

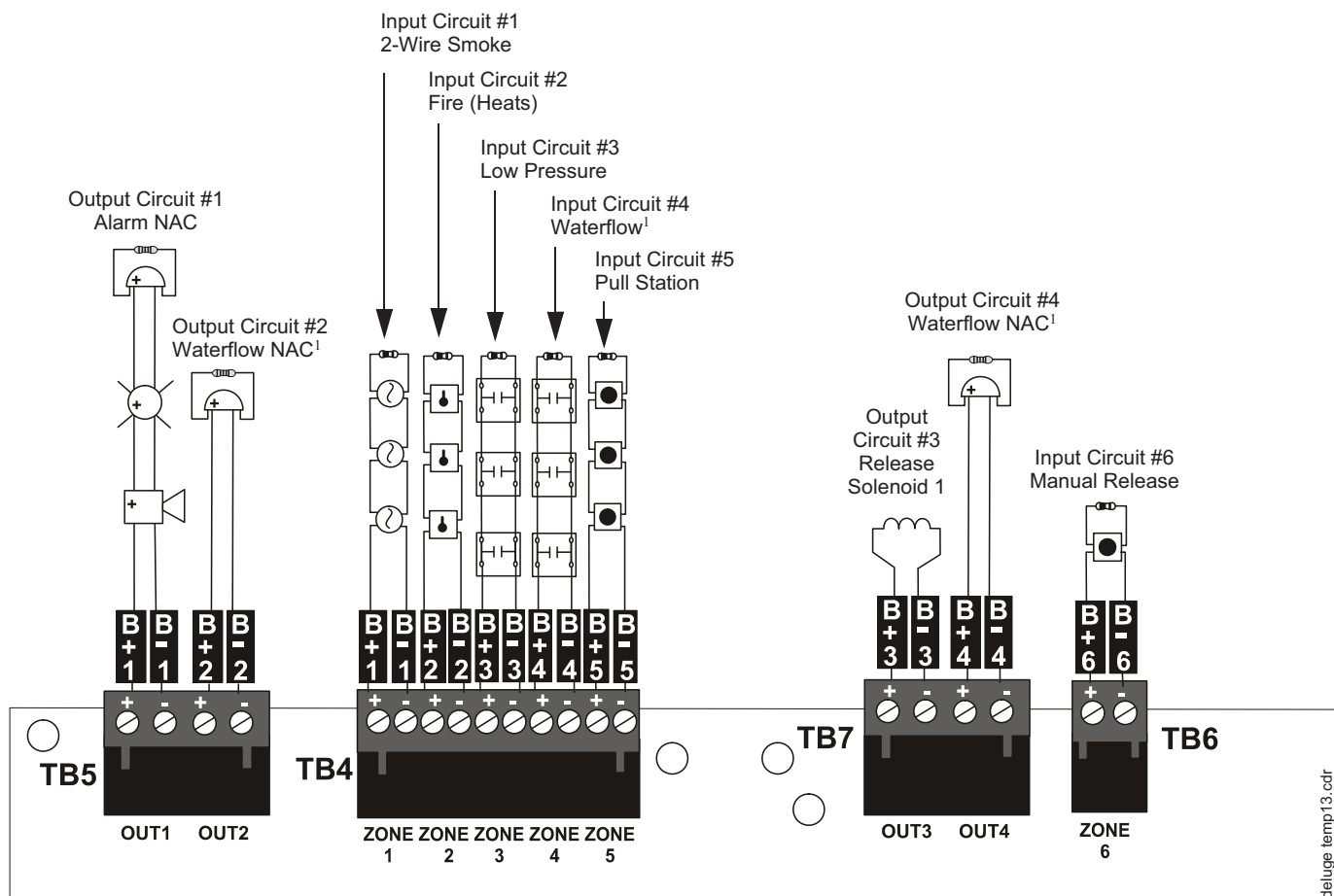

Notes:

1. Waterflow Delay is programmed for 10 seconds.
2. All End-of-Line Resistors, illustrated in this example, are 4.7KΩ, 1/2 watt (PN: 71252).
3. All devices are connected as Class B circuits. For details on connecting as Class A circuits, refer to "N-CAC-5X Class A Converter Module" on page 27.

Appendix C: NFPA Standard-Specific Requirements

This panel has been designed for use in commercial, industrial and institutional applications and meets the requirements for service under the National Fire Protection Association (NFPA) Standards outlined in this Appendix. The minimum system components required for compliance with the appropriate NFPA standard are listed below:

RP-2001 Control Panel

Contains the main control board, cabinet (backbox and door) and power supply.

Batteries

Refer to “Power Supply Calculations” on page 98, for Standby Power Requirements.

Initiating Devices

Connected to one of the control panel's Initiating Device Circuits.

Notification Appliances

Connected to one of the control panel's Output Circuits.

Releasing Devices

Connected to one of the control panel's Output Circuits.

The following additional equipment is needed for compliance with the NFPA 72 standards listed below:

NFPA 72 Central Station Service (Protected Premises Unit) or Remote Station Service

411UD may be installed as illustrated in Figure C.1, “FACP Connection to 411UD,” on page 123

OR

4XTM Transmitter Module for connection to the RS82 Remote Station Receiver. See Figure C.3 on page 126, for installation instructions for this unit

NFPA 72 Auxiliary Fire Alarm System

4XTM Transmitter Module for connection to a compatible listed Local Energy Municipal Box. This unit must be installed as illustrated in the section titled “4XTM Municipal Box Transmitter Option Module” on page 29 and as outlined in Figure C.2, “Municipal Box Connected to 4XTM Transmitter Module,” on page 125.

NFPA 72 Proprietary Fire Alarm System

FACP Alarm, Trouble and Supervisory contacts connected to Transmitter(s). See Figure C.4, “Proprietary Protective Signaling System,” on page 127, for installation instructions for this unit.

The relay contacts of this control panel may be used to trip any dialer that is UL-listed for Central Station/Remote Station services. The illustrations in this appendix provide examples of possible system configurations.

The following figure illustrates an example of Central Station/Remote Station Reporting using a 411UD. The relay contacts from the RP-2001 may be used to trip any dialer UL-listed for Central Station/Remote Station Reporting Services.

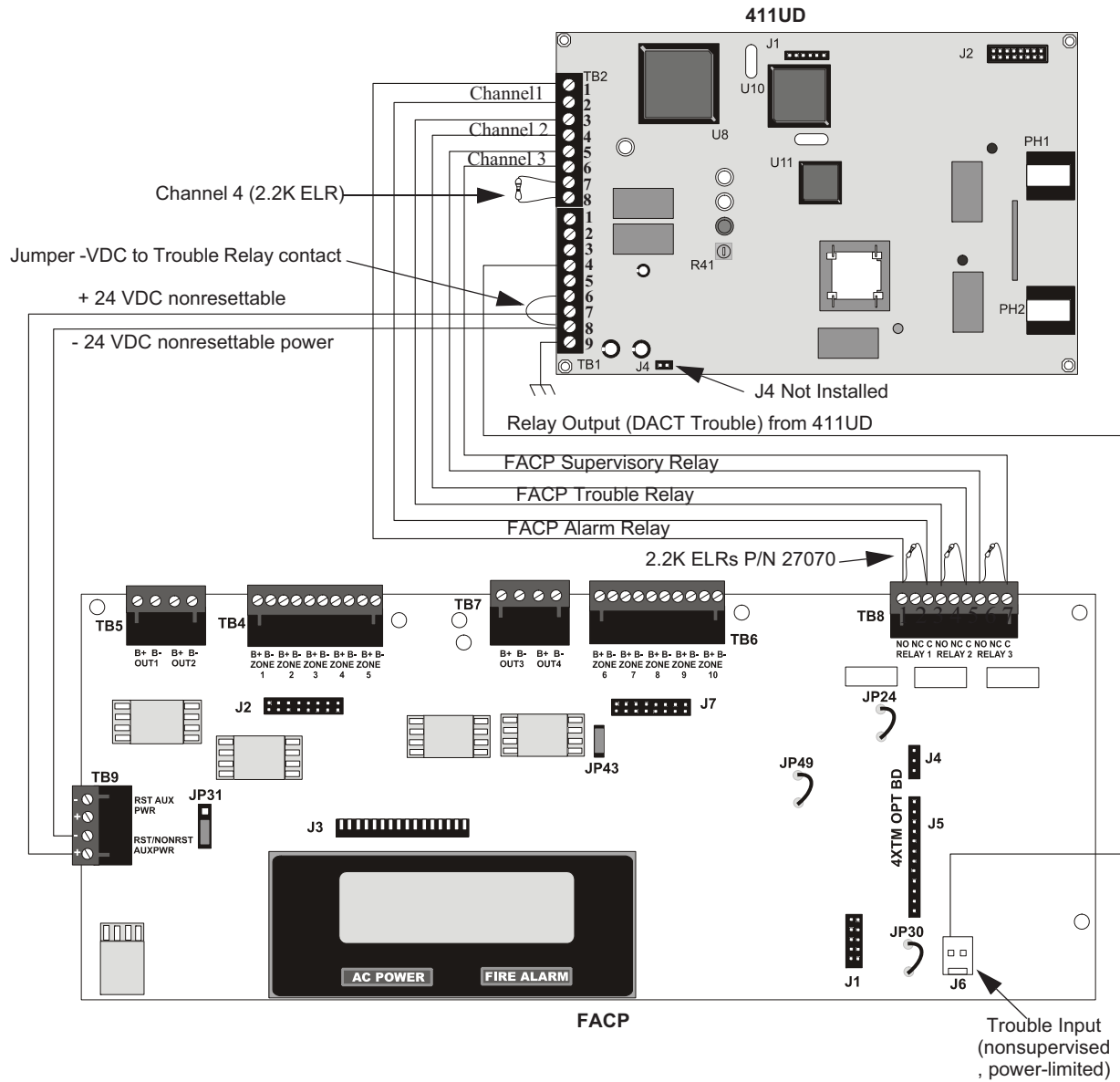

Figure C.1 FACP Connection to 411UD

	411UD	FACP
Alarm	TB2-1	TB8-1
	TB2-2	TB8-3
Trouble	TB2-3	TB8-4
	TB2-4	TB8-6
Supervisory	TB2-5	TB8-7
	TB2-6	TB8-9

Table C.1 411UD Connections to FACP

Notes:

1. Reference the 411UD Manual for additional information
2. All connections between the control panel and the 411UD must be in conduit, less than 20 ft. (610 cm) in length in the same room.
3. Any zone of the 411UD can be wired to function as alarm, trouble or supervisory; the 411UD must be programmed accordingly. In this example, Channel/Zone 1 is wired to the control panel's alarm relay, Channel 2/Zone 2 is wired to the control panel's trouble relay and Channel 3/Zone 3 is wired to the control panel's supervisory relay.
4. Nonresettable 24 VDC power is supplied to the 411UD via TB9 terminals configured for nonresettable power on the FACP. Jumper J4 on the 411UD must be removed for 24 VDC power.
5. End-of-Line resistors must terminate all 411UD circuits, including unused circuits.
6. Program the 411UD for slave operation.
7. The RP-2001 must be programmed for AC Loss Reporting Delay. This prevents the immediate transmission of a trouble on the loss of AC power.
8. A (-)VDC from the 411UD Trouble Contacts will activate the Trouble Input J6 on the FACP when the 411UD goes into DACT Trouble (the 411UD Trouble Contact is programmed as DACT Trouble).

C.1 NFPA 72 Auxiliary Fire Alarm System

All connections are power-limited and supervised. This application is not suitable for separate transmission of sprinkler supervisory or trouble conditions.

Notes:

1. 3 ohms maximum loop resistance allowed for wiring from control panel to Municipal Box.
2. Cut JP30 on the RP-2001 main circuit board to supervise placement of 4XTM module and circuit.
3. Cut JP24 on the RP-2001 main circuit board to enable FACP Supervisory relay.
4. Refer to “4XTM Municipal Box Transmitter Option Module” on page 29 for detailed information.

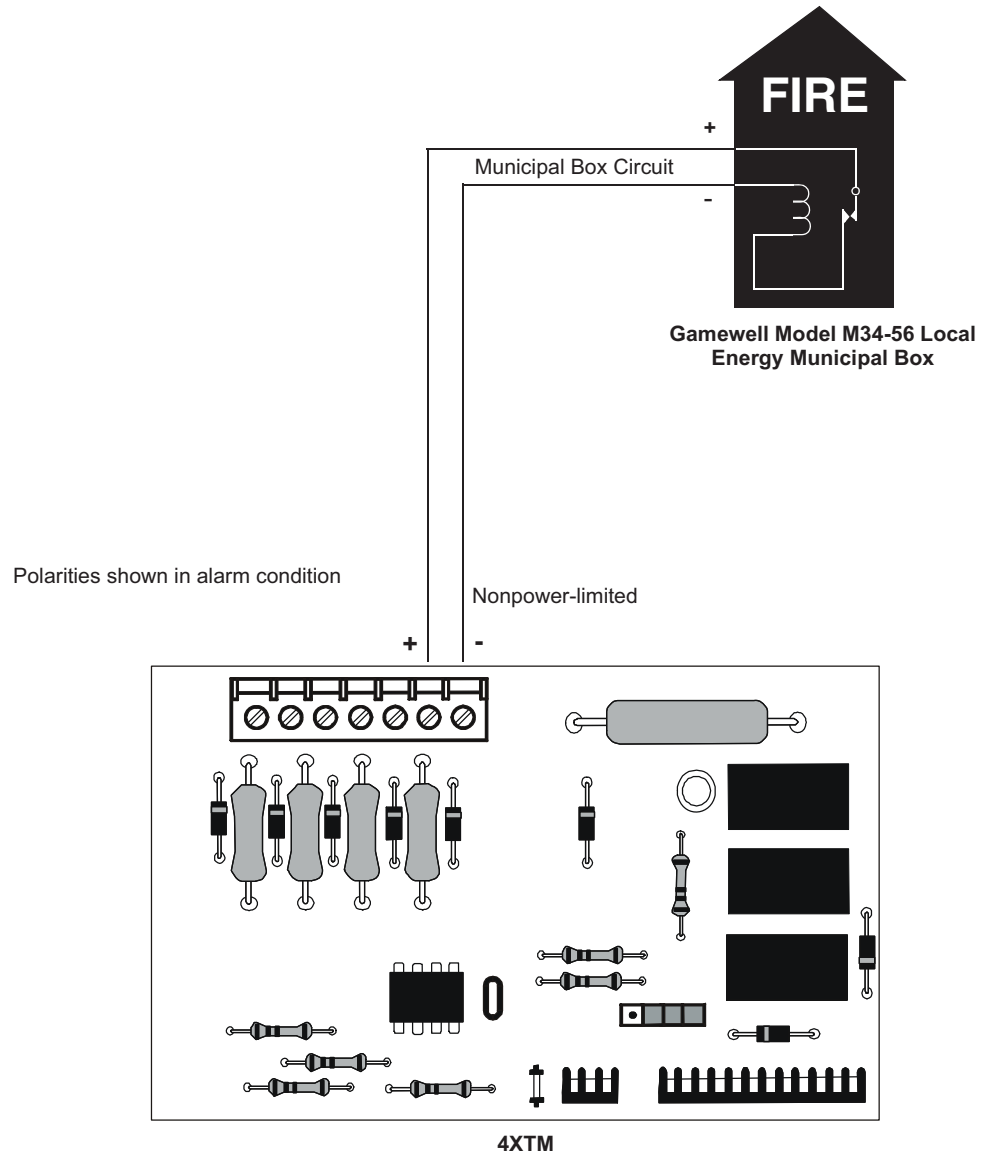

Figure C.2 Municipal Box Connected to 4XTM Transmitter Module

NFPA 72 Remote Station Protective Signaling System

Notes:

1. Cut Jumper JP30 on the RP-2001 main circuit board to supervise placement of the 4XTM module.
2. Refer to “4XTM Transmitter Module Installation” on page 29 for detailed information.

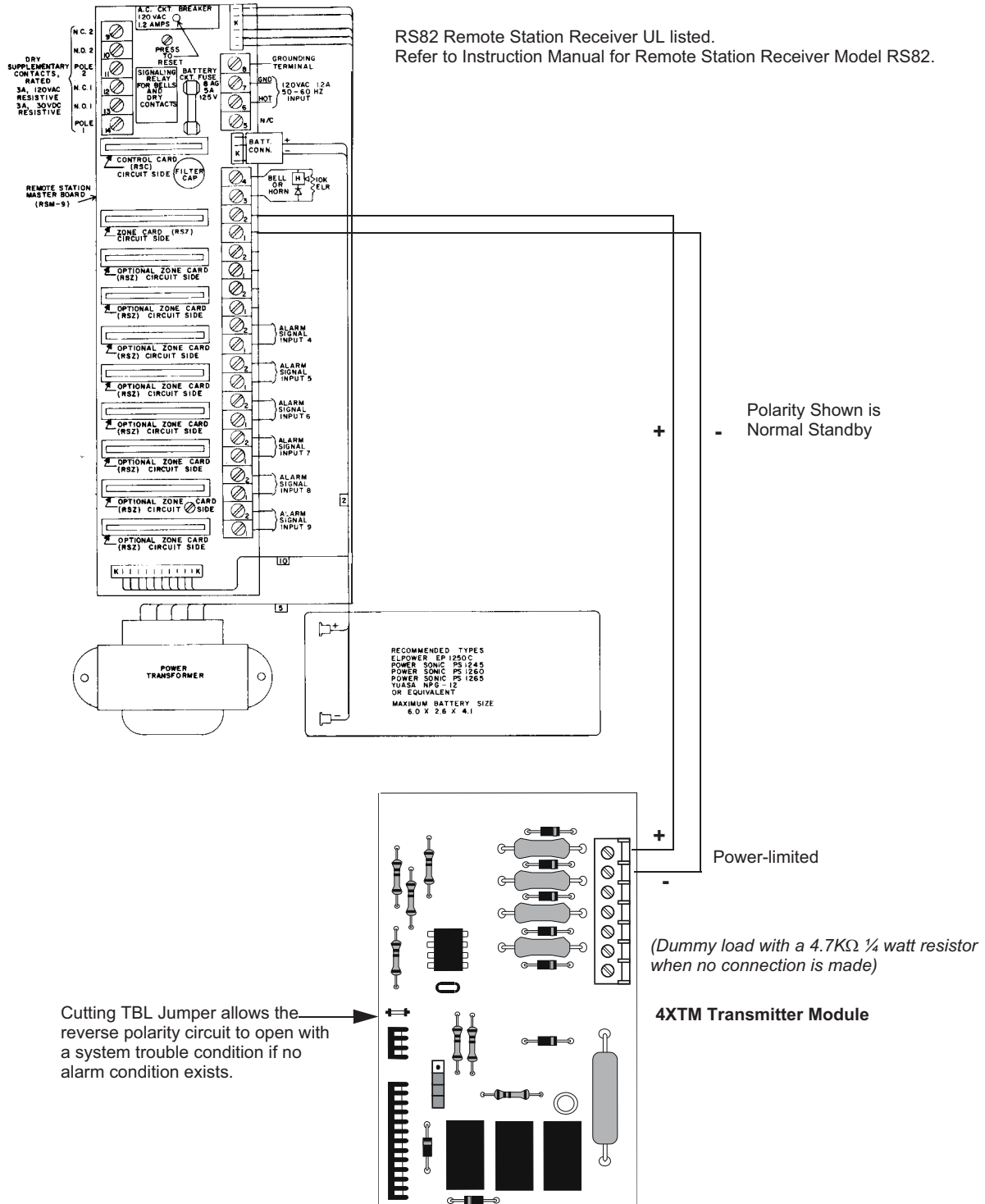

Figure C.3 Remote Station Connection Using 4XTM Module

NFPA 72 Proprietary Protective Signaling Systems

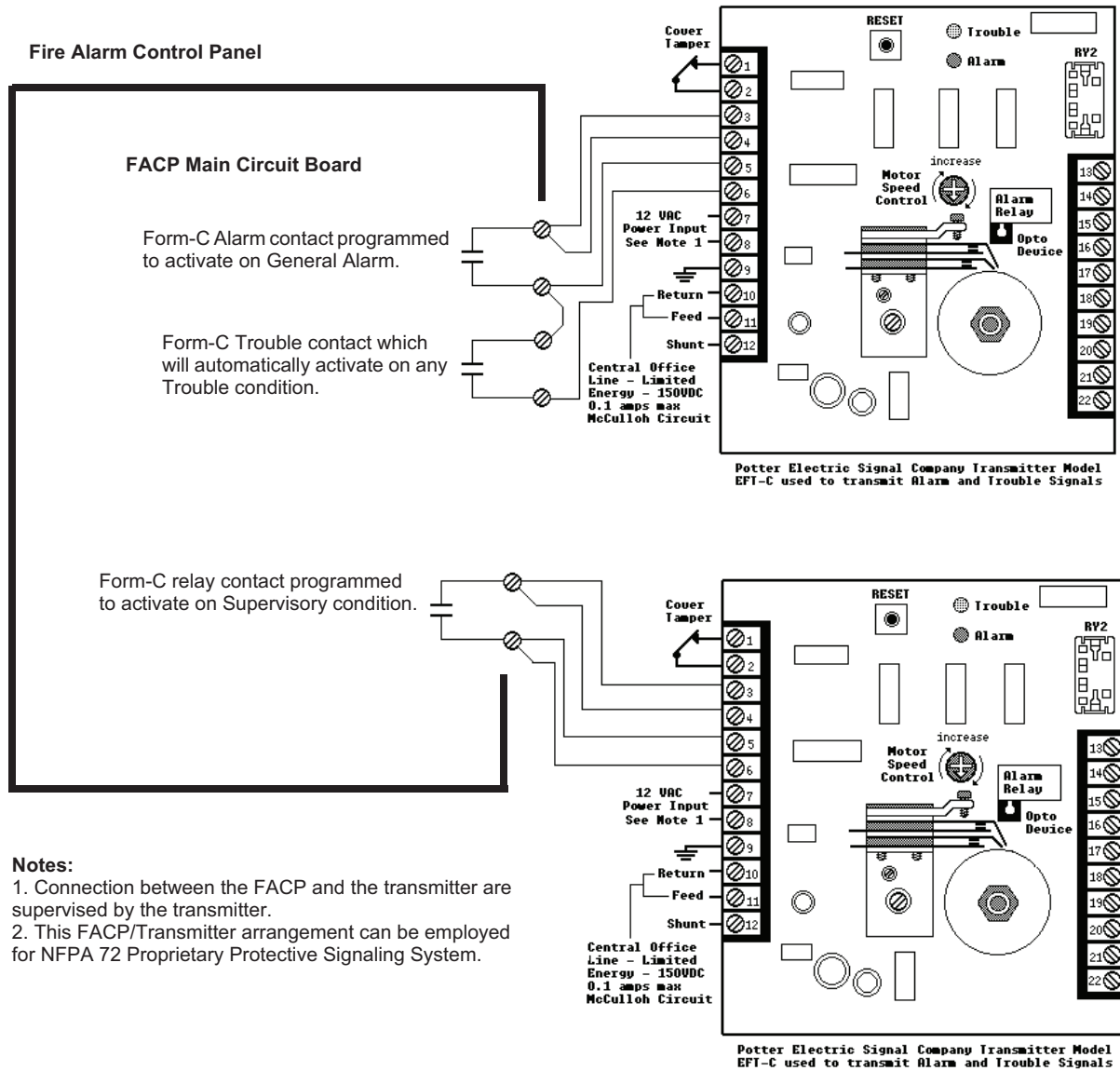
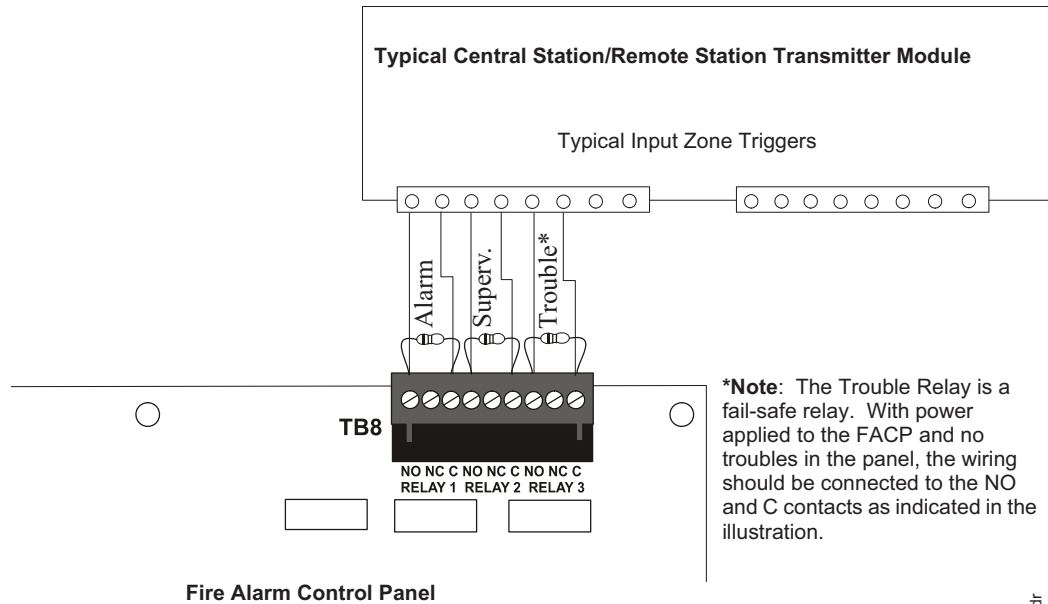

Figure C.4 Proprietary Protective Signaling System

C.2 Central Station/Remote Station Transmitter: Connection to FACP Dry Contacts

The dry contacts of the RP-2001 programmable relays can be used to trip a UL-864 Listed Central Station/Remote Station Transmitter. The FACP contacts must be supervised by the Central Station/Remote Station Transmitter module using End-of-Line Resistors (ELRs) with a value determined by the Transmitter manufacturer. Power is also provided by the Central Station/Remote Station Transmitter manufacturer. Refer to the Central Station/Remote Station Transmitter manufacturer’s manual for details.



rp2002drysmitt.cdr

Figure C.5 FACP Dry Contacts Connection to Central Station/Remote Station Transmitter

Appendix D: FACP with Keltron

The following figure illustrates the connections between the FACP and Keltron Receiver/Transmitter.



CAUTION: OBSERVE CORRECT TERMINAL LOCATIONS

FOR REASONS OF WIRING DIAGRAM CLARITY, TERMINAL DESIGNATIONS OF KELTRON MODULES ARE NOT SHOWN IN ACTUAL ORDER. FOLLOW KELTRON MANUAL AND MODULE MARKINGS FOR EXACT TERMINAL LOCATIONS TO PREVENT SEVERE MODULE DAMAGE.

IMPORTANT! All connections between the FACP and Keltron modules must be made within 20 feet and enclosed within conduit or equivalently protected against mechanical injury.

Keltron 95M3158 TTM-RPS

1. Terminals 7 and 8: Remote station alarm/trouble inputs.
2. Terminals 9 and 10: Sprinkler supervisory input.

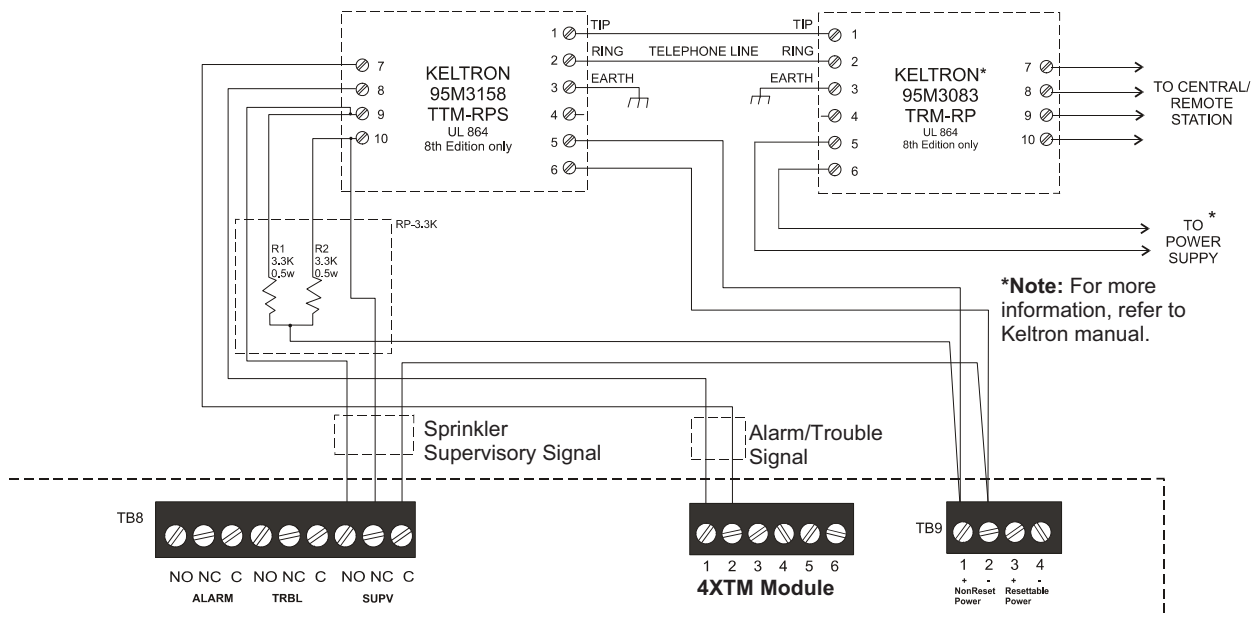

Note: Cut TBL jumper on 4XTM module to send alarm/trouble signal from the same pair or terminals.

Fire Alarm Control Panel

(terminal blocks are not shown in their actual positions in order to clarify wiring connections)

Appendix E: Testing & Maintenance

E.1 Testing

E.1.1 Inspection

Once installation has been completed, a careful visual inspection should be made before applying power to the system. Check the actual wiring hookup with the wiring diagrams. Insure that no pieces of wire have fallen into the circuitry. Check for missing or damaged parts.

E.1.2 Alarm Test

An initial alarm test should be conducted following installation to determine that all parts of the system are functioning properly. The panels should remain powered for 24 to 36 hours prior to connecting the releasing solenoids. This precaution will avoid false activation of the suppression system in case of faulty or improperly placed detectors.

To perform an alarm test on the control panel, proceed with the following steps:

1. Disconnect AC power and battery power.
2. Disconnect the installed solenoid valve circuit leads and connect spare solenoid valves or connect an End-of-Line device to serve as a dummy load.
3. Reconnect AC and battery power.
4. Initiate a first zone alarm condition by introducing smoke into one of the Zone 1 detectors. This should cause the first zone alarm condition.
 - ✓ The red Fire Alarm indicator will illuminate
 - ✓ The LCD display will indicate an alarm condition for zone 1
 - ✓ The control panel piezo will sound
 - ✓ The Alarm relay will energize
 - ✓ The devices connected to the Indicating Circuit(s) programmed to activate on Zone 1 alarm will turn on
5. Repeat step 4 for each input zone.
6. When testing has been completed, remove AC and battery power, reconnect the solenoid valve circuits removed in step 2, reconnect AC and battery power and ensure that the control panel is in normal standby condition.

E.1.3 Detector Testing

Detectors must be tested after installation and following maintenance.

Important: Before testing, notify the proper authorities that maintenance is being performed and the system will be temporarily out of service. Disable the zone or system undergoing maintenance to prevent any unwanted alarms. Disconnect the installed solenoid valve circuit leads and connect spare solenoid valves or connect an End-of-Line device to serve as a dummy load to prevent unwanted water release.

Ensure proper wiring and power is applied. After power-up, allow 80 seconds for the detectors to stabilize before testing. Refer to System Sensor's *i³* Installation and Maintenance Instructions document I56-1800-00 for device specifications and testing procedures.

Test i³ Series detectors as follows:**Test Switch**

1. An opening for the recessed test switch is located on the detector housing.
2. Insert a small screwdriver or allen wrench (0.18" max.) into the test switch opening; push and hold.
3. If the detector is within the listed sensitivity limits, the detector's red LED should light within five seconds.

Smoke Entry Test

Hold a smoldering punk stick or cotton wick at the side of the detector and gently blow the smoke through the detector until it alarms.



NOTE: For the above tests, the detector will reset only after the power source has been momentarily interrupted.

If a detector fails any of the above test methods, its wiring should be checked and it should be cleaned as outlined in the Maintenance section of the System Sensor Document. If the detector still fails, it should be replaced.

Notify the proper authorities when the system is back in service.

E.2 Maintenance

A regular schedule of inspection, testing and maintenance is vital to ensure proper and reliable operation of the control panel. The procedures should be performed as required by the local authority having jurisdiction. Refer to NFPA documentation for further details.

Appendix F: Wire Requirements

Connecting external system accessories to the main circuits must be carefully considered to ensure proper operation. It is important to use the correct type of wire, gauge and run length for each circuit. Reference the chart below to specify wire requirements and limitations for each circuit.

CIRCUIT CONNECTIONS		WIRE REQUIREMENTS		
Circuit Type	Circuit Function	Wire Type and Limitations	Recommended Max. Distance Feet (meters)	Wire Gauge
Initiating Device Circuit (power-limited)	Connects to Initiating Devices	Untwisted, unshielded wire (maximum loop resistance not to exceed 100 ohms)	Distance limitation set by 100 ohm resistance limitation	12-18 AWG (3.25 - 0.75 mm ²)
ANN-BUS (EIA-485) power-limited	Communication for ANN-BUS annunciator and relay modules	Twisted pair a maximum loop resistance of 120 ohms	6,000 (1,800 m)	12-18 AWG (3.25 - 0.75 mm ²)
ANN-BUS Power	Power for ANN-BUS annunciators	Refer to "ANN-BUS Devices" on page 31 for information on device wiring		
24 VDC Regulated, resettable, nonresettable	Power for accessories and 4-wire devices	Untwisted, unshielded wire	Distance limitation set by 4 volt maximum line drop	12-18 AWG (3.25 - 0.75 mm ²)
Auxiliary Trouble Input	Open Collector trouble input for CHG-75, CHG-120, etc.	Single conductor	Distance limitation 20 feet in same room	18 AWG (0.75 mm ²)
NAC/Solenoid Outputs	Connects to NAC devices or Release devices	Untwisted, unshielded pair wire	Refer to Section F.1 on page 133.	

Table F.1 FACP Wire Specifications

F.1 NAC Wiring

The following table lists NAC wiring requirements for the FACP.

NAC Load (Amps)	Max. allowable total loop resistance (ohms)	CLASS-B Max. allowable wire pair length (feet)				CLASS-A Max. allowable wire pair length (feet)			
		AWG 12 solid	AWG 14 solid	AWG 16 solid	AWG 18 solid	AWG 12 solid	AWG 14 solid	AWG 16 solid	AWG 18 solid
0.25	13.60	3523	2215	1391	875	1762	1107	695	438
0.5	6.80	1762	1107	695	438	881	554	348	219
0.75	4.53	1174	738	464	292	587	369	232	146
1	3.40	881	554	348	219	440	277	174	109
1.25	2.72	705	443	278	175	352	221	139	88
1.5	2.27	587	369	232	146	294	185	116	73
1.75	1.94	503	316	199	125	252	158	99	63
2	1.70	440	277	174	109	220	138	87	55
2.25	1.51	391	246	155	97	196	123	77	49
2.5	1.36	352	221	139	88	176	111	70	44
2.75	1.24	320	201	126	80	160	101	63	40
3	1.13	294	185	116	73	147	92	58	36

Table F.2 NAC Wiring Requirements for FACP

Calculations are based on Direct-Current Resistance data for uncoated copper wire, per National Electrical Code (2005 Edition) Table 8, Conductor Properties.

Index

Numerics

2nd-Shot Water Switch **51**
4XTM **126**

A

AC Loss Delay **65, 67**
AC power **20**
 rating **13**
 requirements **98**
accessories **15**
ACK
 see also Acknowledge **12**
Acknowledge **12**
Acknowledge/Step **14, 84**
Adjective
 list **53**
 multiple entries **55**
alarm **87**
 piezo pulse rate **15**
alarm relay **11, 25**
 contact rating **13**
Alarm Silenced **12, 14, 84**
ANN-80 module **35**
ANN-BUS **97**
 auto-configure **72**
 aux. power **34**
 device addressing **34**
 devices **11, 31**
 modules **71**
 wiring **31**
 wiring configuration **33**
 wiring distance **31**
 wiring distance chart **32**
ANN-I/O module **39**
 LED zone assignments **74**
ANN-LED module **42, 43**
ANN-RLY module **43**
ANN-S/PG module **37, 96**
auto-configure
 ANN-BUS **72**
Autosilence
 NAC **59**
Autosilence Timer **90**
auxiliary power **25**
Auxiliary Trouble Input **13**

B

backbox
 dimensions **15**
 mounting **17**
Banner **64**

 setting **67**
battery **15, 21**
 precautions **21**
 rating **13**
battery box **16**
battery calculations **101**
buttons
 see also control buttons **12**

C

cabinet
 dimensions **19**
 mounting **17**
cabinet mounting **20**
CAC-5X **22**
California **61**
Canadian Option **64, 70**
charger capacity **13**
charger disable **64, 70**
circuits **11**
Class A **15, 22, 28**
Class A Converter Module **15**
 installation **27**
Class B **11, 13, 22**
clear programming **79**
Clock Format **69**
Coded Operation **89**
Coding
 NAC **60**
combination circuit **23**
combination waterflow/supervisory **23**
 requirements **23**
 wiring **23**
compatibility
 see also device compatibility **11**
configuration
 programming **49**
control buttons **12, 84**
controls **14**
cross input zones **62, 94**
Cross-Zone **61**
cross-zoning **62**
current
 nonresettable power **25**
 resettable power **25**
 total output **24**
current requirements for system **99, 100**

D

Date setting **69**
Daylight Savings Time **69, 96**
Description

- detector label **54**
- Detector
 - adding description **53**
 - enable/disable **50**
 - functions **89**
- device compatibility **11**
- dimensions
 - backbox **15**
- Disable Release **45, 51**
- Disable/Enable **88**
- dress panel **12, 16**
- Drill **12, 14, 84**

E

- earth ground **20**
- edit
 - detector screens **50**
- Enable/Disable **81**
 - zone **50**
- End-of-Line resistor
 - IDC **13, 22, 23**
 - NAC **13, 24**
- Enter key **47**
- Erase History **77**
- exiting
 - programming **46, 47**
 - Read Status **46, 47**

F

- FACP configuration **49**
- fail-safe
 - trouble relay **25**
- features **11**
- Form-C
 - see also relay **11**
- freeze **22, 88**
- freeze signal
 - see also smoke detector monitoring **11**
- Freeze Supervision **52, 86, 89**

H

- History **77, 96**
 - erase **77**
 - log **11**
 - maintenance level **81**
 - view events **77**

I

- i3 detectors **22**
- IDC **11, 13, 22**
 - alarm current **13**
 - compatibility **22**
 - End-of-Line resistor **13, 22, 23**
 - maximum loop resistance **13, 22**

- short circuit current **13**
- standby current **13**
- wiring **22**
- indicator **14**
 - AC Power **12, 15, 85**
 - Alarm Silenced **12, 15, 85**
 - Discharge **12, 15**
 - discharge **85**
 - Fire Alarm **12, 15, 85**
 - Supervisory **12, 15, 85**
 - System Trouble **15**
 - Trouble **12, 85**
- Initiating Device Circuit **11, 13, 22**
 - Class A **28**
- In-Line resistor
 - IDC combination circuit **23**
- input zone types **51**
- Input Zones **49, 92**
- installation **17**
 - 4XTM **29**
 - class A converter module **27**
 - option modules **27**
 - transmitter module **29**

J

- J4 and J5
 - option module connectors **29**
- JP30 jumper
 - placement supervision **29**

K

- Key Panel **14**
 - function keys **14**
 - service/program keys **14**

L

- lamp test **14**
- LCD display **11, 14**
- LED annunciator module **16**
- LED driver module **16, 39**
 - connections **41**
 - specifications **40**
 - wiring LEDs **41**
- LED option module
 - LED zone assignments **74**

M

- Main **10**
- maintenance **22**
 - piezo pulse rate **15**
- Maintenance Alert **89**
- Maintenance Program Level 2 **46, 80**
- maintenance signal
 - see also smoke detector monitoring **11**

Manual programming **45**
 Map **52**
 March Time **61**
 Master Program Level 1 **46, 48**
 Mode key **47**
 mounting
 cabinet **17**
 main circuit board **17**
 municipal box **29**
 municipal box transmitter
 see also 4XTM **15**

N

NAC **11, 13**
 Auto Silence **59**
 coded **89**
 current **24**
 End-of-Line resistor **13, 24**
 maximum current **13**
 programmable **12**
 synchronized **61**
 wiring **24**
 NFPA 72 Auxiliary Fire Alarm System **122, 125**
 NFPA 72 Central Station Service (Protected Premises Unit) or Remote Station Service **122**
 NFPA 72 Proprietary Fire Alarm System **122**
 NFPA 72 Proprietary Protective Signaling Systems **127**
 NFPA 72 Remote Station Protective Signaling System **125**
 NFPA Standard **122**
 nonpower-limited wiring **26**
 nonresettable power **11, 14, 25**
 current **25**
 maximum current **14**
 Normal **85**
 normal display **45**
 Notification Appliance Circuit **11, 13, 24**
 Class A **28**
 Noun
 list **54**
 multiple entries **55**
 Noun/Adjective **53, 54**

O

Operating Instructions **84**
 Operation
 alarm **87**
 disable/enable **88**
 normal **85**
 supervisory **88**
 trouble **86**
 waterflow **89**
 option modules **15, 71**
 installation **27, 29**
 output

 coding **60**
 enable/disable **56**
 silence inhibit **59**
 silenceable **58**
 types **56**
 output circuits **12, 24, 55**
 map **52**

P

Password **47**
 change **79**
 Maintenance Level 2 **47, 80**
 Master Level 1 **47**
 piezo **15**
 alarm **15**
 maintenance **15**
 see also sounder **12, 14**
 supervisory **15**
 trouble **15**
 polarity reversal circuit
 see also transmitter module **30**
 power **14, 20, 25**
 primary **20**
 secondary
 see also battery **21**
 power supply calculations **98**
 power-limited wiring **26**
 Power-up
 first time **46**
 printer connection **38**
 printer module **16, 37**
 installation **38**
 specifications **38**
 printer options **39, 73**
 product description **11**
 Program
 clear **79**
 program keys
 see also Key Panel **14**
 Programming **45**
 autoprogramming **45**
 exiting **46**
 Level 1 **46**
 Level 2 **46**
 manual **45**
 Master Level 1 **48**
 Programming Levels **46**
 Programming Screens **46**

R

Read Status **45, 91**
 ANN-BUS **97**
 Configuration **92**
 Cross Input Zones **94**
 exiting **46**
 history **96**

- Input Zones **92**
- input zones **92**
- NAC **93**
- Output Circuits **93**
- Print **96**
- relay **94**
- Real-Time Clock **89**
- Recall/Increment Function **55**
- relay **11, 25, 63, 94**
 - contact rating **13, 25**
 - Form-C **63**
 - programming **63**
- relay module **16**
- Release Circuit **57**
- Release Stage **90**
- Release Stage NAC **57**
- releasing circuit **13**
- releasing solenoids **11, 12**
- Remote **35**
- remote LCD annunciator **16, 35**
 - installation **35**
 - programming **37, 75**
 - specifications **35**
 - wiring **36**
- remote station service **30**
- Remote Station Transmitter Connection to FACP Dry Contacts **128**
- Reset **12, 14, 84**
- resettable power **11, 14, 25**
 - current **25**
 - maximum current **14**
- reverse polarity circuit
 - see also 4XTM **15**

S

- Silence Inhibit **59**
- Silence Inhibit Timer **90**
- Silenceable
 - Output **58**
- silenceable circuits
 - synchronized signals **58**
- soak timer **65, 66, 90**
- sounder **12, 14, 15**
- sprinkler standards
 - NFPA **12**
- Steady **61**
- strokes **12, 61**
 - maximum **61**
- Style B **13, 22**
 - see also Class B **11**
- Style D **15, 22, 28**
- Style Y **13**
 - see also Class B **11**
- Style Z **15, 28**
- subscreen **46**
- supervision

- transmitter option module placement **29**
- supervisory **11, 88**
 - piezo pulse rate **15**
- supervisory relay **25**
 - contact rating **13**
- synchronization **61**
- synchronized signals **61**
 - and silenceable circuits **58**
- system current calculations **99**
- System Settings **95**
- System Setup **64**

T

- Temporal **61**
- Time setting **68**
- Time-Date
 - Maintenance Level **83**
- Time-Date setting **64, 68**
- timers **64, 65, 95**
- transmitter module **15, 29**
 - installation **29**
 - operation **29**
 - specifications **30**
- transmitter option module
 - placement supervision **29**
- trim ring **16**
- trouble **86**
 - piezo pulse rate **15**
- Trouble Input
 - Auxiliary **13**
- trouble relay **11, 25**
 - contact rating **13**
 - fail-safe **25**
- Trouble Reminder **64, 70, 90**
- type
 - outputs **56**
 - zone **50**

U

- UL
 - wiring requirements **26**

V

- View Events **77**

W

- Walktest **78, 90**
 - audible **78**
 - Maintenance Level **82**
 - operation **90**
 - silent **78**
- Waterflow Delay timer **65, 66, 90**
- waterflow/supervisory circuit **23**
- Wire Requirements **132**

wiring

- ANN-BUS **31**
- class A converter module **28**
- Class A IDC **28**
- Class A NAC **28**
- combination waterflow/supervisory **23**
- IDC **22**
- NAC **24**
- nonpower-limited **26**
- power-limited **26**
- UL requirements **26**

Z

Zone

- type **50**

Zone Setup

- Maintenance Level **81**

zone type

- inputs **51**

Manufacturer Warranties and Limitation of Liability

Manufacturer Warranties. Subject to the limitations set forth herein, Manufacturer warrants that the Products manufactured by it in its Northford, Connecticut facility and sold by it to its authorized Distributors shall be free, under normal use and service, from defects in material and workmanship for a period of thirty six months (36) months from the date of manufacture (effective Jan. 1, 2009). The Products manufactured and sold by Manufacturer are date stamped at the time of production. Manufacturer does not warrant Products that are not manufactured by it in its Northford, Connecticut facility but assigns to its Distributor, to the extent possible, any warranty offered by the manufacturer of such product. This warranty shall be void if a Product is altered, serviced or repaired by anyone other than Manufacturer or its authorized Distributors. This warranty shall also be void if there is a failure to maintain the Products and the systems in which they operate in proper working conditions.

MANUFACTURER MAKES NO FURTHER WARRANTIES, AND DISCLAIMS ANY AND ALL OTHER WARRANTIES, EITHER EXPRESSED OR IMPLIED, WITH RESPECT TO THE PRODUCTS, TRADEMARKS, PROGRAMS AND SERVICES RENDERED BY MANUFACTURER INCLUDING WITHOUT LIMITATION, INFRINGEMENT, TITLE, MERCHANTABILITY, OR FITNESS FOR ANY PARTICULAR PURPOSE. MANUFACTURER SHALL NOT BE LIABLE FOR ANY PERSONAL INJURY OR DEATH WHICH MAY ARISE IN THE COURSE OF, OR AS A RESULT OF, PERSONAL, COMMERCIAL OR INDUSTRIAL USES OF ITS PRODUCTS.

This document constitutes the only warranty made by Manufacturer with respect to its products and replaces all previous warranties and is the only warranty made by Manufacturer. No increase or alteration, written or verbal, of the obligation of this warranty is authorized. Manufacturer does not represent that its products will prevent any loss by fire or otherwise.

Warranty Claims. Manufacturer shall replace or repair, at Manufacturer's discretion, each part returned by its authorized Distributor and acknowledged by Manufacturer to be defective, provided that such part shall have been returned to Manufacturer with all charges prepaid and the authorized Distributor has completed Manufacturer's Return Material Authorization form. The replacement part shall come from Manufacturer's stock and may be new or refurbished. THE FOREGOING IS DISTRIBUTOR'S SOLE AND EXCLUSIVE REMEDY IN THE EVENT OF A WARRANTY CLAIM.

Warn-HL-08-2009.fm



World Headquarters
12 Clintonville Road
Northford, CT 06472-1610 USA
203-484-7161
fax 203-484-7118

www.notifier.com

ISO 9001
CERTIFIED
ENGINEERING & MANUFACTURING
QUALITY SYSTEMS